HDF5 User's Guide

Release 1.8.7
May 2011

Copyright Notice and License Terms for HDF5 (Hierarchical Data Format 5) Software Library and Utilities

HDF5 (Hierarchical Data Format 5) Software Library and Utilities
Copyright 2006-2011 by The HDF Group.

NCSA HDF5 (Hierarchical Data Format 5) Software Library and Utilities
Copyright 1998-2006 by the Board of Trustees of the University of Illinois.

All rights reserved.

Redistribution and use in source and binary forms, with or without modification, are permitted for any purpose (including commercial purposes) provided that the following conditions are met:

1. Redistributions of source code must retain the above copyright notice, this list of conditions, and the following disclaimer.
2. Redistributions in binary form must reproduce the above copyright notice, this list of conditions, and the following disclaimer in the documentation and/or materials provided with the distribution.
3. In addition, redistributions of modified forms of the source or binary code must carry prominent notices stating that the original code was changed and the date of the change.
4. All publications or advertising materials mentioning features or use of this software are asked, but not required, to acknowledge that it was developed by The HDF Group and by the National Center for Supercomputing Applications at the University of Illinois at Urbana-Champaign and credit the contributors.
5. Neither the name of The HDF Group, the name of the University, nor the name of any Contributor may be used to endorse or promote products derived from this software without specific prior written permission from The HDF Group, the University, or the Contributor, respectively.

DISCLAIMER: THIS SOFTWARE IS PROVIDED BY THE HDF GROUP AND THE CONTRIBUTORS "AS IS" WITH NO WARRANTY OF ANY KIND, EITHER EXPRESSED OR IMPLIED. In no event shall The HDF Group or the Contributors be liable for any damages suffered by the users arising out of the use of this software, even if advised of the possibility of such damage.

Contributors: National Center for Supercomputing Applications (NCSA) at the University of Illinois, Fortner Software, Unidata Program Center (netCDF), The Independent JPEG Group (JPEG), Jean-loup Gailly and Mark Adler (gzip), and Digital Equipment Corporation (DEC).

Portions of HDF5 were developed with support from the Lawrence Berkeley National Laboratory (LBNL) and the United States Department of Energy under Prime Contract No. DE-AC02-05CH11231.

Portions of HDF5 were developed with support from the University of California, Lawrence Livermore National Laboratory (UC LLNL). The following statement applies to those portions of the product and must be retained in any redistribution of source code, binaries, documentation, and/or accompanying materials:

This work was partially produced at the University of California, Lawrence Livermore National Laboratory (UC LLNL) under contract no. W-7405-ENG-48 (Contract 48) between the U.S. Department of Energy (DOE) and The Regents of the University of California (University) for the operation of UC LLNL.

DISCLAIMER: This work was prepared as an account of work sponsored by an agency of the United States Government. Neither the United States Government nor the University of California nor any of their employees, makes any warranty, express or implied, or assumes any liability or responsibility for the accuracy, completeness, or usefulness of any information, apparatus, product, or process disclosed, or represents that its use would not infringe privately- owned rights. Reference herein to any specific commercial products, process, or service by trade name, trademark, manufacturer, or otherwise, does not necessarily constitute or imply its endorsement, recommendation, or favoring by the United States Government or the University of California. The views and opinions of authors expressed herein do not necessarily state or reflect those of the United States Government or the University of California, and shall not be used for advertising or product endorsement purposes.

The HDF Group Help Desk: help@hdfgroup.org
Describes HDF5 Release 1.8.7, May 2011.

Table of Contents

HDF5 User's Guide Update Status	
Part I: The Broad View	1
Chapter 1: The HDF5 Data Model and File Structure	3
Chapter 2: The HDF5 Library and Programming Model	21
Part II: The Specifics	39
Chapter 3: The HDF5 File	41
Chapter 4: HDF5 Groups	69
Chapter 5: HDF5 Datasets	93
Chapter 6: HDF5 Datatypes	151
Chapter 7: HDF5 Dataspaces and Partial I/O	233
Chapter 8: HDF5 Attributes	271
Chapter 9: HDF5 Error Handling	285
Part III: Additional Resources	299
Chapter 10: Additional Resources	301

HDF5 User's Guide Update Status

The *HDF5 User's Guide* has been updated for HDF5 Release 1.8.7. These updates have been made since the 1.8.6 version of this document was published in February 2011.

The main update is the addition of the external link cache functions. These new functions are listed in the "HDF5 Groups" chapter.

We welcome feedback on the documentation. Please send your comments to docs@hdfgroup.org.

Last modified: 11 May 2011

Part I

The Broad View

Chapter 1

The HDF5 Data Model and File Structure

1.1. Introduction

The Hierarchical Data Format (HDF) implements a model for managing and storing data. The model includes an abstract data model and an abstract storage model (the data format), and libraries to implement the abstract model and to map the storage model to different storage mechanisms. The HDF5 library provides a programming interface to a concrete implementation of the abstract models. The library also implements a model of data transfer, i.e., efficient movement of data from one stored representation to another stored representation. The figure below illustrates the relationships between the models and implementations. This chapter explains these models in detail.

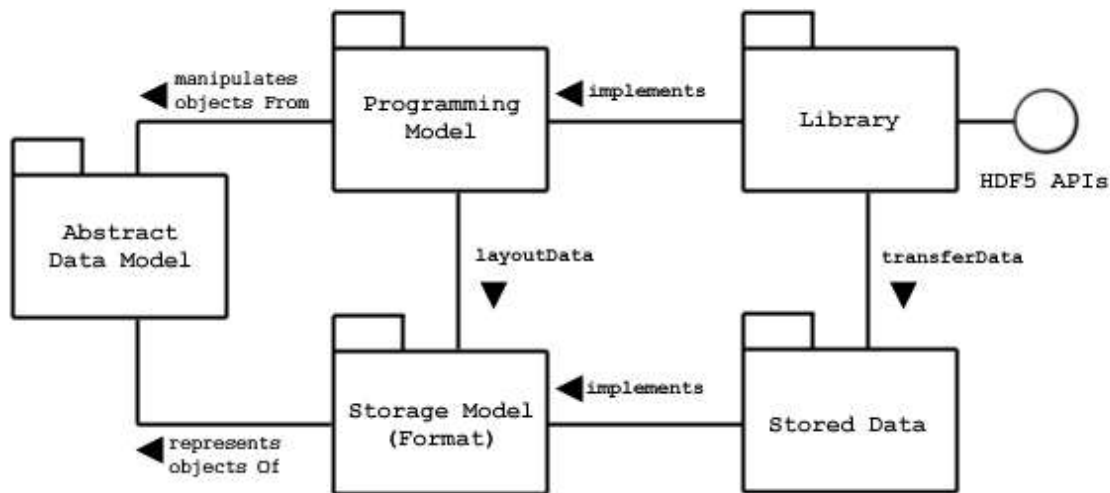

Figure 1. HDF5 models and implementations

The *Abstract Data Model* is a conceptual model of data, data types, and data organization. The abstract data model is independent of storage medium or programming environment. The *Storage Model* is a standard representation for the objects of the abstract data model. The *HDF5 File Format Specification* defines the storage model.

The *Programming Model* is a model of the computing environment and includes platforms from small single systems to large multiprocessors and clusters. The programming model manipulates (instantiates, populates, and retrieves) objects from the abstract data model.

The *Library* is the concrete implementation of the programming model. The Library exports the HDF5 APIs as its interface. In addition to implementing the objects of the abstract data model, the Library manages data transfers from one stored form to another. Data transfer examples include reading from disk to memory and writing from memory to disk.

Stored Data is the concrete implementation of the storage model. The storage model is mapped to several storage mechanisms including single disk files, multiple files (family of files), and memory representations.

The HDF5 Library is a C module that implements the programming model and abstract data model. The HDF5 Library calls the operating system or other storage management software (e.g., the MPI/IO Library) to store and retrieve persistent data. The HDF5 Library may also link to other software such as filters for compression. The HDF5 Library is linked to an application program which may be written in C, C++, Fortran, or Java. The application program implements problem specific algorithms and data structures and calls the HDF5 Library to store and retrieve data. The figure below shows the dependencies of these modules.

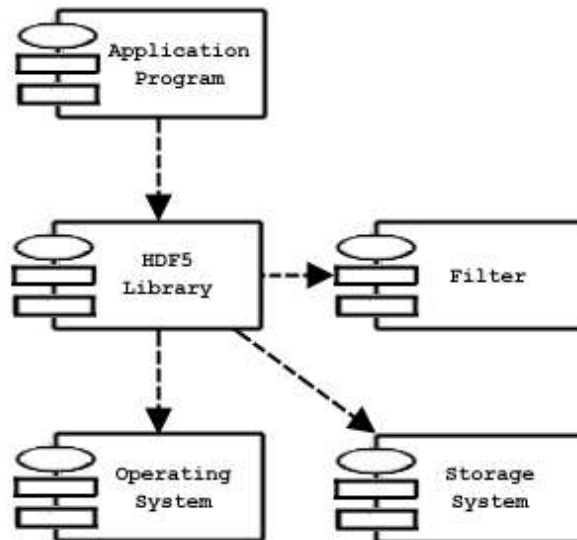

Figure 2. The library, the application program, and other modules

It is important to realize that each of the software components manages data using models and data structures that are appropriate to the component. When data is passed between layers (during storage or retrieval), it is transformed from one representation to another. The figure below suggests some of the kinds of data structures used in the different layers.

The *Application Program* uses data structures that represent the problem and algorithms including variables, tables, arrays, and meshes among other data structures. Depending on its design and function, an application may have quite a few different kinds of data structures and different numbers and sizes of objects.

The HDF5 Library implements the objects of the HDF5 abstract data model. Some of these objects include groups, datasets, and attributes. The application program maps the application data structures to a hierarchy of HDF5 objects. Each application will create a mapping best suited to its purposes.

The objects of the HDF5 abstract data model are mapped to the objects of the HDF5 storage model, and stored in a storage medium. The stored objects include header blocks, free lists, data blocks, B-trees, and other objects. Each group or dataset is stored as one or more header and data blocks. See the *HDF5 File Format Specification*

for more information on how these objects are organized. The HDF5 Library can also use other libraries and modules such as compression.

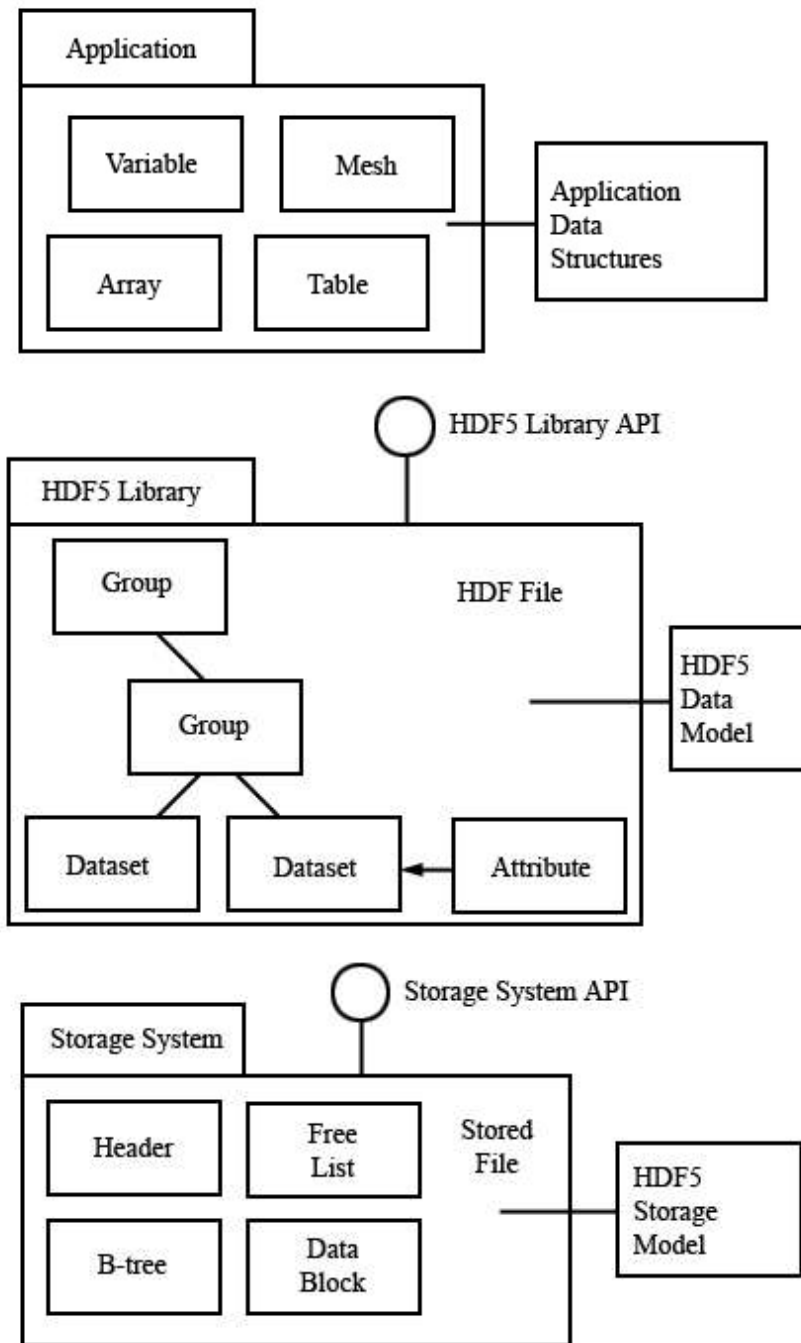

Figure 3. Data structures in different layers

The important point to note is that there is not necessarily any simple correspondence between the objects of the application program, the abstract data model, and those of the *Format Specification*. The organization of the data of application program, and how it is mapped to the HDF5 abstract data model is up to the application developer. The application program only needs to deal with the library and the abstract data model. Most applications need

not consider any details of the *HDF5 File Format Specification* or the details of how objects of abstract data model are translated to and from storage.

1.2. The Abstract Data Model

The abstract data model (ADM) defines concepts for defining and describing complex data stored in files. The ADM is a very general model which is designed to conceptually cover many specific models. Many different kinds of data can be mapped to objects of the ADM, and therefore stored and retrieved using HDF5. The ADM is not, however, a model of any particular problem or application domain. Users need to map their data to the concepts of the ADM.

The key concepts include:

- *File* - a contiguous string of bytes in a computer store (memory, disk, etc.), and the bytes represent zero or more objects of the model
- *Group* - a collection of objects (including groups)
- *Dataset* - a multidimensional array of data elements with attributes and other metadata
- *Dataspace* - a description of the dimensions of a multidimensional array
- *Datatype* - a description of a specific class of data element including its storage layout as a pattern of bits
- *Attribute* - a named data value associated with a group, dataset, or named datatype
- *Property List* - a collection of parameters (some permanent and some transient) controlling options in the library
- *Link* - the way objects are connected

These key concepts are described in more detail below.

1.2.1. File

Abstractly, an HDF5 file is a container for an organized collection of objects. The objects are groups, datasets, and other objects as defined below. The objects are organized as a rooted, directed graph. Every HDF5 file has at least one object, the root group. See the figure below. All objects are members of the root group or descendents of the root group.

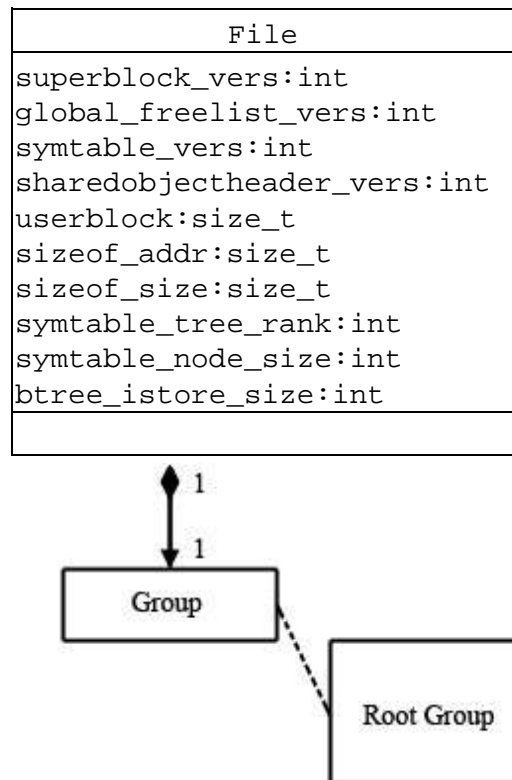

Figure 4. The HDF5 file

HDF5 objects have a unique identity *within a single HDF5 file* and can be accessed only by its names within the hierarchy of the file. HDF5 objects in different files do not necessarily have unique identities, and it is not possible to access a permanent HDF5 object except through a file. See the section “The Structure of an HDF5 File” below for an explanation of the structure of the HDF5 file.

When the file is created, the *file creation properties* specify settings for the file. The file creation properties include version information and parameters of global data structures. When the file is opened, the *file access properties* specify settings for the current access to the file. File access properties include parameters for storage drivers and parameters for caching and garbage collection. The file creation properties are set permanently for the life of the file, and the file access properties can be changed by closing and reopening the file.

An HDF5 file can be “mounted” as part of another HDF5 file. This is analogous to Unix file system mounts. The root of the mounted file is attached to a group in the mounting file, and all the contents can be accessed as if the mounted file were part of the mounting file.

1.2.2. Group

An HDF5 group is analogous to a file system directory. Abstractly, a group contains zero or more objects, and every object must be a member of at least one group. The root group is a special case; it may not be a member of any group.

Group membership is actually implemented via link objects. See the figure below. A link object is owned by a group and points to a *named object*. Each link has a *name*, and each link points to exactly one object. Each named object has at least one and possibly many links to it.

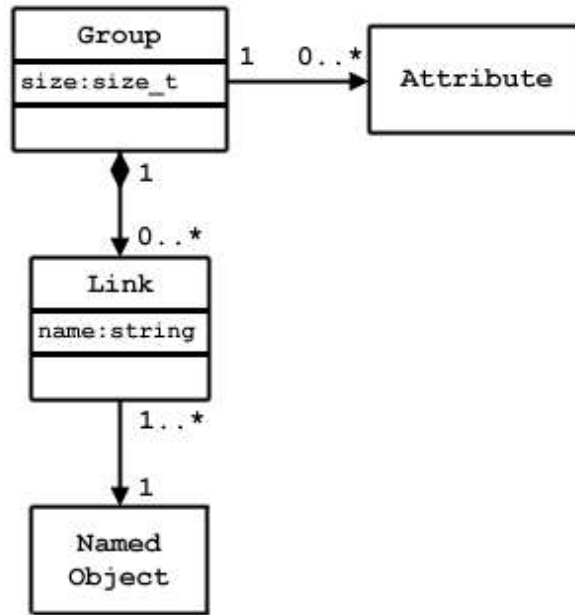

Figure 5. Group membership via link objects

There are three classes of named objects: group, dataset, and named datatype. See the figure below. Each of these objects is the member of at least one group, and this means there is at least one link to it.

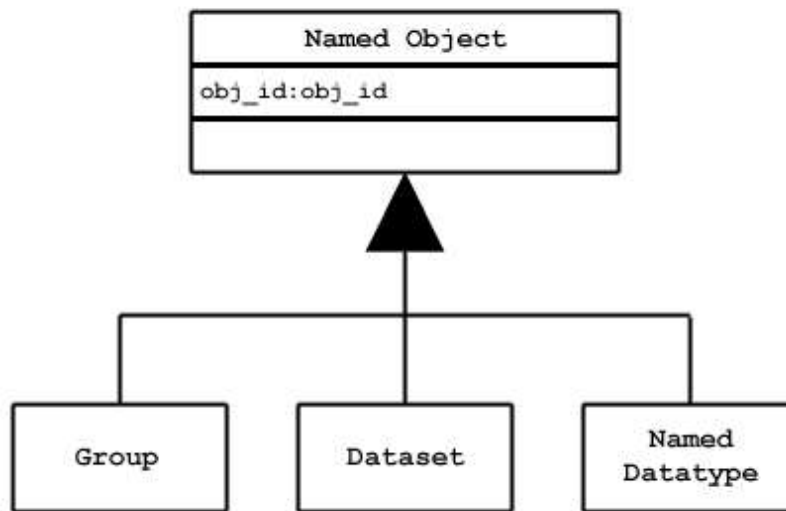

Figure 6. Classes of named objects

1.2.3. Dataset

An HDF5 dataset is a multidimensional (rectangular) array of data elements. See the figure below. The shape of the array (number of dimensions, size of each dimension) is described by the dataspace object (described in the next section below).

A data element is a single unit of data which may be a number, a character, an array of numbers or characters, or a record of heterogeneous data elements. A data element is a set of bits. The layout of the bits is described by the datatype (see below).

The dataspace and datatype are set when the dataset is created, and they cannot be changed for the life of the dataset. The *dataset creation properties* are set when the dataset is created. The dataset creation properties include the fill value and storage properties such as chunking and compression. These properties cannot be changed after the dataset is created.

The dataset object manages the storage and access to the data. While the data is conceptually a contiguous rectangular array, it is physically stored and transferred in different ways depending on the storage properties and the storage mechanism used. The actual storage may be a set of compressed chunks, and the access may be through different storage mechanisms and caches. The dataset maps between the conceptual array of elements and the actual stored data.

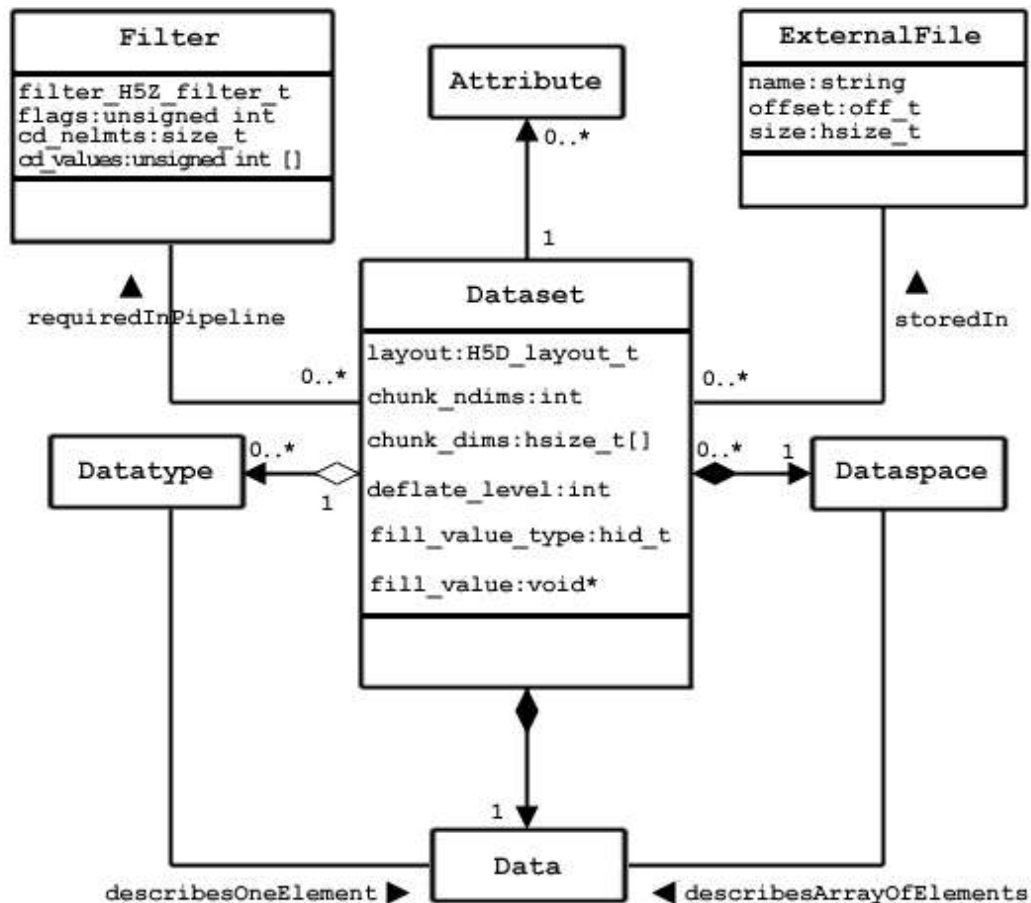

Figure 7. The dataset

1.2.4. Dataspace

The HDF5 dataspace describes the layout of the elements of a multidimensional array. Conceptually, the array is a hyper-rectangle with one to 32 dimensions. HDF5 dataspaces can be extendable. Therefore, each dimension has a current size and a maximum size, and the maximum may be unlimited. The dataspace describes this hyper-rectangle: it is a list of dimensions with the current and maximum (or unlimited) sizes. See the figure below.

Dataspace
rank:int
current_size:hsize_t[rank]
maximum_size:hsize_t[rank]

Figure 8. The dataspace

Dataspace objects are also used to describe hyperslab selections from a dataset. Any subset of the elements of a dataset can be selected for read or write by specifying a set of hyperslabs. A non-rectangular region can be selected by the union of several (rectangular) dataspace objects.

1.2.5. Datatype

The HDF5 datatype object describes the layout of a single data element. A data element is a single element of the array; it may be a single number, a character, an array of numbers or characters, or other data. The datatype object describes the storage layout of this data.

Data types are categorized into 11 classes of datatype. Each class is interpreted according to a set of rules and has a specific set of properties to describe its storage. For instance, floating point numbers have exponent position and sizes which are interpreted according to appropriate standards for number representation. Thus, the datatype class tells what the element means, and the datatype describes how it is stored.

The figure below shows the classification of datatypes. Atomic datatypes are indivisible. each may be a single object; a number, a string, or some other objects. Composite datatypes are composed of multiple elements of atomic datatypes. In addition to the standard types, users can define additional datatypes such as a 24-bit integer or a 16-bit float.

A dataset or attribute has a single datatype object associated with it. See Figure 7 above. The datatype object may be used in the definition of several objects, but by default, a copy of the datatype object will be private to the dataset.

Optionally, a datatype object can be stored in the HDF5 file. The datatype is linked into a group, and therefore given a name. A *named datatype* can be opened and used in any way that a datatype object can be used.

The details of datatypes, their properties, and how they are used are explained in the “HDF5 Datatypes” chapter.

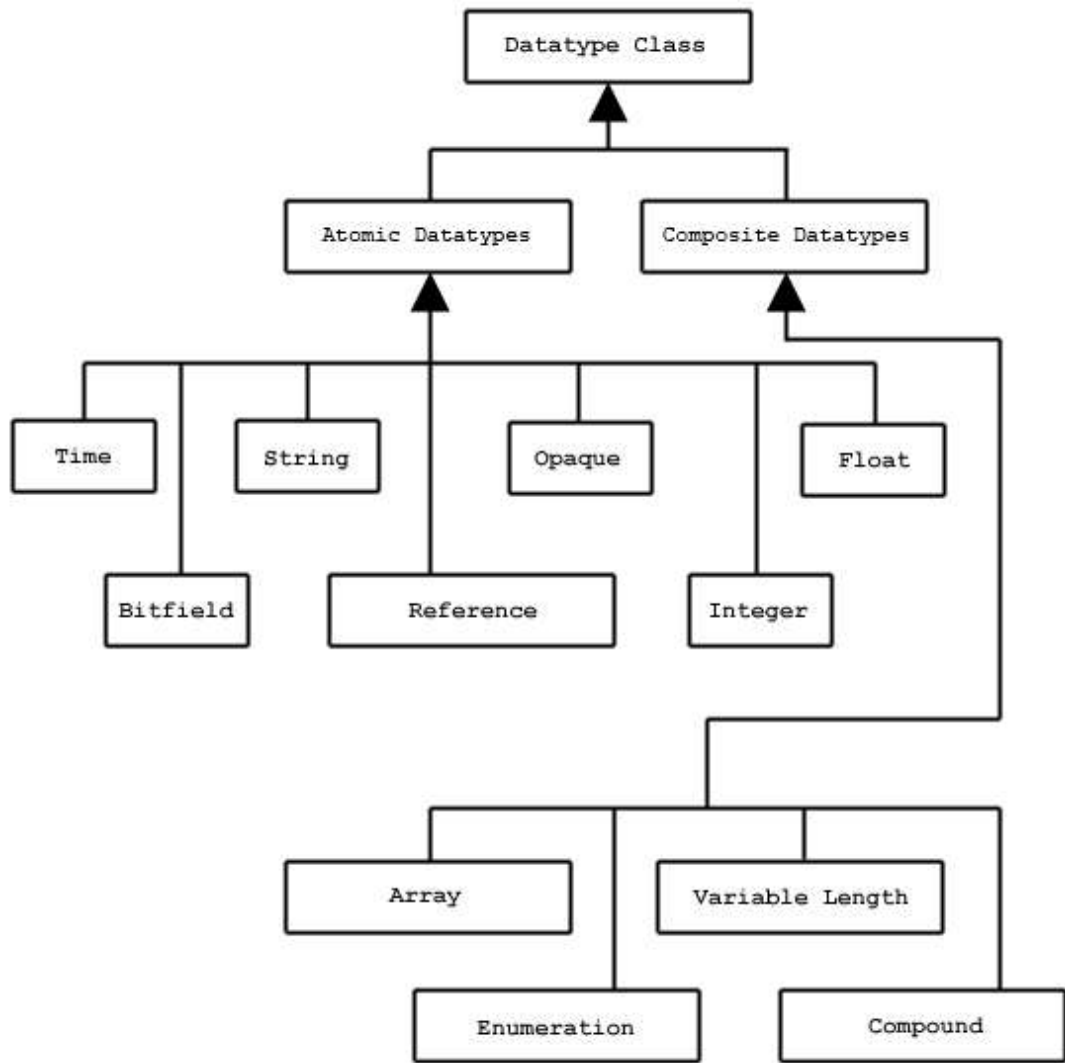

Figure 9. Datatype classifications

1.2.6. Attribute

Any HDF5 named data object (group, dataset, or named datatype) may have zero or more user defined attributes. Attributes are used to document the object. The attributes of an object are stored with the object.

An HDF5 attribute has a name and data. The data portion is similar in structure to a dataset: a dataspace defines the layout of an array of data elements, and a datatype defines the storage layout and interpretation of the elements. See the figure below.

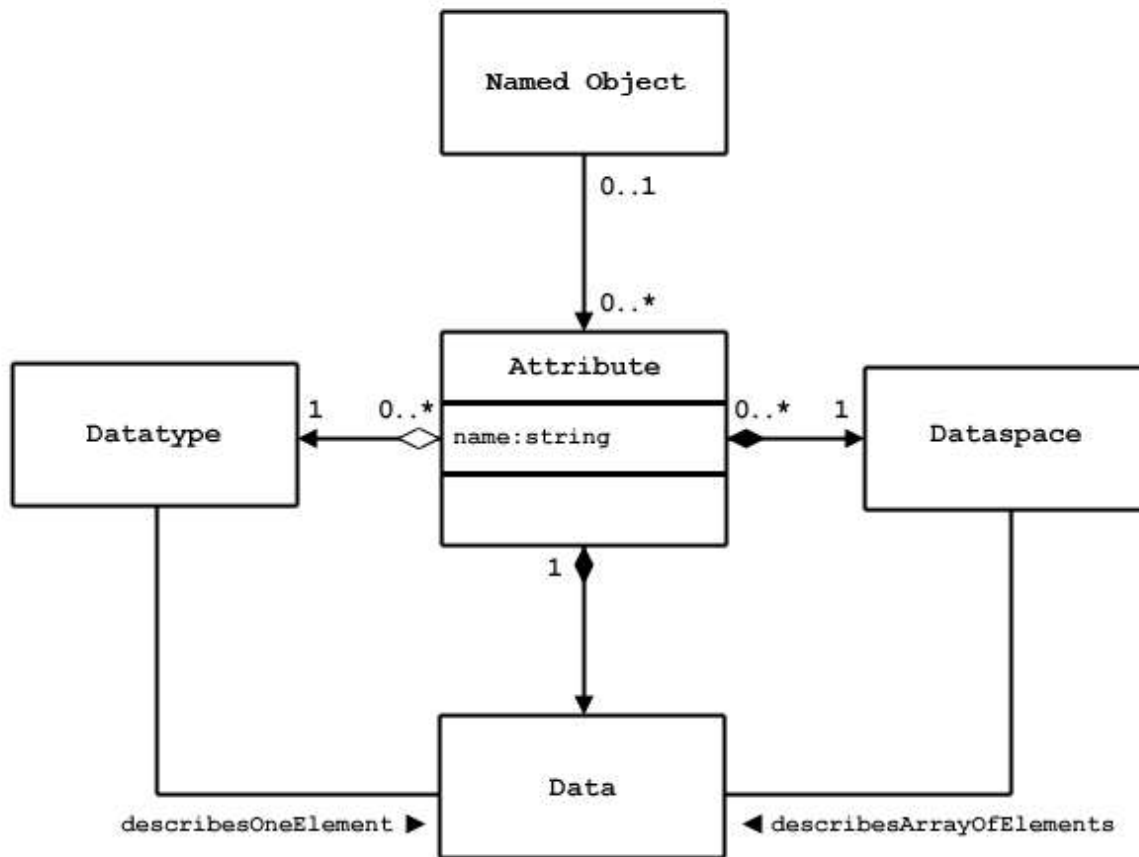

Figure 10. Attribute data elements

In fact, an attribute is very similar to a dataset with the following limitations:

- An attribute can only be accessed via the object
- Attribute names are significant only within the object
- An attribute should be a small object
- The data of an attribute must be read or written in a single access (partial reading or writing is not allowed)
- Attributes do not have attributes

Note that the value of an attribute can be an *object reference*. A shared attribute or an attribute that is a large array can be implemented as a reference to a dataset.

The name, dataspace, and datatype of an attribute are specified when it is created and cannot be changed over the life of the attribute. An attribute can be opened by name, by index, or by iterating through all the attributes of the object.

1.2.7. Property List

HDF5 has a generic property list object. Each list is a collection of *name-value* pairs. Each class of property list has a specific set of properties. Each property has an implicit name, a datatype, and a value. See the figure below. A property list object is created and used in ways similar to the other objects of the HDF5 library.

Property Lists are attached to the object in the library, they can be used by any part of the library. Some properties are permanent (e.g., the chunking strategy for a dataset), others are transient (e.g., buffer sizes for data transfer). A common use of a Property List is to pass parameters from the calling program to a VFL driver or a module of the pipeline.

Property lists are conceptually similar to attributes. Property lists are information relevant to the behavior of the library while attributes are relevant to the user's data and application.

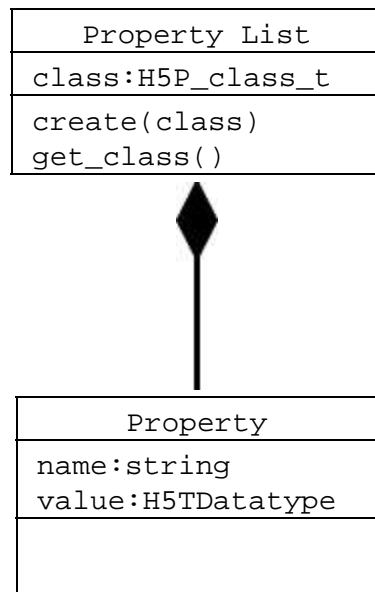

Figure 11. The property list

Property lists are used to control optional behavior for file creation, file access, dataset creation, dataset transfer (read, write), and file mounting. Some property list classes are shown in the table below. Details of the different property lists are explained in the relevant sections of this document.

Table 1. Property list classes and their usage

Property List Class	Used	Examples
H5P_FILE_CREATE	Properties for file creation.	Set size of user block.
H5P_FILE_ACCESS	Properties for file access.	Set parameters for VFL driver. An example is MPI I/O.
H5P_DATASET_CREATE	Properties for dataset creation.	Set chunking, compression, or fill value.
H5P_DATASET_XFER	Properties for raw data transfer (read and write).	Tune buffer sizes or memory management.
H5P_FILE_MOUNT	Properties for file mounting.	

1.2.8. Link

This section is under construction.

1.3. The HDF5 Storage Model

1.3.1. The Abstract Storage Model: the HDF5 Format Specification

The *HDF5 File Format Specification* defines how HDF5 objects and data are mapped to a *linear address space*. The address space is assumed to be a contiguous array of bytes stored on some random access medium.¹ The format defines the standard for how the objects of the abstract data model are mapped to linear addresses. The stored representation is self-describing in the sense that the format defines all the information necessary to read and reconstruct the original objects of the abstract data model.

The *HDF5 File Format Specification* is organized in three parts:

1. **Level 0:** File signature and super block
2. **Level 1:** File infrastructure
 - a. **Level 1A:** B-link trees and B-tree nodes
 - b. **Level 1B:** Group
 - c. **Level 1C:** Group entry
 - d. **Level 1D:** Local heaps
 - e. **Level 1E:** Global heap
 - f. **Level 1F:** Free-space index
3. **Level 2:** Data object
 - a. **Level 2A:** Data object headers
 - b. **Level 2B:** Shared data object headers
 - c. **Level 2C:** Data object data storage

The **Level 0** specification defines the header block for the file. Header block elements include a signature, version information, key parameters of the file layout (such as which VFL file drivers are needed), and pointers to the rest of the file. **Level 1** defines the data structures used throughout the file: the B-trees, heaps, and groups. **Level 2** defines the data structure for storing the data objects and data. In all cases, the data structures are completely specified so that every bit in the file can be faithfully interpreted.

It is important to realize that the structures defined in the HDF5 file format are not the same as the abstract data model: the object headers, heaps, and B-trees of the file specification are not represented in the abstract data model. The format defines a number of objects for managing the storage including header blocks, B-trees, and heaps. The *HDF5 File Format Specification* defines how the abstract objects (for example, groups and datasets) are represented as headers, B-tree blocks, and other elements.

The HDF5 Library implements operations to write HDF5 objects to the linear format and to read from the linear format to create HDF5 objects. It is important to realize that a single HDF5 abstract object is usually stored as several objects. A dataset, for example, might be stored in a header and in one or more data blocks, and these objects might not be contiguous on the hard disk.

1.3.2. Concrete Storage Model

The HDF5 file format defines an abstract linear address space. This can be implemented in different storage media such as a single file or multiple files on disk or in memory. The HDF5 Library defines an open interface called the *Virtual File Layer* (VFL). The VFL allows different concrete storage models to be selected.

The VFL defines an abstract model, an API for random access storage, and an API to plug in alternative VFL driver modules. The model defines the operations that the VFL driver must and may support, and the plug-in API enables the HDF5 Library to recognize the driver and pass it control and data.

The HDF5 Library defines six VFL drivers: serial unbuffered, serial buffered, memory, MPI/IO, family of files, and split files. See the figure and table below. Other drivers such as a socket stream driver or a Globus driver may also be available, and new drivers can be added.

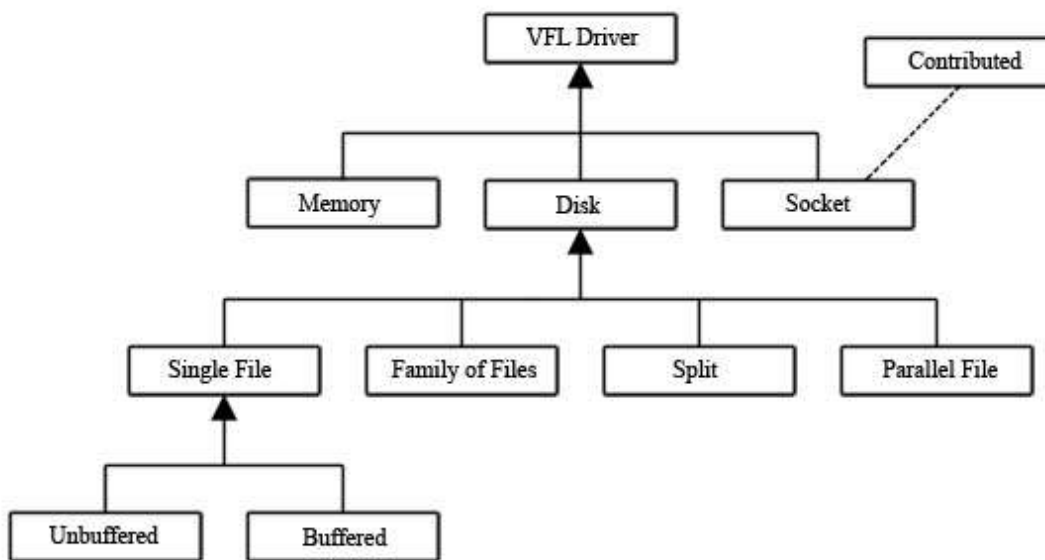

Figure 12. Conceptual hierarchy of VFL drivers

Each driver isolates the details of reading and writing storage so that the rest of the HDF5 Library and user program can be almost the same for different storage methods. The exception to this rule is that some VFL drivers need information from the calling application. This information is passed using property lists. For example, the MPI/IO driver requires certain control information that must be provided by the application.

Table 2. VFL drivers

Driver	Description
Unbuffered Posix I/O (H5FD_SEC2) <i>Default</i>	Uses Posix file-system functions like read and write to perform I/O to a single file.
Buffered single file (H5FD_STDIO)	This driver uses functions from the Unix/Posix 'stdio.h' to perform buffered I/O to a single file.
Memory (H5FD_CORE)	This driver performs I/O directly to memory. The I/O is memory to memory operations, but the 'file' is not persistent.
MPI/IO (H5FD_MPIO)	This driver implements parallel file IO using MPI and MPI-IO
Family of files (H5FD_FAMILY)	The address space is partitioned into pieces and sent to separate storage locations using an underlying driver of the user's choice.
Split File (H5FD_SPLIT)	The format address space is split into metadata and raw data, and each is mapped onto separate storage using underlying drivers of the user's choice.
Stream <i>Contributed</i>	This driver reads and writes the bytes to a Unix style socket. This socket can also be a network channel. This is an example of a user-defined VFL driver.

1.4. The Structure of an HDF5 File

1.4.1. Overall File Structure

An HDF5 file is organized as a rooted, directed graph. Named data objects are the nodes of the graph, and links are the directed arcs. Each arc of the graph has a name, and the root group has the name “/”. Objects are created and then inserted into the graph with the link operation which creates a named link from a group to the object. For example, the figure below illustrates the structure of an HDF5 file when one dataset is created. An object can be the target of more than one link. The names on the links must be unique within each group, but there may be many links with the same name in different groups. Link names are unambiguous: some ancestor will have a different name, or they are the same object. The graph is navigated with path names similar to Unix file systems. An object can be opened with a full path starting at the root group or with a relative path and a starting node (group). Note that all paths are relative to a single HDF5 file. In this sense, an HDF5 file is analogous to a single Unix file system.²



a) Newly created file: one group, /

b) Create a dataset called /dset1
(`HDcreate(..., "/dset2", ...)`)

Figure 13. An HDF5 file with one dataset

It is important to note that, just like the Unix file system, HDF5 objects do not have *names*. The names are associated with *paths*. An object has a unique (within the file) *object ID*, but a single object may have many names because there may be many paths to the same object. An object can be renamed (moved to another group) by adding and deleting links. In this case, the object itself never moves. For that matter, membership in a group has no implication for the physical location of the stored object.

Deleting a link to an object does not necessarily delete the object. The object remains available as long as there is at least one link to it. After all the links to an object are deleted, it can no longer be opened although the storage may or may not be reclaimed.³

It is important to realize that the linking mechanism can be used to construct very complex graphs of objects. For example, it is possible for an object to be shared between several groups and even to have more than one name in the same group. It is also possible for a group to be a member of itself or to be in a “cycle” in the graph. An example of a cycle is where a child is the parent of one of its own ancestors.

1.4.2. HDF5 Path Names and Navigation

The structure of the file constitutes the name space for the objects in the file. A path name is a string of components separated by '/'. Each component is the name of a link or the special character "." for the current group. Link names (components) can be any string of ASCII characters not containing '/' (except the string "." which is reserved). However, users are advised to avoid the use of punctuation and non-printing characters because they may create problems for other software. The figure below gives a BNF grammar for HDF5 path names.

```

PathName ::= AbsolutePathName | RelativePathName
Separator ::= "/" [ "/" ] *
AbsolutePathName ::= Separator [ RelativePathName ]
RelativePathName ::= Component [ Separator RelativePathName ] *
Component ::= "." | Name
Name ::= Character+ - { "." }
Character ::= { c: c in { { legal ASCII characters } - { '/' } }

```

Figure 14. A BNF grammar for path names

An object can always be addressed by a *full or absolute path* which would start at the root group. As already noted, a given object can have more than one full path name. An object can also be addressed by a relative path which would start at a group and include the path to the object.

The structure of an HDF5 file is “self-describing.” This means that it is possible to navigate the file to discover all the objects in the file. Basically, the structure is traversed as a graph starting at one node and recursively visiting the nodes of the graph.

1.4.3. Examples of HDF5 File Structures

The figure below shows some possible HDF5 file structures with groups and datasets. Part a of the figure shows the structure of a file with three groups. Part b of the figure shows a dataset created in “/group1”. Part c shows the structure after a dataset called dset2 has been added to the root group. Part d the structure after another group and dataset have been added.

a) Three groups; two are members of the root group, /group1 and /group2

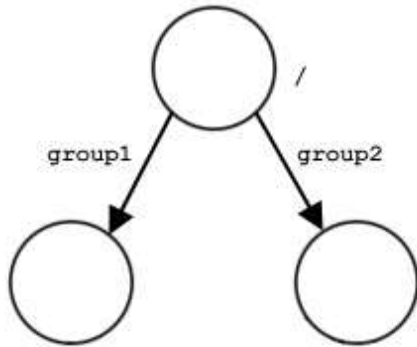

b) Create a dataset in /group1: /group1/dset1

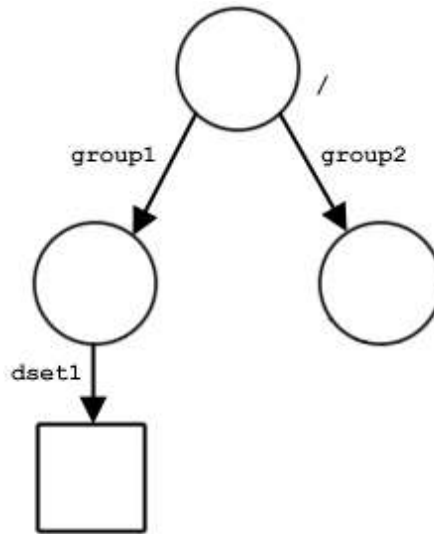

c) Another dataset, a member of the root group: /dset2

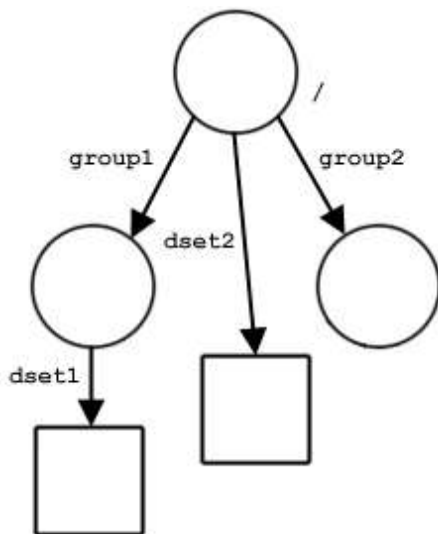

d) And another group and dataset, reusing object names: /group2/group2/dset2

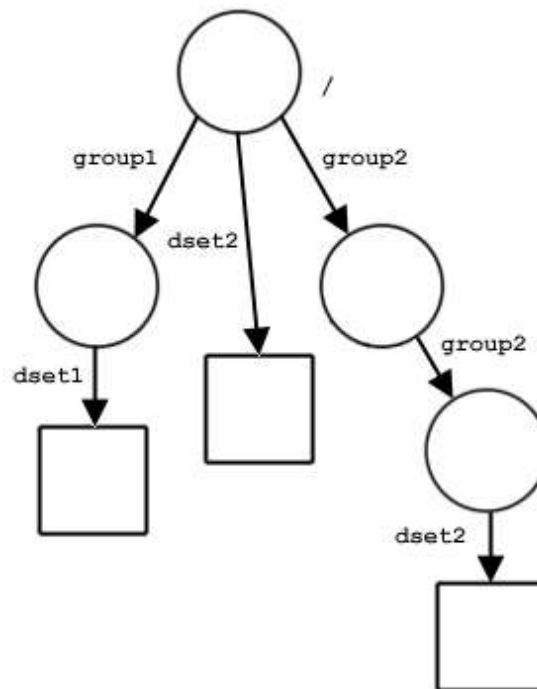

Figure 15. Examples of HDF5 file structures with groups and datasets

¹HDF5 requires random access to the linear address space. For this reason it is not well suited for some data media such as streams.

²It could be said that HDF5 extends the organizing concepts of a file system to the internal structure of a single file.

³As of HDF5-1.4, the storage used for an object is reclaimed, even if all links are deleted.

Chapter 2

The HDF5 Library and Programming Model

2.1. Introduction

The HDF5 Library implements the HDF5 abstract data model and storage model. These models were described in the preceding chapter, “The HDF5 Data Model”.

Two major objectives of the HDF5 products are to provide tools that can be used on as many computational platforms as possible (portability), and to provide a reasonably object-oriented data model and programming interface.

To be as portable as possible, the HDF5 Library is implemented in portable C. C is not an object-oriented language, but the library uses several mechanisms and conventions to implement an object model.

One mechanism the HDF5 library uses is to implement the objects as data structures. To refer to an object, the HDF5 library implements its own pointers. These pointers are called identifiers. An identifier is then used to invoke operations on a specific instance of an object. For example, when a group is opened, the API returns a group identifier. This identifier is a reference to that specific group and will be used to invoke future operations on that group. The identifier is valid only within the context it is created and remains valid until it is closed or the file is closed. This mechanism is essentially the same as the mechanism that C++ or other object-oriented languages use to refer to objects except that the syntax is C.

Similarly, object-oriented languages collect all the methods for an object in a single name space. An example is the methods of a C++ class. The C language does not have any such mechanism, but the HDF5 Library simulates this through its API naming convention. API function names begin with a common prefix that is related to the class of objects that the function operates on. The table below lists the HDF5 objects and the standard prefixes used by the corresponding HDF5 APIs. For example, functions that operate on datatype objects all have names beginning with H5T.

Table 1. The HDF5 API naming scheme

Prefix	Operates on
H5A	Attributes
H5D	Datasets
H5E	Error reports
H5F	Files
H5G	Groups
H5I	Identifiers
H5L	Links
H5O	Objects
H5P	Property lists
H5R	References
H5S	Dataspaces
H5T	Datatypes
H5Z	Filters

2.2. The HDF5 Programming Model

In this section we introduce the HDF5 programming model by means of a series of short code samples. These samples illustrate a broad selection of common HDF5 tasks. More details are provided in the following chapters and in the *HDF5 Reference Manual*

2.2.1. Creating an HDF5 File

Before an HDF5 file can be used or referred to in any manner, it must be explicitly created or opened. When the need for access to a file ends, the file must be closed. The example below provides a C code fragment illustrating these steps. In this example, the values for the file creation property list and the file access property list are set to the defaults H5P_DEFAULT.

```
hid_t      file;          /* declare file identifier */
/*
 * Create a new file using H5ACC_TRUNC
 * to truncate and overwrite any file of the same name,
 * default file creation properties, and
 * default file access properties.
 * Then close the file.
 */
file = H5Fcreate(FILE, H5ACC_TRUNC, H5P_DEFAULT, H5P_DEFAULT);
status = H5Fclose(file);
```

Example 1. Creating and closing an HDF5 file

Note: If there is a possibility that a file of the declared name already exists and you wish to open a new file regardless of that possibility, the flag H5ACC_TRUNC will cause the operation to overwrite the previous file. If the operation should fail in such a circumstance, use the flag H5ACC_EXCL instead.

2.2.2. Creating and Initializing a Dataset

The essential objects within a dataset are datatype and dataspace. These are independent objects and are created separately from any dataset to which they may be attached. Hence, creating a dataset requires, at a minimum, the following steps:

1. Create and initialize a dataspace for the dataset
2. Define a datatype for the dataset
3. Create and initialize the dataset

The code in the example below illustrates the execution of these steps.

```

hid_t    dataset, datatype, dataspace; /* declare identifiers */

/*
 * Create a dataspace: Describe the size of the array and
 * create the dataspace for a fixed-size dataset.
 */
dimsf[0] = NX;
dimsf[1] = NY;
dataspace = H5Screate_simple(RANK, dimsf, NULL);
/*
 * Define a datatype for the data in the dataset.
 * We will store little endian integers.
 */
datatype = H5Tcopy(H5T_NATIVE_INT);
status = H5Tset_order(datatype, H5T_ORDER_LE);
/*
 * Create a new dataset within the file using the defined
 * dataspace and datatype and default dataset creation
 * properties.
 * NOTE: H5T_NATIVE_INT can be used as the datatype if
 * conversion to little endian is not needed.
 */
dataset = H5Dcreate(file, DATASETNAME, datatype, dataspace,
                   H5P_DEFAULT, H5P_DEFAULT, H5P_DEFAULT);

```

Example 2. Create a dataset

2.2.3. Closing an Object

An application should close an object such as a datatype, dataspace, or dataset once the object is no longer needed. Since each is an independent object, each must be released (or closed) separately. This action is frequently referred to as releasing the object's identifier. The code in the example below closes the datatype, dataspace, and dataset that were created in the preceding section.

```

H5Tclose(datatype);
H5Dclose(dataset);
H5Sclose(dataspace);

```

Example 3. Close an object

There is a long list of HDF5 Library items that return a unique identifier when the item is created or opened. Each time that one of these items is opened, a unique identifier is returned. Closing a file does not mean that the groups, datasets, or other open items are also closed. Each opened item must be closed separately.

For more information, see [Using Identifiers](#) in the [Additional Resources](#) chapter.

How Closing a File Effects Other Open Structural Elements

Every structural element in an HDF5 file can be opened, and these elements can be opened more than once. Elements range in size from the entire file down to attributes. When an element is opened, the HDF5 Library returns a unique identifier to the application. Every element that is opened must be closed. If an element was

opened more than once, each identifier that was returned to the application must be closed. For example, if a dataset was opened twice, both dataset identifiers must be released (closed) before the dataset can be considered closed. Suppose an application has opened a file, a group in the file, and two datasets in the group. In order for the file to be totally closed, the file, group, and datasets must each be closed. Closing the file before the group or the datasets will not effect the state of the group or datasets: the group and datasets will still be open.

There are several exceptions to the above general rule. One is when the `H5close` function is used. `H5close` causes a general shutdown of the library: all data is written to disk, all identifiers are closed, and all memory used by the library is cleaned up. Another exception occurs on parallel processing systems. Suppose on a parallel system an application has opened a file, a group in the file, and two datasets in the group. If the application uses the `H5Fclose` function to close the file, the call will fail with an error. The open group and datasets must be closed before the file can be closed. A third exception is when the file access property list includes the property `H5F_CLOSE_STRONG`. This property closes any open elements when the file is closed with `H5Fclose`. For more information, see the `H5Pset_fclose_degree` function in the *HDF5 Reference Manual*.

2.2.4. Writing or Reading a Dataset to or from a File

Having created the dataset, the actual data can be written with a call to `H5Dwrite`. See the example below.

```
/*
 * Write the data to the dataset using default transfer
 * properties.
 */
status = H5Dwrite(dataset, H5T_NATIVE_INT, H5S_ALL, H5S_ALL,
                 H5P_DEFAULT, data);
```

Example 4. Writing a dataset

Note that the third and fourth `H5Dwrite` parameters in the above example describe the dataspace in memory and in the file, respectively. For now, these are both set to `H5S_ALL` which indicates that the entire dataset is to be written. The selection of partial datasets and the use of differing dataspace in memory and in storage will be discussed later in this chapter and in more detail elsewhere in this guide.

Reading the dataset from storage is similar to writing the dataset to storage. To read an entire dataset, substitute `H5Dread` for `H5Dwrite` in the above example.

2.2.5. Reading and Writing a Portion of a Dataset

The previous section described writing or reading an entire dataset. HDF5 also supports access to portions of a dataset. These parts of datasets are known as selections.

The simplest type of selection is a simple hyperslab. This is an n-dimensional rectangular sub-set of a dataset where n is equal to the dataset's rank. Other available selections include a more complex hyperslab with user-defined stride and block size, a list of independent points, or the union of any of these.

The figure below shows several sample selections.

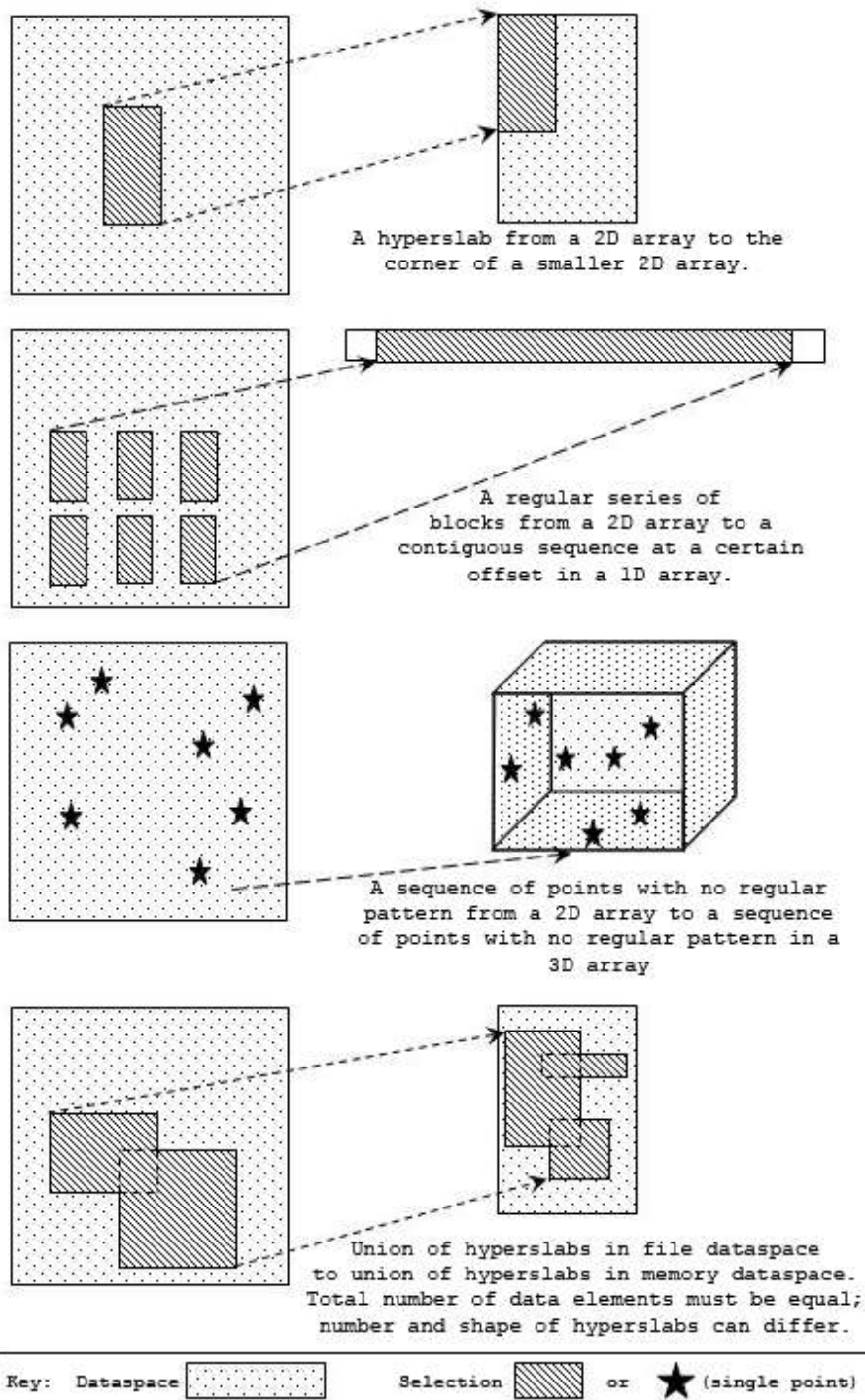

Figure 1. Dataset selections
 Selections can take the form of a simple hyperslab, a hyperslab with user-defined stride and block, a selection of points, or a union of any of these forms.

Selections and hyperslabs are portions of a dataset. As described above, a simple hyperslab is a rectangular array of data elements with the same rank as the dataset's dataspace. Thus, a simple hyperslab is a logically contiguous collection of points within the dataset.

The more general case of a hyperslab can also be a regular pattern of points or blocks within the dataspace. Four parameters are required to describe a general hyperslab: the starting coordinates, the block size, the stride or space between blocks, and the number of blocks. These parameters are each expressed as a one-dimensional array with length equal to the rank of the dataspace and are described in the table below .

Table 2. Hyperslab parameters

Parameter	Definition
start	The coordinates of the starting location of the hyperslab in the dataset's dataspace.
block	The size of each block to be selected from the dataspace. If the block parameter is set to NULL, the block size defaults to a single element in each dimension, as if the block array was set to all 1s (all ones). This will result in the selection of a uniformly spaced set of count points starting at start and on the interval defined by stride.
stride	The number of elements separating the starting point of each element or block to be selected. If the stride parameter is set to NULL, the stride size defaults to 1 (one) in each dimension and no elements are skipped.
count	The number of elements or blocks to select along each dimension.

Reading Data into a Differently Shaped Memory Block

For maximum flexibility in user applications, a selection in storage can be mapped into a differently-shaped selection in memory. All that is required is that the two selections contain the same number of data elements. In this example, we will first define the selection to be read from the dataset in storage, and then we will define the selection as it will appear in application memory.

Suppose we want to read a 3 x 4 hyperslab from a two-dimensional dataset in a file beginning at the dataset element <1,2>. The first task is to create the dataspace that describes the overall rank and dimensions of the dataset in the file and to specify the position and size of the in-file hyperslab that we are extracting from that dataset. See the code below.

```

/*
 * Define dataset dataspace in file.
 */
dataspace = H5Dget_space(dataset); /* dataspace identifier */
rank      = H5Sget_simple_extent_ndims(dataspace);
status_n  = H5Sget_simple_extent_dims(dataspace, dims_out, NULL);

/*
 * Define hyperslab in the dataset.
 */
offset[0] = 1;
offset[1] = 2;
count[0]  = 3;
count[1]  = 4;
status = H5Sselect_hyperslab(dataspace, H5S_SELECT_SET, offset, NULL,
                             count, NULL);

```

Example 5. Define the selection to be read from storage

The next task is to define a dataspace in memory. Suppose that we have in memory a three-dimensional $7 \times 7 \times 3$ array into which we wish to read the two-dimensional 3×4 hyperslab described above and that we want the memory selection to begin at the element $\langle 3,0,0 \rangle$ and reside in the plane of the first two dimensions of the array. Since the in-memory dataspace is three-dimensional, we have to describe the in-memory selection as three-dimensional. Since we are keeping the selection in the plane of the first two dimensions of the in-memory dataset, the in-memory selection will be a $3 \times 4 \times 1$ array defined as $\langle 3,4,1 \rangle$.

Notice that we must describe two things: the dimensions of the in-memory array, and the size and position of the hyperslab that we wish to read in. The code below illustrates how this would be done.

```

/*
 * Define memory dataspace.
 */
dimsm[0] = 7;
dimsm[1] = 7;
dimsm[2] = 3;
memspace = H5Screate_simple(RANK_OUT,dimsm,NULL);

/*
 * Define memory hyperslab.
 */
offset_out[0] = 3;
offset_out[1] = 0;
offset_out[2] = 0;
count_out[0] = 3;
count_out[1] = 4;
count_out[2] = 1;
status = H5Sselect_hyperslab(memspace, H5S_SELECT_SET, offset_out, NULL,
                             count_out, NULL);

```

Example 6. Define the memory dataspace and selection

The hyperslab defined in the code above has the following parameters: $\text{start}=(3,0,0)$, $\text{count}=(3,4,1)$, stride and block size are NULL.

Writing Data into a Differently Shaped Disk Storage Block

Now let's consider the opposite process of writing a selection from memory to a selection in a dataset in a file. Suppose that the source dataspace in memory is a 50-element, one-dimensional array called `vector` and that the source selection is a 48-element simple hyperslab that starts at the second element of `vector`. See the figure below.

-1	1	2	3	...	49	50	-1
----	---	---	---	-----	----	----	----

Figure 2. A one-dimensional array

Further suppose that we wish to write this data to the file as a series of 3 x 2-element blocks in a two-dimensional dataset, skipping one row and one column between blocks. Since the source selection contains 48 data elements and each block in the destination selection contains 6 data elements, we must define the destination selection with 8 blocks. We will write 2 blocks in the first dimension and 4 in the second. The code below shows how to achieve this objective.

```

/* Select the hyperslab for the dataset in the file, using 3 x 2 blocks,
 * a (4,3) stride, a (2,4) count, and starting at the position (0,1).
 */
start[0] = 0; start[1] = 1;
stride[0] = 4; stride[1] = 3;
count[0] = 2; count[1] = 4;
block[0] = 3; block[1] = 2;
ret = H5Sselect_hyperslab(fid, H5S_SELECT_SET, start, stride, count, block);

/*
 * Create dataspace for the first dataset.
 */
mid1 = H5Screate_simple(MSPACE1_RANK, dim1, NULL);

/*
/*
 * Select hyperslab.
 * We will use 48 elements of the vector buffer starting at the second element.
 * Selected elements are 1 2 3 . . . 48
 */
start[0] = 1;
stride[0] = 1;
count[0] = 48;
block[0] = 1;
ret = H5Sselect_hyperslab(mid1, H5S_SELECT_SET, start, stride, count, block);

/*
 * Write selection from the vector buffer to the dataset in the file.
 */
ret = H5Dwrite(dataset, H5T_NATIVE_INT, mid1, fid, H5P_DEFAULT, vector)

```

Example 7. The destination selection

2.2.6. Getting Information about a Dataset

Although reading is analogous to writing, it is often first necessary to query a file to obtain information about the dataset to be read. For instance, we often need to determine the datatype associated with a dataset, or its dataspace (i.e., rank and dimensions). As illustrated in the code example below, there are several get routines for obtaining this information.

```

/*
 * Get datatype and dataspace identifiers,
 * then query datatype class, order, and size, and
 * then query dataspace rank and dimensions.
 */

datatype = H5Dget_type(dataset);      /* datatype identifier */
class    = H5Tget_class(datatype);
if (class == H5T_INTEGER) printf("Dataset has INTEGER type \n");
order    = H5Tget_order(datatype);
if (order == H5T_ORDER_LE) printf("Little endian order \n");

size     = H5Tget_size(datatype);
printf(" Data size is %d \n", size);

dataspace = H5Dget_space(dataset);    /* dataspace identifier */
rank      = H5Sget_simple_extent_ndims(dataspace);
status_n  = H5Sget_simple_extent_dims(dataspace, dims_out);
printf("rank %d, dimensions %d x %d \n", rank, dims_out[0], dims_out[1]);

```

Example 8. Routines to get dataset parameters

2.2.7. Creating and Defining Compound Datatypes

A compound datatype is a collection of one or more data elements. Each element might be an atomic type, a small array, or another compound datatype.

The provision for nested compound datatypes allows these structures to become quite complex. An HDF5 compound datatype has some similarities to a C struct or a Fortran common block. Though not originally designed with databases in mind, HDF5 compound datatypes are sometimes used in a way that is similar to a database record. Compound datatypes can become either a powerful tool or a complex and difficult-to-debug construct. Reasonable caution is advised.

To create and use a compound datatype, you need to create a datatype with class compound (H5T_COMPOUND) and specify the total size of the data element in bytes. A compound datatype consists of zero or more uniquely named members. Members can be defined in any order but must occupy non-overlapping regions within the datum. The table below lists the properties of compound datatype members.

Table 3. Compound datatype member properties

Parameter Definition

Index	An index number between zero and N-1, where N is the number of members in the compound. The elements are indexed in the order of their location in the array of bytes.
Name	A string that must be unique within the members of the same datatype.
Datatype	An HDF5 datatype.
Offset	A fixed byte offset which defines the location of the first byte of that member in the compound datatype.

Properties of the members of a compound datatype are defined when the member is added to the compound type. These properties cannot be modified later.

Defining Compound Datatypes

Compound datatypes must be built out of other datatypes. To do this, you first create an empty compound datatype and specify its total size. Members are then added to the compound datatype in any order.

Each member must have a descriptive name. This is the key used to uniquely identify the member within the compound datatype. A member name in an HDF5 datatype does not necessarily have to be the same as the name of the corresponding member in the C struct in memory although this is often the case. You also do not need to define all the members of the C struct in the HDF5 compound datatype (or vice versa).

Usually a C struct will be defined to hold a data point in memory, and the offsets of the members in memory will be the offsets of the struct members from the beginning of an instance of the struct. The library defines the macro that computes the offset of member *m* within a struct variable *s*:

```
HOFFSET(s, m)
```

The code below shows an example in which a compound datatype is created to describe complex numbers whose type is defined by the `complex_t` struct.

```
typedef struct {
    double re; /*real part */
    double im; /*imaginary part */
} complex_t;

complex_t tmp; /*used only to compute offsets */
hid_t complex_id = H5Tcreate (H5T_COMPOUND, sizeof tmp);
H5Tinsert (complex_id, "real", HOFFSET(tmp,re),
           H5T_NATIVE_DOUBLE);
H5Tinsert (complex_id, "imaginary", HOFFSET(tmp,im),
           H5T_NATIVE_DOUBLE);
```

Example 9. A compound datatype for complex numbers

2.2.8. Creating and Writing Extendable Datasets

An extendable dataset is one whose dimensions can grow. One can define an HDF5 dataset to have certain initial dimensions with the capacity to later increase the size of any of the initial dimensions. For example, the figure below shows a 3 x 3 dataset (a) which is later extended to be a 10 x 3 dataset by adding 7 rows (b), and further extended to be a 10 x 5 dataset by adding two columns (c).

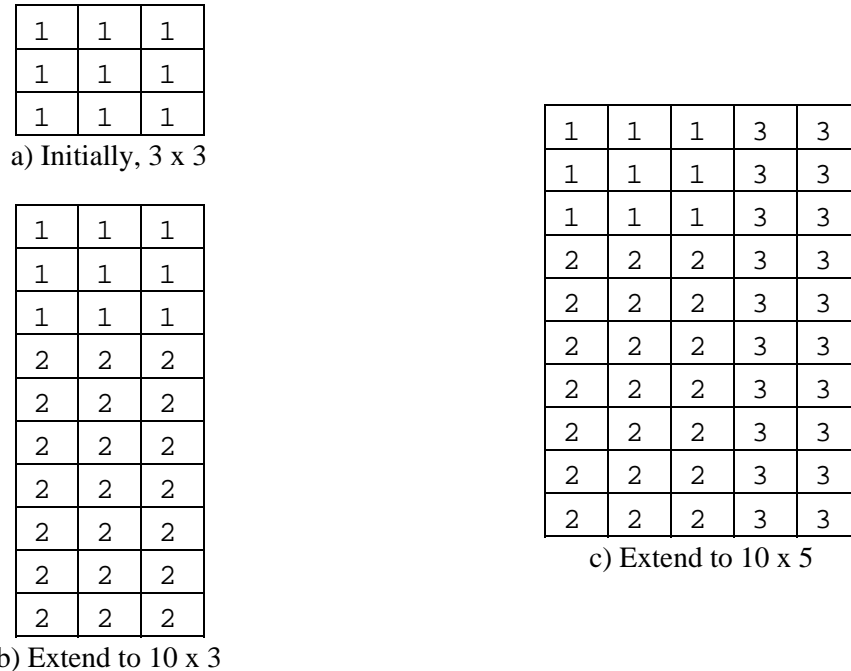

Figure 2. Extending a dataset

HDF5 requires the use of chunking when defining extendable datasets. Chunking makes it possible to extend datasets efficiently without having to reorganize contiguous storage excessively.

To summarize, an extendable dataset requires two conditions:

1. Define the dataspace of the dataset as unlimited in all dimensions that might eventually be extended
2. Enable chunking in the dataset creation properties

For example, suppose we wish to create a dataset similar to the one shown in the figure above. We want to start with a 3 x 3 dataset, and then later we will extend it. To do this, go through the steps below.

First, declare the dataspace to have unlimited dimensions. See the code shown below. Note the use of the predefined constant `H5S_UNLIMITED` to specify that a dimension is unlimited.

```

Hsize_t dims[2] = {3, 3}; /* dataset dimensions
at the creation time */
hsize_t maxdims[2] = {H5S_UNLIMITED, H5S_UNLIMITED};
/*
 * Create the data space with unlimited dimensions.
 */
dataspace = H5Screate_simple(RANK, dims, maxdims);

```

Example 10. Declaring a dataspace with unlimited dimensions

Next, set the dataset creation property list to enable chunking. See the code below.

```
hid_t cparms;
hsize_t chunk_dims[2] = {2, 5};
/*
 * Modify dataset creation properties to enable chunking.
 */
cparms = H5Pcreate (H5P_DATASET_CREATE);
status = H5Pset_chunk(cparms, RANK, chunk_dims);
```

Example 11. Enable chunking

The next step is to create the dataset. See the code below.

```
/*
 * Create a new dataset within the file using cparms
 * creation properties.
 */
dataset = H5Dcreate(file, DATASETNAME, H5T_NATIVE_INT, dataspace,
                   H5P_DEFAULT, cparms, H5P_DEFAULT);
```

Example 12. Create a dataset

Finally, when the time comes to extend the size of the dataset, invoke `H5Dextend`. Extending the dataset along the first dimension by seven rows leaves the dataset with new dimensions of `<10,3>`. See the code below.

```
/*
 * Extend the dataset. Dataset becomes 10 x 3.
 */
dims[0] = dims[0] + 7;
size[0] = dims[0];
size[1] = dims[1];
status = H5Dextend (dataset, size);
```

Example 13. Extend the dataset by seven rows

2.2.9. Creating and Working with Groups

Groups provide a mechanism for organizing meaningful and extendable sets of datasets within an HDF5 file. The H5G API provides several routines for working with groups.

Creating a Group

With no datatype, dataspace, or storage layout to define, creating a group is considerably simpler than creating a dataset. For example, the following code creates a group called `Data` in the root group of `file`.

```
/*
 * Create a group in the file.
 */
grp = H5Gcreate(file, "/Data", H5P_DEFAULT, H5P_DEFAULT, H5P_DEFAULT);
```

Example 14. Create a group

A group may be created within another group by providing the absolute name of the group to the `H5Gcreate` function or by specifying its location. For example, to create the group `Data_new` in the group `Data`, you might use the sequence of calls shown below.

```

/*
 * Create group "Data_new" in the group "Data" by specifying
 * absolute name of the group.
 */
grp_new = H5Gcreate(file, "/Data/Data_new", H5P_DEFAULT, H5P_DEFAULT, H5P_DEFAULT);

or

/*
 * Create group "Data_new" in the "Data" group.
 */
grp_new = H5Gcreate(grp, "Data_new", H5P_DEFAULT, H5P_DEFAULT, H5P_DEFAULT);

```

Example 15. Create a group within a group

This first parameter of `H5Gcreate` is a location identifier. `file` in the first example specifies only the file. `grp` in the second example specifies a particular group in a particular file. Note that in this instance, the group identifier `grp` is used as the first parameter in the `H5Gcreate` call so that the relative name of `Data_new` can be used.

The third parameter of `H5Gcreate` optionally specifies how much file space to reserve to store the names of objects that will be created in this group. If a non-positive value is supplied, the library provides a default size.

Use `H5Gclose` to close the group and release the group identifier.

Creating a Dataset within a Group

As with groups, a dataset can be created in a particular group by specifying either its absolute name in the file or its relative name with respect to that group. The next code excerpt uses the absolute name.

```

/*
 * Create the dataset "Compressed_Data" in the group Data using the
 * absolute name. The dataset creation property list is modified
 * to use GZIP compression with the compression effort set to 6.
 * Note that compression can be used only when the dataset is
 * chunked.
 */
dims[0] = 1000;
dims[1] = 20;
cdims[0] = 20;
cdims[1] = 20;
dataspace = H5Screate_simple(RANK, dims, NULL);
plist      = H5Pcreate(H5P_DATASET_CREATE);
            H5Pset_chunk(plist, 2, cdims);
            H5Pset_deflate(plist, 6);
dataset = H5Dcreate(file, "/Data/Compressed_Data",
                   H5T_NATIVE_INT, dataspace, H5P_DEFAULT, plist, H5P_DEFAULT);

```

Example 16. Create a dataset within a group using an absolute name

Alternatively, you can first obtain an identifier for the group in which the dataset is to be created, and then create the dataset with a relative name.

```

/*
 * Open the group.
 */
grp = H5Gopen(file, "Data", H5P_DEFAULT);

/*
 * Create the dataset "Compressed_Data" in the "Data" group
 * by providing a group identifier and a relative dataset
 * name as parameters to the H5Dcreate function.
 */
dataset = H5Dcreate(grp, "Compressed_Data", H5T_NATIVE_INT,
                   dataspace, H5P_DEFAULT, plist, H5P_DEFAULT);

```

Example 17. Create a dataset within a group using a relative name

Accessing an Object in a Group

Any object in a group can be accessed by its absolute or relative name. The first code snippet below illustrates the use of the absolute name to access the dataset `Compressed_Data` in the group `Data` created in the examples above. The second code snippet illustrates the use of the relative name.

```

/*
 * Open the dataset "Compressed_Data" in the "Data" group.
 */
dataset = H5Dopen(file, "/Data/Compressed_Data", H5P_DEFAULT);

```

Example 18. Accessing a group using its absolute name

```

/*
 * Open the group "data" in the file.
 */
grp = H5Gopen(file, "Data", H5P_DEFAULT);

/*
 * Access the "Compressed_Data" dataset in the group.
 */
dataset = H5Dopen(grp, "Compressed_Data", H5P_DEFAULT);

```

Example 19. Accessing a group using its relative name

2.2.10. Working with Attributes

An attribute is a small dataset that is attached to a normal dataset or group. Attributes share many of the characteristics of datasets, so the programming model for working with attributes is similar in many ways to the model for working with datasets. The primary differences are that an attribute must be attached to a dataset or a group and sub-setting operations cannot be performed on attributes.

To create an attribute belonging to a particular dataset or group, first create a dataspace for the attribute with the call to `H5Screate`, and then create the attribute using `H5Acreate`. For example, the code shown below creates an attribute called `Integer_attribute` that is a member of a dataset whose identifier is `dataset`. The attribute identifier is `attr2`. `H5Awrite` then sets the value of the attribute of that of the integer variable `point`. `H5Aclose` then releases the attribute identifier.

```

Int point = 1;                               /* Value of the scalar attribute */

/*
 * Create scalar attribute.
 */
aid2 = H5Screate(H5S_SCALAR);
attr2 = H5Acreate(dataset, "Integer attribute", H5T_NATIVE_INT, aid2,
                H5P_DEFAULT, H5P_DEFAULT);

/*
 * Write scalar attribute.
 */
ret = H5Awrite(attr2, H5T_NATIVE_INT, &point);

/*
 * Close attribute dataspace.
 */
ret = H5Sclose(aid2);

/*
 * Close attribute.
 */
ret = H5Aclose(attr2);

```

Example 20. Create an attribute

To read a scalar attribute whose name and datatype are known, first open the attribute using `H5Aopen_by_name`, and then use `H5Aread` to get its value. For example, the code shown below reads a scalar attribute called `Integer_attribute` whose datatype is a native integer and whose parent dataset has the identifier `dataset`.

```

/*
 * Attach to the scalar attribute using attribute name, then read and
 * display its value.
 */
attr = H5Aopen_by_name(file_id, dataset_name, "Integer attribute",
                    H5P_DEFAULT, H5P_DEFAULT);
ret = H5Aread(attr, H5T_NATIVE_INT, &point_out);
printf("The value of the attribute \"Integer attribute\" is %d \n", point_out);
ret = H5Aclose(attr);

```

Example 21. Read a known attribute

To read an attribute whose characteristics are not known, go through these steps. First, query the file to obtain information about the attribute such as its name, datatype, rank, and dimensions, and then read the attribute. The following code opens an attribute by its index value using `H5Aopen_by_idx`, and then it reads in information about the datatype with `H5Aread`.

```
/*
 * Attach to the string attribute using its index, then read and display the value.
 */
attr = H5Aopen_by_idx(file_id, dataset_name, index_type, iter_order, 2,
                    H5P_DEFAULT, H5P_DEFAULT);
atype = H5Tcopy(H5T_C_S1);
        H5Tset_size(atype, 4);
ret = H5Aread(attr, atype, string_out);
printf("The value of the attribute with the index 2 is %s \n", string_out);
```

Example 22. Read an unknown attribute

In practice, if the characteristics of attributes are not known, the code involved in accessing and processing the attribute can be quite complex. For this reason, HDF5 includes a function called `H5Aiterate`. This function applies a user-supplied function to each of a set of attributes. The user-supplied function can contain the code that interprets, accesses, and processes each attribute.

2.3. The Data Transfer Pipeline

The HDF5 Library implements data transfers between different storage locations. At the lowest levels, the HDF5 Library reads and writes blocks of bytes to and from storage using calls to the virtual file layer (VFL) drivers. In addition to this, the HDF5 Library manages caches of metadata and a data I/O pipeline. The data I/O pipeline applies compression to data blocks, transforms data elements, and implements selections.

A substantial portion of the HDF5 Library's work is in transferring data from one environment or media to another. This most often involves a transfer between system memory and a storage medium. Data transfers are affected by compression, encryption, machine-dependent differences in numerical representation, and other features. So, the bit-by-bit arrangement of a given dataset is often substantially different in the two environments.

Consider the representation on disk of a compressed and encrypted little-endian array as compared to the same array after it has been read from disk, decrypted, decompressed, and loaded into memory on a big-endian system. HDF5 performs all of the operations necessary to make that transition during the I/O process with many of the operations being handled by the VFL and the data transfer pipeline.

The figure below provides a simplified view of a sample data transfer with four stages. Note that the modules are used only when needed. For example, if the data is not compressed, the compression stage is omitted.

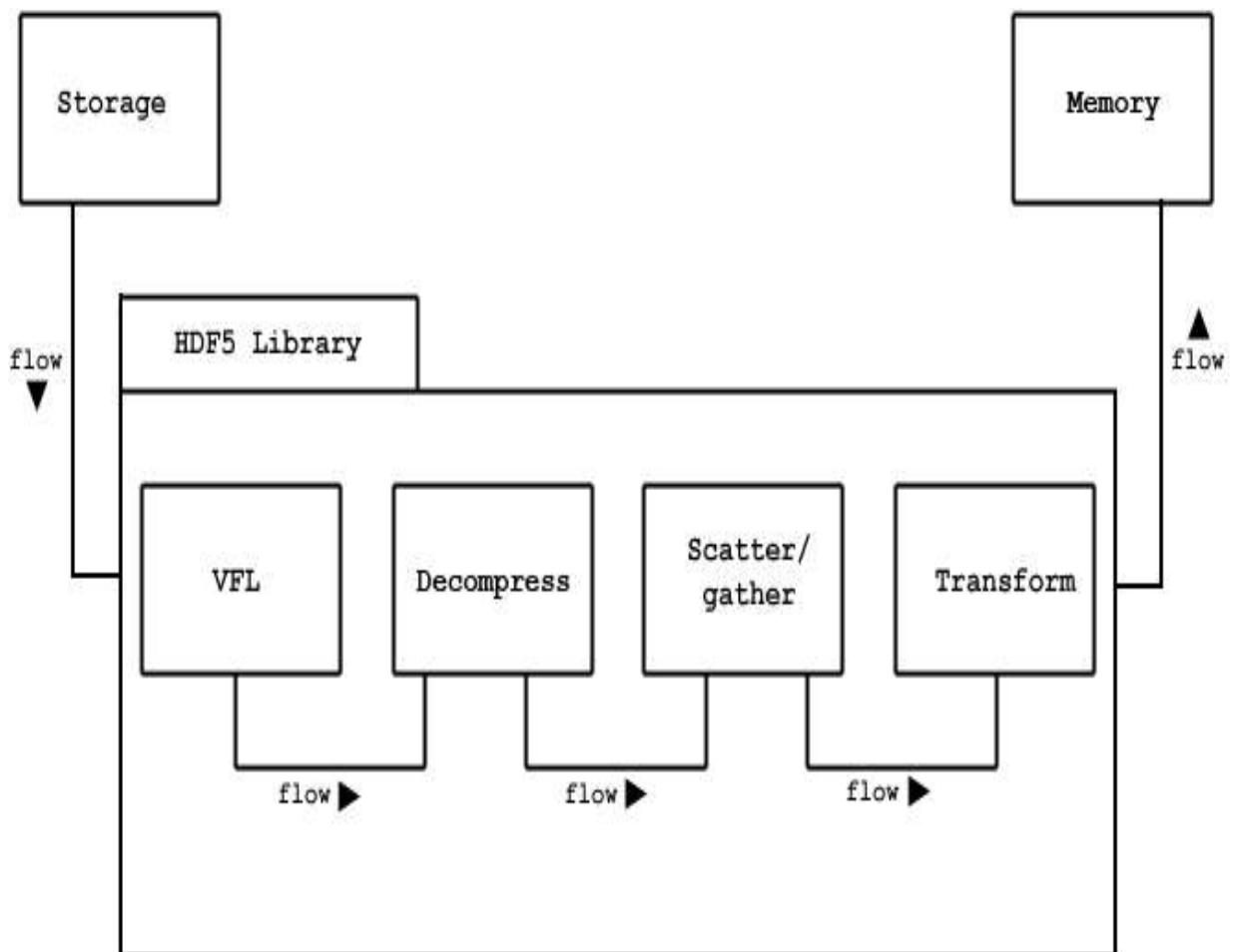

Figure 3. A data transfer from storage to memory

For a given I/O request, different combinations of actions may be performed by the pipeline. The library automatically sets up the pipeline and passes data through the processing steps. For example, for a *read* request (from disk to memory), the library must determine which logical blocks contain the requested data elements and fetch each block into the library's cache. If the data needs to be decompressed, then the compression algorithm is applied to the block after it is read from disk. If the data is a selection, the selected elements are extracted from the data block after it is decompressed. If the data needs to be transformed (for example, byte swapped), then the data elements are transformed after decompression and selection.

While an application must sometimes set up some elements of the pipeline, use of the pipeline is normally transparent to the user program. The library determines what must be done based on the metadata for the file, the object, and the specific request. An example of when an application might be required to set up some elements in the pipeline is if the application used a custom error-checking algorithm.

In some cases, it is necessary to pass parameters to and from modules in the pipeline or among other parts of the library that are not directly called through the programming API. This is accomplished through the use of dataset transfer and data access property lists.

The VFL provides an interface whereby user applications can add custom modules to the data transfer pipeline. For example, a custom compression algorithm can be used with the HDF5 Library by linking an appropriate module into the pipeline through the VFL. This requires creating an appropriate wrapper for the compression module and registering it with the library with `H5Zregister`. The algorithm can then be applied to a dataset with an `H5Pset_filter` call which will add the algorithm to the selected dataset's transfer property list.

Part II

The Specifics

Chapter 3

The HDF5 File

3.1. Introduction

The purpose of this chapter is to describe how to work with HDF5 data files.

If HDF5 data is to be written to or read from a file, the file must first be explicitly created or opened with the appropriate file driver and access privileges. Once all work with the file is complete, the file must be explicitly closed.

This chapter discusses the following:

- File access modes
- Creating, opening, and closing files
- The use of file creation property lists
- The use of file access property lists
- The use of low-level file drivers

This chapter assumes an understanding of the material presented in the data model chapter, “HDF5 Data Model and File Structure.”

3.1.1. File Access Modes

There are two issues regarding file access:

- What should happen when a new file is created but a file of the same name already exists? Should the create action fail, or should the existing file be overwritten?
- Is a file to be opened with read-only or read-write access?

Four access modes address these concerns. Two of these modes can be used with `H5Fcreate`, and two modes can be used with `H5Fopen`.

- `H5Fcreate` accepts `H5F_ACC_EXCL` or `H5F_ACC_TRUNC`
- `H5Fopen` accepts `H5F_ACC_RDONLY` or `H5F_ACC_RDWR`

The access modes are described in the table below.

Table 1. Access flags and modes

Access Flag	Resulting Access Mode
H5F_ACC_EXCL	If the file already exists, H5Fcreate fails. If the file does not exist, it is created and opened with read-write access. (Default)
H5F_ACC_TRUNC	If the file already exists, the file is opened with read-write access, and new data will overwrite any existing data. If the file does not exist, it is created and opened with read-write access.
H5F_ACC_RDONLY	An existing file is opened with read-only access. If the file does not exist, H5Fopen fails. (Default)
H5F_ACC_RDWR	An existing file is opened with read-write access. If the file does not exist, H5Fopen fails.

By default, H5Fopen opens a file for read-only access; passing H5F_ACC_RDWR allows read-write access to the file.

By default, H5Fcreate fails if the file already exists; only passing H5F_ACC_TRUNC allows the truncating of an existing file.

3.1.2. File Creation and File Access Properties

File creation and file access property lists control the more complex aspects of creating and accessing files.

File creation property lists control the characteristics of a file such as the size of the user-block, a user-definable data block; the size of data address parameters; properties of the B-trees that are used to manage the data in the file; and certain HDF5 library versioning information.

See the “File Creation Properties,” section below, for a more detailed discussion of file creation properties and appropriate references to the *HDF5 Reference Manual*. If you have no special requirements for these file characteristics, you can simply specify H5P_DEFAULT for the default file creation property list when a file creation property list is called for.

File access property lists control properties and means of accessing a file such as data alignment characteristics, metadata block and cache sizes, data sieve buffer size, garbage collection settings, and parallel I/O. Data alignment, metadata block and cache sizes, and data sieve buffer size are factors in improving I/O performance.

See the “File Access Properties” section below for a more detailed discussion of file access properties and appropriate references to the *HDF5 Reference Manual*. If you have no special requirements for these file access characteristics, you can simply specify H5P_DEFAULT for the default file access property list when a file access property list is called for.

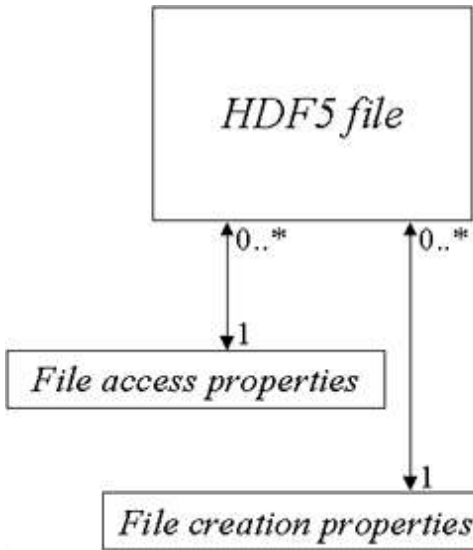

Figure 1. UML model for an HDF5 file and its property lists

3.1.3. Low-level File Drivers

The concept of an HDF5 file is actually rather abstract: the address space for what is normally thought of as an HDF5 file might correspond to any of the following at the storage level:

- Single file on a standard file system
- Multiple files on a standard file system
- Multiple files on a parallel file system
- Block of memory within an application's memory space
- More abstract situations such as virtual files

This HDF5 address space is generally referred to as an *HDF5 file* regardless of its organization at the storage level.

HDF5 accesses a file (the address space) through various types of *low-level file drivers*. The default HDF5 file storage layout is as an unbuffered permanent file which is a single, contiguous file on local disk. Alternative layouts are designed to suit the needs of a variety of systems, environments, and applications.

3.2. Programming Model

Programming models for creating, opening, and closing HDF5 files are described in the sub-sections below.

3.2.1. Creating a New File

The programming model for creating a new HDF5 file can be summarized as follows:

- Define the file creation property list
- Define the file access property list
- Create the file

First, consider the simple case where we use the default values for the property lists. See the example below.

```
file_id = H5Fcreate ("SampleFile.h5", H5F_ACC_EXCL,
                   H5P_DEFAULT, H5P_DEFAULT)
```

Example 1. Creating an HDF5 file using property list defaults

Note that this example specifies that `H5Fcreate` should fail if `SampleFile.h5` already exists.

A more complex case is shown in the example below. In this example, we define file creation and access property lists (though we do not assign any properties), specify that `H5Fcreate` should fail if `SampleFile.h5` already exists, and create a new file named `SampleFile.h5`. The example does not specify a driver, so the default driver, `SEC2` or `H5FD_SEC2`, will be used.

```
fcplist_id = H5Pcreate (H5P_FILE_CREATE)
<...set desired file creation properties...>
faplist_id = H5Pcreate (H5P_FILE_ACCESS)
<...set desired file access properties...>
file_id = H5Fcreate ("SampleFile.h5", H5F_ACC_EXCL, fcplist_id, faplist_id)
```

Example 2. Creating an HDF5 file using property lists

Notes:

A root group is automatically created in a file when the file is first created.

File property lists, once defined, can be reused when another file is created within the same application.

3.2.2. Opening an Existing File

The programming model for opening an existing HDF5 file can be summarized as follows:

- Define or modify the file access property list including a low-level file driver (optional)
- Open the file

The code in the example below shows how to open an existing file with read-only access.

```
faplist_id = H5Pcreate (H5P_FILE_ACCESS)
status = H5Pset_fapl_stdio (faplist_id)
file_id = H5Fopen ("SampleFile.h5", H5F_ACC_RDONLY, faplist_id)
```

Example 3. Opening an HDF5 file

3.2.3. Closing a File

The programming model for closing an HDF5 file is very simple:

- Close file

We close `SampleFile.h5` with the code in the example below.

```
status = H5Fclose (file_id)
```

Example 4. Closing an HDF5 file

Note that `H5Fclose` flushes all unwritten data to storage and that `file_id` is the identifier returned for `SampleFile.h5` by `H5Fopen`.

More comprehensive discussions regarding all of these steps are provided below.

3.3. Using h5dump to View a File

h5dump is a command-line utility that is included in the HDF5 distribution. This program provides a straight-forward means of inspecting the contents of an HDF5 file. You can use h5dump to verify that a program is generating the intended HDF5 file. h5dump displays ASCII output formatted according to the HDF5 DDL grammar.

The following h5dump command will display the contents of `SampleFile.h5`:

```
h5dump SampleFile.h5
```

If no datasets or groups have been created in and no data has been written to the file, the output will look something like the following:

```
HDF5 "SampleFile.h5" {  
  GROUP "/" {  
  }  
}
```

Note that the root group, indicated above by `/`, was automatically created when the file was created.

h5dump is fully described on the Tools page of the *HDF5 Reference Manual*. The HDF5 DDL grammar is fully described in the document DDL in BNF for HDF5, an element of this *HDF5 User's Guide*.

3.4. File Function Summaries

General library functions and macros (H5), file functions (H5F), file related property list functions (H5P), and file driver functions (H5P) are listed below.

Function Listing 1. General library functions and macros (H5)

C Function	Purpose
Fortran Function	
H5check_version	Verifies that HDF5 library versions are consistent.
h5check_version_f	
H5close	Flushes all data to disk, closes all open identifiers, and cleans up memory.
h5close_f	
H5dont_atexit	Instructs the library not to install the <code>atexit</code> cleanup routine.
h5dont_atexit_f	
H5garbage_collect	Garbage collects on all free-lists of all types.
h5garbage_collect_f	
H5get_libversion	Returns the HDF library release number.
h5get_libversion_f	
H5open	Initializes the HDF5 library.
h5open_f	
H5set_free_list_limits	Sets free-list size limits.
h5set_free_list_limits_f	
H5_VERSION_GE (none)	Determines whether the version of the library being used is greater than or equal to the specified version.
H5_VERSION_LE (none)	Determines whether the version of the library being used is less than or equal to the specified version.

Function Listing 2. File functions (H5F)

C Function	Purpose
Fortran Function	
H5Fclear_elink_file_cache (none)	Clears the external link open file cache for a file.
H5Fclose h5fclose_f	Closes HDF5 file.
H5Fcreate h5fcreate_f	Creates new HDF5 file.
H5Fflush h5fflush_f	Flushes data to HDF5 file on storage medium.
H5Fget_access_plist h5fget_access_plist_f	Returns a file access property list identifier.
H5Fget_create_plist h5fget_create_plist_f	Returns a file creation property list identifier.
H5Fget_filesize h5fget_filesize_f	Returns the size of an HDF5 file.
H5Fget_freespace h5fget_freespace_f	Returns the amount of free space in a file.
H5Fget_info (none)	Returns global information for a file.
H5Fget_intent (none)	Determines the read/write or read-only status of a file.
H5Fget_mdc_config (none)	Obtain current metadata cache configuration for target file.
H5Fget_mdc_hit_rate (none)	Obtain target file's metadata cache hit rate.
H5Fget_mdc_size (none)	Obtain current metadata cache size data for specified file.
H5Fget_name h5fget_name_f	Retrieves name of file to which object belongs.
H5Fget_obj_count h5fget_obj_count_f	Returns the number of open object identifiers for an open file.
H5Fget_obj_ids h5fget_obj_ids_f	Returns a list of open object identifiers.
H5Fget_vfd_handle (none)	Returns pointer to the file handle from the virtual file driver.
H5Fis_hdf5 h5fis_hdf5_f	Determines whether a file is in the HDF5 format.
H5Fmount h5fmount_f	Mounts a file.
H5Fopen h5fopen_f	Opens existing HDF5 file.

H5Freopen	Returns a new identifier for a previously-opened HDF5 file.
h5freopen_f	
H5Freset_mdc_hit_rate_stats	Reset hit rate statistics counters for the target file.
(none)	
H5Fset_mdc_config	Use to configure metadata cache of target file.
(none)	
H5Funmount	Unmounts a file.
h5funmount_f	

Function Listing 3. File creation property list functions (H5P)

C Function	Purpose
Fortran Function	
H5Pset/get_userblock	Sets/retrieves size of user-block.
h5pset/get_userblock_f	
H5Pset/get_sizes	Sets/retrieves byte size of offsets and lengths used to address objects in HDF5 file.
h5pset/get_sizes_f	
H5Pset/get_sym_k	Sets/retrieves size of parameters used to control symbol table nodes.
h5pset/get_sym_k_f	
H5Pset/get_istore_k	Sets/retrieves size of parameter used to control B-trees for indexing chunked datasets.
h5pset/get_istore_k_f	
H5Pset_shared_mesg_nindexes	Sets number of shared object header message indexes.
h5pset_shared_mesg_nindexes_f	
H5Pget_shared_mesg_nindexes	Retrieves number of shared object header message indexes in file creation property list.
(none)	
H5Pset_shared_mesg_index	Configures the specified shared object header message index.
h5pset_shared_mesg_index_f	
H5Pget_shared_mesg_index	Retrieves the configuration settings for a shared message index.
(none)	
H5Pset_shared_mesg_phase_change	Sets shared object header message storage phase change thresholds.
(none)	
H5Pget_shared_mesg_phase_change	Retrieves shared object header message phase change information.
(none)	
H5Pget_version	Retrieves version information for various objects for file creation property list.
h5pget_version_f	

Function Listing 4. File access property list functions (H5P)

C Function	Purpose
Fortran Function	
H5Pset/get_alignment h5pset/get_alignment_f	Sets/retrieves alignment properties.
H5Pset/get_cache h5pset/get_cache_f	Sets/retrieves metadata cache and raw data chunk cache parameters.
H5Pset/get_extern_file_cache_size (none)	Sets/retrieves the size of the external link open file cache from the specified file access property list.
H5Pset/get_fclose_degree h5pset/get_fclose_degree_f	Sets/retrieves file close degree property.
H5Pset/get_gc_references h5pset/get_gc_references_f	Sets/retrieves garbage collecting references flag.
H5Pset_family_offset h5pset_family_offset_f	Sets offset property for low-level access to a file in a family of files.
H5Pget_family_offset (none)	Retrieves a data offset from the file access property list.
H5Pset/get_meta_block_size h5pset/get_meta_block_size_f	Sets the minimum metadata block size or retrieves the current metadata block size setting.
H5Pset_mdc_config (none)	Set the initial metadata cache configuration in the indicated File Access Property List to the supplied value.
H5Pget_mdc_config (none)	Get the current initial metadata cache configuration from the indicated File Access Property List.
H5Pset/get_sieve_buf_size h5pset/get_sieve_buf_size_f	Sets/retrieves maximum size of data sieve buffer.
H5Pset_libver_bounds h5pset_libver_bounds_f	Sets bounds on library versions, and indirectly format versions, to be used when creating objects.
H5Pget_libver_bounds (none)	Retrieves library version bounds settings that indirectly control the format versions used when creating objects.
H5Pset_small_data_block_size h5pset_small_data_block_size_f	Sets the size of a contiguous block reserved for small data.
H5Pget_small_data_block_size h5pget_small_data_block_size_f	Retrieves the current small data block size setting.

Function Listing 5. File driver functions (H5P)

C Function	Purpose
Fortran Function	
H5Pset_driver (none)	Sets a file driver.
H5Pget_driver h5pget_driver_f	Returns the identifier for the driver used to create a file.
H5Pget_driver_info (none)	Returns a pointer to file driver information.
H5Pset/get_fapl_core h5pset/get_fapl_core_f	Sets driver for buffered memory files (i.e., in RAM) or retrieves information regarding driver.
H5Pset_fapl_direct h5pset_fapl_direct_f	Sets up use of the direct I/O driver.
H5Pget_fapl_direct h5pget_fapl_direct_f	Retrieves direct I/O driver settings.
H5Pset/get_fapl_family h5pset/get_fapl_family_f	Sets driver for file families, designed for systems that do not support files larger than 2 gigabytes, or retrieves information regarding driver.
H5Pset_fapl_log (none)	Sets logging driver.
H5Pset/get_fapl_mpio h5pset/get_fapl_mpio_f	Sets driver for files on parallel file systems (MPI I/O) or retrieves information regarding the driver.
H5Pset_fapl_mpio h5pset_fapl_mpio_f	Stores MPI IO communicator information to a file access property list.
H5Pget_fapl_mpio h5pget_fapl_mpio_f	Returns MPI communicator information.
H5Pset/get_fapl_multi h5pset/get_fapl_multi_f	Sets driver for multiple files, separating categories of metadata and raw data, or retrieves information regarding driver.
H5Pset_fapl_sec2 h5pset_fapl_sec2_f	Sets driver for unbuffered permanent files or retrieves information regarding driver.
H5Pset_fapl_split h5pset_fapl_split_f	Sets driver for split files, a limited case of multiple files with one metadata file and one raw data file.
H5Pset_fapl_stdio H5Pset_fapl_stdio_f	Sets driver for buffered permanent files.
H5Pset_fapl_windows (none)	Sets the Windows I/O driver.
H5Pset_multi_type (none)	Specifies type of data to be accessed via the MULTI driver enabling more direct access.
H5Pget_multi_type (none)	Retrieves type of data property for MULTI driver.

3.5. Creating or Opening an HDF5 File

This section describes in more detail how to create and how to open files.

New HDF5 files are created and opened with `H5Fcreate`; existing files are opened with `H5Fopen`. Both functions return an object identifier which must eventually be released by calling `H5Fclose`.

To create a new file, call `H5Fcreate`:

```
hid_t H5Fcreate (const char *name, unsigned flags,
               hid_t fcpl_id, hid_t fapl_id)
```

`H5Fcreate` creates a new file named *name* in the current directory. The file is opened with read and write access; if the `H5F_ACC_TRUNC` flag is set, any pre-existing file of the same name in the same directory is truncated. If `H5F_ACC_TRUNC` is not set or `H5F_ACC_EXCL` is set and if a file of the same name exists, `H5Fcreate` will fail.

The new file is created with the properties specified in the property lists *fcpl_id* and *fapl_id*. *fcpl* is short for file creation property list. *fapl* is short for file access property list. Specifying `H5P_DEFAULT` for either the creation or access property list calls for the library's default creation or access properties. See "File Property Lists" below for details on setting property list values. See "File Access Modes" above for the list of file access flags and their descriptions.

If `H5Fcreate` successfully creates the file, it returns a file identifier for the new file. This identifier will be used by the application any time an object identifier, an OID, for the file is required. Once the application has finished working with a file, the identifier should be released and the file closed with `H5Fclose`.

To open an existing file, call `H5Fopen`:

```
hid_t H5Fopen (const char *name, unsigned flags, hid_t fapl_id)
```

`H5Fopen` opens an existing file with read-write access if `H5F_ACC_RDWR` is set and read-only access if `H5F_ACC_RDONLY` is set.

fapl_id is the file access property list identifier. Alternatively, `H5P_DEFAULT` indicates that the application relies on the default I/O access parameters. Creating and changing access property lists is documented further below.

A file can be opened more than once via multiple `H5Fopen` calls. Each such call returns a unique file identifier and the file can be accessed through any of these file identifiers as long as they remain valid. Each of these file identifiers must be released by calling `H5Fclose` when it is no longer needed.

3.6. Closing an HDF5 File

`H5Fclose` both closes a file and releases the file identifier returned by `H5Fopen` or `H5Fcreate`. `H5Fclose` must be called when an application is done working with a file; while the HDF5 Library makes every effort to maintain file integrity, failure to call `H5Fclose` may result in the file being abandoned in an incomplete or corrupted state.

To close a file, call `H5Fclose`:

```
herr_t H5Fclose (hid_t file_id)
```

This function releases resources associated with an open file. After closing a file, the file identifier, `file_id`, cannot be used again as it will be undefined.

`H5Fclose` fulfills three purposes: to ensure that the file is left in an uncorrupted state, to ensure that all data has been written to the file, and to release resources. Use `H5Fflush` if you wish to ensure that all data has been written to the file but it is premature to close it.

Note regarding serial mode behavior: When `H5Fclose` is called in serial mode, it closes the file and terminates new access to it, but it does not terminate access to objects that remain individually open within the file. That is, if `H5Fclose` is called for a file but one or more objects within the file remain open, those objects will remain accessible until they are individually closed. To illustrate, assume that a file, `fileA`, contains a dataset, `data_setA`, and that both are open when `H5Fclose` is called for `fileA`. `data_setA` will remain open and accessible, including writable, until it is explicitly closed. The file will be automatically and finally closed once all objects within it have been closed.

Note regarding parallel mode behavior: Once `H5Fclose` has been called in parallel mode, access is no longer available to any object within the file.

3.7. File Property Lists

Additional information regarding file structure and access are passed to `H5Fcreate` and `H5Fopen` through property list objects. Property lists provide a portable and extensible method of modifying file properties via simple API functions. There are two kinds of file-related property lists:

- File creation property lists
- File access property lists

In the following sub-sections, we discuss only one file creation property, user-block size, in detail as a model for the user. Other file creation and file access properties are mentioned and defined briefly, but the model is not expanded for each; complete syntax, parameter, and usage information for every property list function is provided in the “H5P: Property List Interface” chapter of the *HDF5 Reference Manual*.

3.7.1. Creating a Property List

If you do not wish to rely on the default file creation and access properties, you must first create a property list with `H5Pcreate`.

```
hid_t H5Pcreate (hid_t cls_id)
```

type is the type of property list being created. In this case, the appropriate values are `H5P_FILE_CREATE` for a file creation property list and `H5P_FILE_ACCESS` for a file access property list.

Thus, the following calls create a file creation property list and a file access property list with identifiers *fcpl_id* and *facpl_id*, respectively:

```
fcpl_id = H5Pcreate (H5P_FILE_CREATE)
facpl_id = H5Pcreate (H5P_FILE_ACCESS)
```

Once the property lists have been created, the properties themselves can be modified via the functions described in the following sub-sections.

3.7.2. File Creation Properties

File creation property lists control the file metadata, which is maintained in the superblock of the file. These properties are used only when a file is first created.

User-block size

```
herr_t H5Pset_userblock (hid_t plist, hsize_t size)
herr_t H5Pget_userblock (hid_t plist, hsize_t *size)
```

The *user-block* is a fixed-length block of data located at the beginning of the file and is ignored by the HDF5 Library. This block is specifically set aside for any data or information that developers determine to be useful to their applications but that will not be used by the HDF5 Library. The *size* of the user-block is defined in bytes and may be set to any power of two with a minimum size of 512 bytes. In other words, user-blocks might be 512, 1024, or 2048 bytes in size.

This property is set with `H5Pset_userblock` and queried via `H5Pget_userblock`. For example, if an application needed a 4K user-block, then the following function call could be used:

```
status = H5Pset_userblock(fcpl_id, 4096)
```

The property list could later be queried with

```
status = H5Pget_userblock(fcpl_id, size)
```

and the value 4096 would be returned in the parameter *size*.

Other properties, described below, are set and queried in exactly the same manner. Syntax and usage are detailed in the “H5P: Property List Interface” section of the *HDF5 Reference Manual*.

Offset and length sizes

This property specifies the number of bytes used to store the offset and length of objects in the HDF5 file. Values of 2, 4, and 8 bytes are currently supported to accommodate 16-bit, 32-bit, and 64-bit file address spaces.

These properties are set and queried via `H5Pset_sizes` and `H5Pget_sizes`.

Symbol table parameters

The size of symbol table B-trees can be controlled by setting the 1/2-rank and 1/2-node size parameters of the B-tree.

These properties are set and queried via `H5Pset_sym_k` and `H5Pget_sym_k`.

Indexed storage parameters

The size of indexed storage B-trees can be controlled by setting the 1/2-rank and 1/2-node size parameters of the B-tree.

These properties are set and queried via `H5Pset_istore_k` and `H5Pget_istore_k`.

Version information

Various objects in an HDF5 file may over time appear in different versions. The HDF5 Library keeps track of the version of each object in the file.

Version information is retrieved via `H5Pget_version`.

3.7.3. File Access Properties

This section discusses file access properties that are not related to the low-level file drivers. File drivers are discussed separately in “Alternate File Storage Layouts and Low-level File Drivers,” later in this chapter.

File access property lists control various aspects of file I/O and structure.

Data alignment

Sometimes file access is faster if certain data elements are aligned in a specific manner. This can be controlled by setting alignment properties via the `H5Pset_alignment` function. There are two values involved:

- ◊ A threshold value
- ◊ An alignment interval

Any allocation request at least as large as the threshold will be aligned on an address that is a multiple of the alignment interval.

Metadata block allocation size

Metadata typically exists as very small chunks of data; storing metadata elements in a file without blocking them can result in hundreds or thousands of very small data elements in the file. This can result in a highly fragmented file and seriously impede I/O. By blocking metadata elements, these small elements can be grouped in larger sets, thus alleviating both problems.

`H5Pset_meta_block_size` sets the minimum size in bytes of metadata block allocations.

`H5Pget_meta_block_size` retrieves the current minimum metadata block allocation size.

Metadata cache

Metadata and raw data I/O speed are often governed by the size and frequency of disk reads and writes. In many cases, the speed can be substantially improved by the use of an appropriate cache.

`H5Pset_cache` sets the minimum cache size for both metadata and raw data and a preemption value for raw data chunks. `H5Pget_cache` retrieves the current values.

Data sieve buffer size

Data sieve buffering is used by certain file drivers to speed data I/O and is most commonly when working with dataset hyperslabs. For example, using a buffer large enough to hold several pieces of a dataset as it is read in for hyperslab selections will boost performance noticeably.

`H5Pset_sieve_buf_size` sets the maximum size in bytes of the data sieve buffer.

`H5Pget_sieve_buf_size` retrieves the current maximum size of the data sieve buffer.

Garbage collection references

Dataset region references and other reference types use space in an HDF5 file’s global heap. If garbage collection is on (1) and the user passes in an uninitialized value in a reference structure, the heap might become corrupted. When garbage collection is off (0), however, and the user re-uses a reference, the previous heap block will be orphaned and not returned to the free heap space. When garbage collection is on, the user must initialize the reference structures to 0 or risk heap corruption.

`H5Pset_gc_references` sets the garbage collecting references flag.

3.8. Alternate File Storage Layouts and Low-level File Drivers

The concept of an HDF5 file is actually rather abstract: the address space for what is normally thought of as an HDF5 file might correspond to any of the following:

- Single file on standard file system
- Multiple files on standard file system
- Multiple files on parallel file system
- Block of memory within application's memory space
- More abstract situations such as virtual files

This HDF5 address space is generally referred to as an *HDF5 file* regardless of its organization at the storage level.

HDF5 employs an extremely flexible mechanism called the *virtual file layer*, or VFL, for file I/O. A full understanding of the VFL is only necessary if you plan to write your own drivers (see “Virtual File Layer” and “List of VFL Functions” in the *HDF5 Technical Notes*). For our purposes here, it is sufficient to know that the low-level drivers used for file I/O reside in the VFL, as illustrated in the following figure.

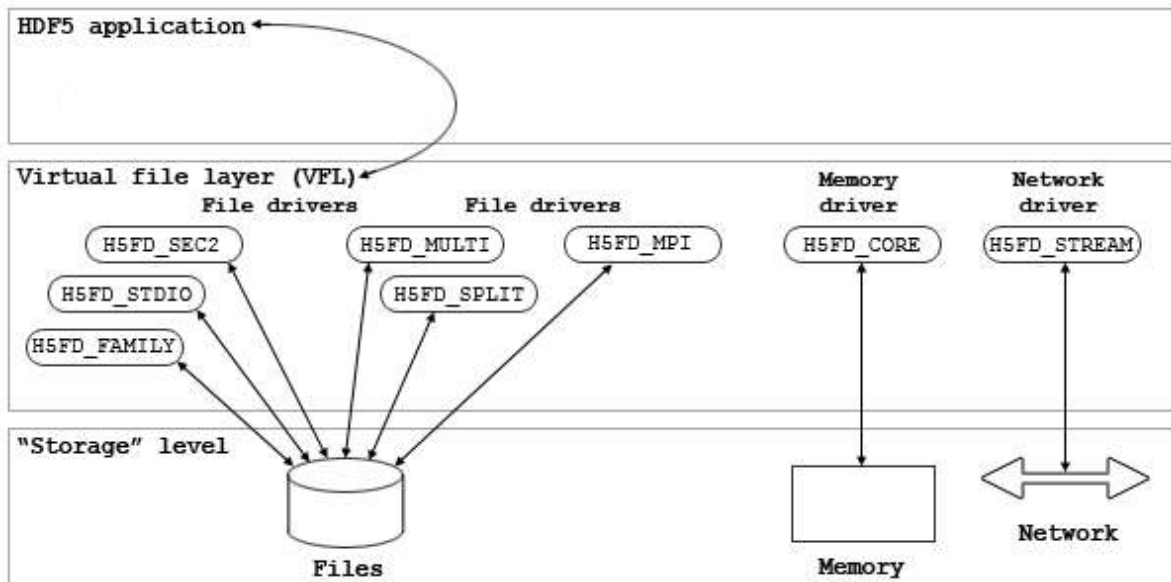

Figure 2. I/O path from application through VFL and low-level drivers to storage level

As mentioned above, HDF5 applications access HDF5 files through various *low-level file drivers*. The default HDF5 file storage layout is as an unbuffered permanent file which is a single, contiguous file on local disk. The default driver for that layout is the SEC2 driver, H5FD_SEC2. Alternative layouts and drivers are designed to suit the needs of a variety of systems, environments, and applications.

The following table lists the supported drivers distributed with the HDF5 Library and their associated file storage layouts.

Table 2. Supported file drivers

Storage Layout	Driver	Intended Usage
Unbuffered permanent file	H5FD_SEC2	Permanent file on local disk with minimal buffering. Posix-compliant. Default.
Buffered permanent file	H5FD_STDIO	Permanent file on local disk with additional low-level buffering.
File family	H5FD_FAMILY	Several files that, together, constitute a single virtual HDF5 file. Designed for systems that do not support files larger than 2 gigabytes.
Multiple files	H5FD_MULTI	Separate files for different types of metadata and for raw data.
Split files	H5FD_SPLIT	Two files, one for metadata and one for raw data (limited case of H5FD_MULTI).
Parallel files (MPI I/O)	H5FD_MPI	Parallel files accessed via the MPI I/O layer. The standard HDF5 file driver for parallel file systems.
Buffered temporary file	H5FD_CORE	Temporary file maintained in memory, not written to disk.
Access logs	H5FD_LOG	The SEC2 driver with logging capabilities.

Note that the low-level file drivers manage alternative file storage layouts. Dataset storage layouts (chunking, compression, and external dataset storage) are managed independently of file storage layouts.

If an application requires a special-purpose low-level driver, the VFL provides a public API for creating one. For more information on how to create a driver, see “Virtual File Layer” and “List of VFL Functions” in the *HDF5 Technical Notes*.

3.8.1. Identifying the Previously-used File Driver

When creating a new HDF5 file, no history exists, so the file driver must be specified if it is to be other than the default.

When opening existing files, however, the application may need to determine which low-level driver was used to create the file. The function `H5Pget_driver` is used for this purpose. See the example below.

```
hid_t H5Pget_driver (hid_t fapl_id)
```

Example 5. Identifying a driver

`H5Pget_driver` returns a constant identifying the low-level driver for the access property list *fapl_id*. For example, if the file was created with the SEC2 driver, `H5Pget_driver` returns `H5FD_SEC2`.

If the application opens an HDF5 file without both determining the driver used to create the file and setting up the use of that driver, the HDF5 Library will examine the superblock and the driver definition block to identify the driver. See the *HDF5 File Format Specification* for detailed descriptions of the superblock and the driver definition block.

3.8.2. Unbuffered Permanent Files - SEC2 driver

The SEC2 driver, `H5FD_SEC2`, uses functions from section 2 of the Posix manual to access unbuffered files stored on a local file system. The HDF5 Library buffers metadata regardless of the low-level driver, but using this driver prevents data from being buffered again by the lowest layers of the library.

The function `H5Pset_fapl_sec2` sets the file access properties to use the SEC2 driver. See the example below.

```
herr_t H5Pset_fapl_sec2 (hid_t fapl_id)
```

Example 6. Using the SEC2 driver

Any previously-defined driver properties are erased from the property list.

Additional parameters may be added to this function in the future. Since there are no additional variable settings associated with the SEC2 driver, there is no `H5Pget_fapl_sec2` function.

3.8.3. Buffered Permanent Files - STDIO driver

The STDIO driver, `H5FD_STDIO` also accesses permanent files in a local file system, but with an additional layer of buffering beneath the HDF5 Library.

The function `H5Pset_fapl_stdio` sets the file access properties to use the STDIO driver. See the example below.

```
herr_t H5Pset_fapl_stdio (hid_t fapl_id)
```

Example 7. Using the STDIO driver

Any previously defined driver properties are erased from the property list.

Additional parameters may be added to this function in the future. Since there are no additional variable settings associated with the STDIO driver, there is no `H5Pget_fapl_stdio` function.

3.8.4. File families -- FAMILY driver

HDF5 files can become quite large, and this can create problems on systems that do not support files larger than 2 gigabytes. The HDF5 file family mechanism is designed to solve the problems this creates by splitting the HDF5 file address space across several smaller files. This structure does not affect how metadata and raw data are stored: they are mixed in the address space just as they would be in a single, contiguous file.

HDF5 applications access a family of files via the FAMILY driver, `H5FD_FAMILY`. The functions `H5Pset_fapl_family` and `H5Pget_fapl_family` are used to manage file family properties. See the example below.

```
herr_t H5Pset_fapl_family (hid_t fapl_id, hsize_t memb_size,
                          hid_t member_properties)

herr_t H5Pget_fapl_family (hid_t fapl_id, hsize_t *memb_size,
                          hid_t *member_properties)
```

Example 8. Managing file family properties

Each member of the family is the same logical size though the size and disk storage reported by file system listing tools may be substantially smaller. Examples of file system listing tools are `'ls -l'` on a UNIX system or the detailed folder listing on an Apple Macintosh or Microsoft Windows system. The name passed to `H5Fcreate` or `H5Fopen` should include a `printf(3c)`-style integer format specifier which will be replaced with the family member number. The first family member is numbered zero (0).

`H5Pset_fapl_family` sets the access properties to use the `FAMILY` driver; any previously defined driver properties are erased from the property list. *member_properties* will serve as the file access property list for each member of the file family. *memb_size* specifies the logical size, in bytes, of each family member. *memb_size* is used only when creating a new file or truncating an existing file; otherwise the member size is determined by the size of the first member of the family being opened. Note: If the size of the `off_t` type is four bytes, the maximum family member size is usually $2^{31}-1$ because the byte at offset 2,147,483,647 is generally inaccessible.

`H5Pget_fapl_family` is used to retrieve file family properties. If the file access property list is set to use the `FAMILY` driver, *member_properties* will be returned with a pointer to a copy of the appropriate member access property list. If *memb_size* is non-null, it will contain the logical size, in bytes, of family members.

Additional parameters may be added to these functions in the future.

UNIX Tools and an HDF5 Utility

It occasionally becomes necessary to repartition a file family. A command-line utility for this purpose, `h5repart`, is distributed with the HDF5 Library.

```
h5repart [-v] [-b block_size[suffix]] [-m member_size[suffix]] source destination
```

`h5repart` repartitions an HDF5 file by copying the source file or file family to the destination file or file family, preserving holes in the underlying UNIX files. Families are used for the source and/or destination if the name includes a `printf`-style integer format such as `%d`. The `-v` switch prints input and output file names on the standard error stream for progress monitoring, `-b` sets the I/O block size (the default is 1kB), and `-m` sets the output member size if the destination is a family name (the default is 1GB). *block_size* and *member_size* may be suffixed with the letters `g`, `m`, or `k` for GB, MB, or kB respectively.

The `h5repart` utility is fully described on the Tools page of the *HDF5 Reference Manual*.

An existing HDF5 file can be split into a family of files by running the file through `split(1)` on a UNIX system and numbering the output files. However, the HDF5 Library is lazy about extending the size of family members, so a valid file cannot generally be created by concatenation of the family members.

Splitting the file and rejoining the segments by concatenation (`split(1)` and `cat(1)` on UNIX systems) does not generate files with holes; holes are preserved only through the use of `h5repart`.

3.8.5. Multiple Metadata and Raw Data Files - MULTI driver

In some circumstances, it is useful to separate metadata from raw data and some types of metadata from other types of metadata. Situations that would benefit from use of the MULTI driver include the following:

- In networked situations where the small metadata files can be kept on local disks but larger raw data files must be stored on remote media
- In cases where the raw data is extremely large
- In situations requiring frequent access to metadata held in RAM while the raw data can be efficiently held on disk

In either case, access to the metadata is substantially easier with the smaller, and possibly more localized, metadata files. This often results in improved application performance.

The MULTI driver, `H5FD_MULTI`, provides a mechanism for segregating raw data and different types of metadata into multiple files. The functions `H5Pset_fapl_multi` and `H5Pget_fapl_multi` are used to manage access properties for these multiple files. See the example below.

```
herr_t H5Pset_fapl_multi (hid_t fapl_id, const H5FD_mem_t *memb_map,
                        const hid_t *memb_fapl, const char * const *memb_name,
                        const haddr_t *memb_addr, hbool_t relax)
herr_t H5Pget_fapl_multi (hid_t fapl_id, const H5FD_mem_t *memb_map,
                        const hid_t *memb_fapl, const char **memb_name,
                        const haddr_t *memb_addr, hbool_t *relax)
```

Example 9. Managing access properties for multiple files

`H5Pset_fapl_multi` sets the file access properties to use the MULTI driver; any previously defined driver properties are erased from the property list. With the MULTI driver invoked, the application will provide a base name to `H5Fopen` or `H5Fcreate`. The files will be named by that base name as modified by the rule indicated in `memb_name`. File access will be governed by the file access property list `memb_properties`.

See `H5Pset_fapl_multi` and `H5Pget_fapl_multi` in the *HDF5 Reference Manual* for descriptions of these functions and their usage.

Additional parameters may be added to these functions in the future.

3.8.6. Split Metadata and Raw Data Files - SPLIT driver

The SPLIT driver, `H5FD_SPLIT`, is a limited case of the MULTI driver where only two files are created. One file holds metadata, and the other file holds raw data.

The function `H5Pset_fapl_split` is used to manage SPLIT file access properties. See the example below.

```
herr_t H5Pset_fapl_split (hid_t access_properties,
                        const char *meta_extension, hid_t meta_properties,
                        const char *raw_extension, hid_t raw_properties)
```

Example 10. Managing access properties for split files

`H5Pset_fapl_split` sets the file access properties to use the SPLIT driver; any previously defined driver properties are erased from the property list.

With the SPLIT driver invoked, the application will provide a base file name such as *file_name* to `H5Fcreate` or `H5Fopen`. The metadata and raw data files in storage will then be named *file_name.meta_extension* and *file_name.raw_extension*, respectively. For example, if *meta_extension* is defined as `.meta` and *raw_extension* is defined as `.raw`, the final filenames will be *file_name.meta* and *file_name.raw*.

Each file can have its own file access property list. This allows the creative use of other low-level file drivers. For instance, the metadata file can be held in RAM and accessed via the CORE driver while the raw data file is stored on disk and accessed via the SEC2 driver. Metadata file access will be governed by the file access property list in *meta_properties*. Raw data file access will be governed by the file access property list in *raw_properties*.

Additional parameters may be added to these functions in the future. Since there are no additional variable settings associated with the SPLIT driver, there is no `H5Pget_fapl_split` function.

3.8.7. Parallel I/O with MPI I/O - MPI driver

Most of the low-level file drivers described here are for use with serial applications on serial systems.

Parallel environments, on the other hand, require a parallel low-level driver. HDF5 relies on MPI I/O in parallel environments and the MPI driver, `H5FD_MPI`, for parallel file access.

The functions `H5Pset_fapl_mpio` and `H5Pget_fapl_mpio` are used to manage parallel file access properties. See the example below.

```
herr_t H5Pset_fapl_mpio (hid_t fapl_id, MPI_Comm comm,
                       MPI_info info)
herr_t H5Pget_fapl_mpio (hid_t fapl_id, MPI_Comm *comm,
                       MPI_info *info)
```

Example 11. Managing parallel file access properties

The file access properties managed by `H5Pset_fapl_mpio` and retrieved by `H5Pget_fapl_mpio` are the MPI communicator, *comm*, and the MPI info object, *info*. *comm* and *info* are used for file open. *info* is an information object much like an HDF5 property list. Both are defined in `MPI_FILE_OPEN` of MPI-2.

The communicator and the info object are saved in the file access property list *fapl_id*. *fapl_id* can then be passed to `MPI_FILE_OPEN` to create and/or open the file.

This function does not create duplicate *comm* or *info* objects. Any modification to either object after this function call returns may have an undetermined effect on the access property list; users should not modify either of the *comm* or *info* objects while they are defined in a property list.

`H5Pset_fapl_mpio` and `H5Pget_fapl_mpio` are available only in the parallel HDF5 Library and are not collective functions. The MPI driver is available only in the parallel HDF5 Library.

Additional parameters may be added to these functions in the future.

3.8.8. Buffered Temporary Files in Memory - CORE driver

There are several situations in which it is reasonable, sometimes even required, to maintain a file entirely in system memory. You might want to do so if, for example, either of the following conditions apply:

- Performance requirements are so stringent that disk latency is a limiting factor
- You are working with small, temporary files that will not be retained and, thus, need not be written to storage media

The CORE driver, `H5FD_CORE`, provides a mechanism for creating and managing such in-memory files. The functions `H5Pset_fapl_core` and `H5Pget_fapl_core` manage CORE file access properties. See the example below.

```
herr_t H5Pset_fapl_core (hid_t access_properties,
                       size_t block_size, hbool_t backing_store)
herr_t H5Pget_fapl_core (hid_t access_properties,
                       size_t *block_size), hbool_t *backing_store)
```

Example 12. Managing file access for in-memory files

`H5Pset_fapl_core` sets the file access property list to use the CORE driver; any previously defined driver properties are erased from the property list.

Memory for the file will always be allocated in units of the specified `block_size`.

While using `H5Fcreate` to create a CORE file, `backing_store` is a boolean flag indicating whether to write the file contents to disk when the file is closed. If `backing_store` is set to 1 (TRUE), the file contents are flushed to a file with the same name as the CORE file when the file is closed or access to the file is terminated in memory. If `backing_store` is set to 0 (FALSE), the file is not saved.

The application is allowed to open an existing file with the `H5FD_CORE` driver. While using `H5Fopen` to open an existing file, if `backing_store` is set to 1 and the `flag` for `H5Fopen` is set to `H5F_ACC_RDWR`, changes to the file contents will be saved to the file when the file is closed. If `backing_store` is set to 0 and the `flag` for `H5Fopen` is set to `H5F_ACC_RDWR`, changes to the file contents will be lost when the file is closed. If the `flag` for `H5Fopen` is set to `H5F_ACC_RDONLY`, no change to the file will be allowed either in memory or on file.

If the file access property list is set to use the CORE driver, `H5Pget_fapl_core` will return `block_size` and `backing_store` with the relevant file access property settings.

Note the following important points regarding in-memory files:

- Local temporary files are created and accessed directly from memory without ever being written to disk
- Total file size must not exceed the available virtual memory
- Only one HDF5 file identifier can be opened for the file, the identifier returned by `H5Fcreate` or `H5Fopen`
- The changes to the file will be discarded when access is terminated unless `backing_store` is set to 1

Additional parameters may be added to these functions in the future.

3.8.9. Access Logging - LOG driver

The LOG driver, H5FD_LOG, is designed for situations where it is necessary to log file access activity.

The function H5Pset_fapl_log is used to manage logging properties. See the example below.

```
herr_t H5Pset_fapl_log (hid_t fapl_id, const char *logfile,
                      unsigned int flags, size_t buf_size)
```

Example 13. Logging file access

H5Pset_fapl_log sets the file access property list to use the LOG driver. File access characteristics are identical to access via the SEC2 driver. Any previously defined driver properties are erased from the property list.

Log records are written to the file *logfile*.

The logging levels set with the *verbosity* parameter are shown in the table below.

Table 3. Logging levels

Level	Comments
0	Performs no logging.
1	Records where writes and reads occur in the file.
2	Records where writes and reads occur in the file and what kind of data is written at each location. This includes raw data or any of several types of metadata (object headers, superblock, B-tree data, local headers, or global headers).

There is no H5Pget_fapl_log function.

Additional parameters may be added to this function in the future.

3.9. Code Examples for Opening and Closing Files

3.9.1. Example Using the H5F_ACC_TRUNC Flag

The following example uses the H5F_ACC_TRUNC flag when it creates a new file. The default file creation and file access properties are also used. Using H5F_ACC_TRUNC means the function will look for an existing file with the name specified by the function. In this case, that name is FILE. If the function does not find an existing file, it will create one. If it does find an existing file, it will empty the file in preparation for a new set of data. The identifier for the "new" file will be passed back to the application program. See the "File Access Modes" section for more information.

```

hid_t file;                                /* identifier */

/* Create a new file using H5F_ACC_TRUNC access, default file
 * creation properties, and default file access properties. */
file = H5Fcreate(FILE, H5F_ACC_TRUNC, H5P_DEFAULT, H5P_DEFAULT);

/* Close the file. */
status = H5Fclose(file);

```

Example 14. Creating a file with default creation and access properties

3.9.2. Example with the File Creation Property List

The example below shows how to create a file with 64-bit object offsets and lengths.

```

hid_t create_plist;
hid_t file_id;
create_plist = H5Pcreate(H5P_FILE_CREATE);
H5Pset_sizes(create_plist, 8, 8);
file_id = H5Fcreate("test.h5", H5F_ACC_TRUNC,
                  create_plist, H5P_DEFAULT);
.
.
.
H5Fclose(file_id);

```

Example 15. Creating a file with 64-bit offsets

3.9.3. Example with File Access Property List

This example shows how to open an existing file for independent datasets access by MPI parallel I/O:

```
hid_t access_plist;
hid_t file_id;
access_plist = H5Pcreate(H5P_FILE_ACCESS);
H5Pset_fapl_mpi(access_plist, MPI_COMM_WORLD, MPI_INFO_NULL);

/* H5Fopen must be called collectively */
file_id = H5Fopen("test.h5", H5F_ACC_RDWR, access_plist);
.
.
.
/* H5Fclose must be called collectively */
H5Fclose(file_id);
```

Example 16. Opening an existing file for parallel I/O

Chapter 4

HDF5 Groups

4.1. Introduction

As suggested by the name Hierarchical Data Format, an HDF5 file is hierarchically structured. The HDF5 group and link objects implement this hierarchy.

In the simple and most common case, the file structure is a tree structure; in the general case, the file structure may be a directed graph with a designated entry point. The tree structure is very similar to the file system structures employed on UNIX systems, directories and files, and on Apple Macintosh and Microsoft Windows systems, folders and files. HDF5 groups are analogous to the directories and folders; HDF5 datasets are analogous to the files.

The one very important difference between the HDF5 file structure and the above-mentioned file system analogs is that HDF5 groups are linked as a directed graph, allowing circular references; the file systems are strictly hierarchical, allowing no circular references. The figures below illustrate the range of possibilities.

In Figure 1, the group structure is strictly hierarchical, identical to the file system analogs.

In Figures 2 and 3, the structure takes advantage of the directed graph's allowance of circular references. In Figure 2, GroupA is not only a member of the root group, /, but a member of GroupC. Since Group C is a member of Group B and Group B is a member of Group A, Dataset1 can be accessed by means of the circular reference /Group A/Group B/Group C/Group A/Dataset1. Figure 3 illustrates an extreme case in which GroupB is a member of itself, enabling a reference to a member dataset such as /Group A/Group B/Group B/Group B/Dataset2.

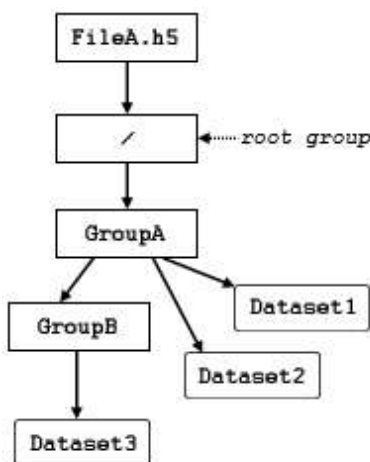

Figure 1. An HDF5 file with a strictly hierarchical group structure

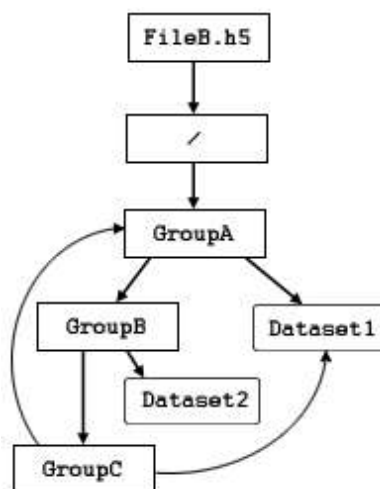

Figure 2. An HDF5 file with a directed graph group structure including a circular reference

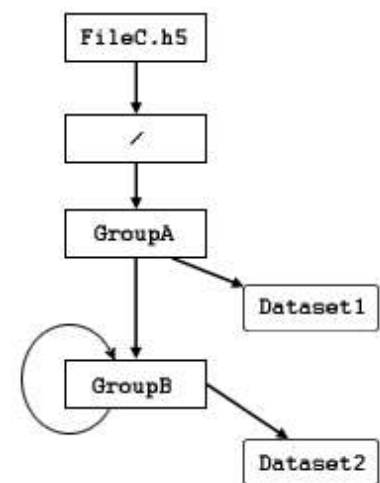

Figure 3. An HDF5 file with a directed graph group structure and one group as a member of itself

As becomes apparent upon reflection, directed graph structures can become quite complex; caution is advised!

The balance of this chapter discusses the following topics:

- The HDF5 group object (or a group) and its structure in more detail
- HDF5 link objects (or links)
- The programming model for working with groups and links
- HDF5 functions provided for working with groups, group members, and links
- Retrieving information about objects in a group
- Discovery of the structure of an HDF5 file and the contained objects
- Examples of file structures

4.2. Description of the Group Object

4.2.1 The Group Object

Abstractly, an HDF5 group contains zero or more objects and every object must be a member of at least one group. The root group, the sole exception, may not belong to any group.

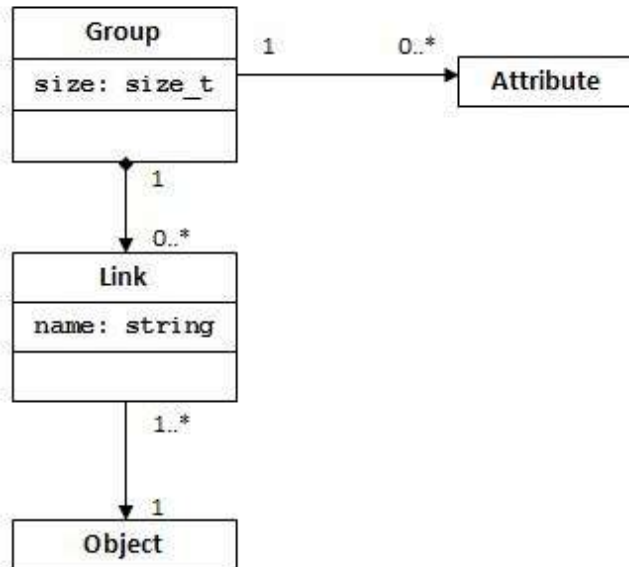

Figure 4. Abstract model of the HDF5 group object

Group membership is actually implemented via *link* objects. See the figure above. A link object is owned by a group and points to a *named object*. Each link has a *name*, and each link points to exactly one object. Each named object has at least one and possibly many links to it.

There are three classes of named objects: *group*, *dataset*, and *named datatype*. See the figure below. Each of these objects is the member of at least one group, which means there is at least one link to it.

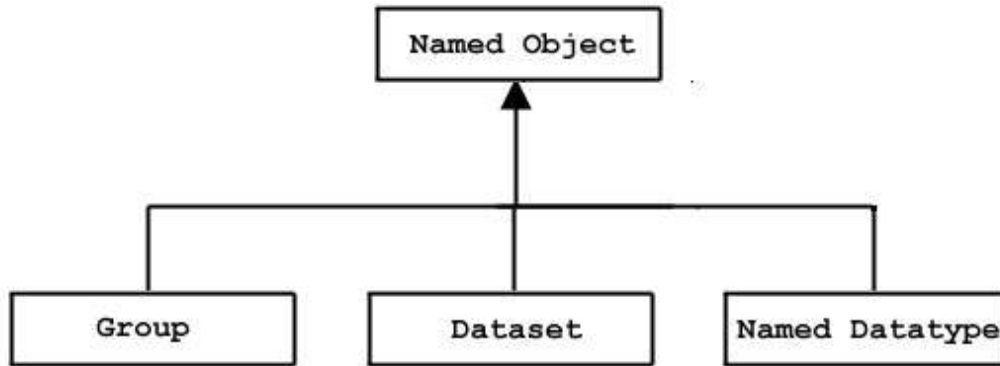

Figure 5. Classes of named objects

The primary operations on a group are to add and remove members and to discover member objects. These abstract operations, as listed in the figure below, are implemented in the H5G APIs, as listed in section 4, “Group Function Summaries.”

To add and delete members of a group, links from the group to *existing* objects in the file are created and deleted with the *link* and *unlink* operations. When a *new* named object is created, the HDF5 Library executes the link operation in the background immediately after creating the object (i.e., a new object is added as a member of the group in which it is created without further user intervention).

Given the name of an object, the *get_object_info* method retrieves a description of the object, including the number of references to it. The *iterate* method iterates through the members of the group, returning the name and type of each object.

Group
size:size_t
create() open() close()
link() unlink() move()
iterate() get_object_info() get_link_info()

Figure 6. The group object

Every HDF5 file has a single root group, with the name `/`. The root group is identical to any other HDF5 group,

except:

- The root group is automatically created when the HDF5 file is created (`H5Fcreate`).
- The root group has no parent, but, by convention has a reference count of 1.
- The root group cannot be deleted (i.e., unlinked)!

4.2.2 The Hierarchy of Data Objects

An HDF5 file is organized as a rooted, directed graph using HDF5 group objects. The named data objects are the nodes of the graph, and the links are the directed arcs. Each arc of the graph has a name, with the special name `/` reserved for the root group. New objects are created and then inserted into the graph with a link operation that is automatically executed by the library; existing objects are inserted into the graph with a link operation explicitly called by the user, which creates a named link from a group to the object.

An object can be the target of more than one link.

The names on the links must be unique within each group, but there may be many links with the same name in different groups. These are unambiguous, because some ancestor must have a different name, or else they are the same object. The graph is navigated with path names, analogous to Unix file systems (see section 2.3, “HDF5 Path Names”). An object can be opened with a full path starting at the root group, or with a relative path and a starting point. That starting point is always a group, though it may be the current working group, another specified group, or the root group of the file. Note that all paths are relative to a single HDF5 file. In this sense, an HDF5 file is analogous to a single UNIX file system.¹

It is important to note that, just like the UNIX file system, HDF5 objects do not have *names*, the names are associated with *paths*. An object has an *object identifier* that is unique within the file, but a single object may have many *names* because there may be many paths to the same object. An object can be renamed, or moved to another group, by adding and deleting links. In this case, the object itself never moves. For that matter, membership in a group has no implication for the physical location of the stored object.

Deleting a link to an object does not necessarily delete the object. The object remains available as long as there is at least one link to it. After all links to an object are deleted, it can no longer be opened, and the storage may be reclaimed.

It is also important to realize that the linking mechanism can be used to construct very complex graphs of objects. For example, it is possible for object to be shared between several groups and even to have more than one name in the same group. It is also possible for a group to be a member of itself, or to create other *cycles* in the graph, such as in the case where a child group is linked to one of its ancestors.

HDF5 also has *soft links* similar to UNIX soft links. A *soft link* is an object that has a name and a path name for the target object. The soft link can be followed to open the target of the link just like a regular or *hard* link. The differences are that the hard link cannot be created if the target object does not exist and it always points to the same object. A soft link can be created with any path name, whether or not the object exists; it may or may not, therefore, be possible to follow a soft link. Furthermore, a soft link's target object may be changed.

4.2.3 HDF5 Path Names

The structure of the HDF5 file constitutes the name space for the objects in the file. A path name is a string of components separated by slashes (/). Each component is the name of a hard or soft link which points to an object in the file. The slash not only separates the components, but indicates their hierarchical relationship; the component indicated by the link name following a slash is always a member of the component indicated by the link name preceding that slash.

The first component in the path name may be any of the following:

- the special character dot (.), a period), indicating the current group
- the special character slash (/), indicating the root group
- any member of the current group

Component link names may be any string of ASCII characters not containing a slash or a dot (/ and ., which are reserved as noted above). However, users are advised to avoid the use of punctuation and non-printing characters, as they may create problems for other software. The figure below provides a BNF grammar for HDF5 path names.

```

PathName ::= AbsolutePathName | RelativePathName
Separator ::= "/" ["/"]*
AbsolutePathName ::= Separator [ RelativePathName ]
RelativePathName ::= Component [ Separator RelativePathName ]*
Component ::= "." | Characters
Characters ::= Character+ - { "." }
Character ::= {c: c ∈ { { legal ASCII characters } - {'/' } }

```

Figure 7. A BNF grammar for HDF5 path names

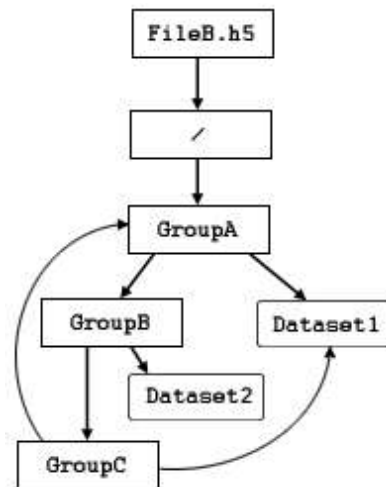

Figure 8. An HDF5 file with a directed graph group structure, including a circular reference

An object can always be addressed by either a *full or absolute* path name, starting at the root group, or by a *relative* path name, starting in a known location such as the current working group. As noted elsewhere, a given object may have multiple full and relative path names.

Consider, for example, the file illustrated in the figure below. `Dataset1` can be identified by either of these absolute path names:

```
/GroupA/Dataset1
/GroupA/GroupB/GroupC/Dataset1
```

Since an HDF5 file is a directed graph structure, and is therefore not limited to a strict tree structure, and since this illustrated file includes the sort of circular reference that a directed graph enables, `Dataset1` can also be identified by this absolute path name:

```
/GroupA/GroupB/GroupC/GroupA/Dataset1
```

Alternatively, if the current working location is `GroupB`, `Dataset1` can be identified by either of these relative path names:

```
GroupC/Dataset1
GroupC/GroupA/Dataset1
```

Note that relative path names in HDF5 do not employ the `../` notation, the UNIX notation indicating a parent directory, to indicate a parent group.

4.2.4 Group Implementations in HDF5

The original HDF5 group implementation provided a single indexed structure for link storage. A new group implementation, in HDF5 Release 1.8.0, enables more efficient compact storage for very small groups, improved link indexing for large groups, and other advanced features.

- The *original indexed* format remains the default. Links are stored in a B-tree in the group's local heap.
- Groups created in the new *compact-or-indexed* format, the implementation introduced with Release 1.8.0, can be tuned for performance, switching between the compact and indexed formats at thresholds set in the user application.
 - ◆ The *compact* format will conserve file space and processing overhead when working with small groups and is particularly valuable when a group contains no links. Links are stored as a list of messages in the group's header.
 - ◆ The *indexed* format will yield improved performance when working with large groups, e.g., groups containing thousands to millions of members. Links are stored in a fractal heap and indexed with an improved B-tree.
- The new implementation also enables the use of link names consisting of non-ASCII character sets (see `H5Pset_char_encoding`) and is required for all link types other than hard or soft links, e.g., external and user-defined links (see the H5L APIs).

The original group structure and the newer structures are not directly interoperable. By default, a group will be created in the original indexed format. An existing group can be changed to a compact-or-indexed format if the need arises; there is no capability to change back. As stated above, once in the compact-or-indexed format, a group can switch between compact and indexed as needed.

Groups will be initially created in the compact-or-indexed format only when one or more of the following conditions is met:

- The *low version bound* value of the *library version bounds* property has been set to Release 1.8.0 or later in the file access property list (see `H5Pset_libver_bounds`). Currently, that would require an `H5Pset_libver_bounds` call with the *low* parameter set to `H5F_LIBVER_LATEST`.

When this property is set for an HDF5 file, all objects in the file will be created using the latest available format; no effort will be made to create a file that can be read by older libraries.

- The creation order tracking property, `H5P_CRT_ORDER_TRACKED`, has been set in the group creation property list (see `H5Pset_link_creation_order`).

An existing group, currently in the original indexed format, will be converted to the compact-or-indexed format upon the occurrence of any of the following events:

- An external or user-defined link is inserted into the group.
- A link named with a string composed of non-ASCII characters is inserted into the group.

The compact-or-indexed format offers performance improvements that will be most notable at the extremes, i.e., in groups with zero members and in groups with tens of thousands of members. But measurable differences may sometimes appear at a threshold as low as eight group members. Since these performance thresholds and criteria differ from application to application, tunable settings are provided to govern the switch between the compact and indexed formats (see `H5Pset_link_phase_change`). Optimal thresholds will depend on the application and the operating environment.

Future versions of HDF5 will retain the ability to create, read, write, and manipulate all groups stored in either the original indexed format or the compact-or-indexed format.

4.3. Using h5dump

You can use `h5dump`, the command-line utility distributed with HDF5, to examine a file for purposes either of determining where to create an object within an HDF5 file or to verify that you have created an object in the intended place. inspecting the contents of an HDF5 file.

In the case of the new group created in section 5.1, “Creating a group,” the following `h5dump` command will display the contents of `FileA.h5`:

```
h5dump FileA.h5
```

Assuming that the discussed objects, `GroupA` and `GroupB` are the only objects that exist in `FileA.h5`, the output will look something like the following:

```
HDF5 "FileA.h5" {  
  GROUP "/" {  
    GROUP GroupA {  
    GROUP GroupB {  
    }  
  }  
}
```

`h5dump` is fully described on the Tools page of the *HDF5 Reference Manual*.

The HDF5 DDL grammar is fully described in the document DDL in BNF for HDF5, an element of this *HDF5 User's Guide*.

4.4. Group Function Summaries

Functions that can be used with groups (H5G functions) and property list functions that can be used with groups (H5P functions) are listed below. A number of group functions have been deprecated. Most of these have become link (H5L) or object (H5O) functions. These replacement functions are also listed below.

Function Listing 1. Group functions (H5G)

C Function	Purpose
Fortran Function	
H5Gcreate h5gcreate_f	Creates a new empty group and gives it a name. The C function is a macro: see “API Compatibility Macros in HDF5.”
H5Gcreate_anon h5gcreate_anon_f	Creates a new empty group without linking it into the file structure.
H5Gopen h5gopen_f	Opens an existing group for modification and returns a group identifier for that group. The C function is a macro: see “API Compatibility Macros in HDF5.”
H5Gclose h5gclose_f	Closes the specified group.
H5Gget_create_plist h5gget_create_plist_f	Gets a group creation property list identifier.
H5Gget_info h5gget_info_f	Retrieves information about a group. Use instead of H5Gget_num_objs.
H5Gget_info_by_idx h5gget_info_by_idx_f	Retrieves information about a group according to the group's position within an index.
H5Gget_info_by_name h5gget_info_by_name_f	Retrieves information about a group.
(none) h5gget_obj_info_idx_f	Returns name and type of the group member identified by its index. Use with the h5gn_members_f function. h5gget_obj_info_idx_f and h5gn_members_f are the Fortran equivalent of the C function H5Literate.
(none) h5gn_members_f	Returns the number of group members. Use with the h5gget_obj_info_idx_f function.

Function Listing 2. Link (H5L) and object (H5O) functions

C Function	Purpose
Fortran Function	
H5Lcreate_hard h5lcreate_hard_f	Creates a hard link to an object. Replaces H5Glink and H5Glink2.
H5Lcreate_soft h5lcreate_soft_f	Creates a soft link to an object. Replaces H5Glink and H5Glink2.
H5Lcreate_external h5lcreate_external_f	Creates a soft link to an object in a different file. Replaces H5Glink and H5Glink2.
H5Lcreate_ud (none)	Creates a link of a user-defined type.
H5Lget_val (none)	Returns the value of a symbolic link. Replaces H5Gget_linkval.
H5Literate (none)	Iterates through links in a group. Replaces H5Giterate. See also H5Ovisit and H5Lvisit.
H5Lget_info h5lget_info_f	Returns information about a link. Replaces H5Gget_objinfo.
H5Oget_info (none)	Retrieves the metadata for an object specified by an identifier. Replaces H5Gget_objinfo.
H5Lget_name_by_idx h5lget_name_by_idx_f	Retrieves name of the nth link in a group, according to the order within a specified field or index. Replaces H5Gget_objname_by_idx.
H5Oget_info_by_idx (none)	Retrieves the metadata for an object, identifying the object by an index position. Replaces H5Gget_objtype_by_idx.
H5Oset_comment (none)	Sets the comment for specified object. Replaces H5Gset_comment.
H5Oget_comment (none)	Gets the comment for specified object. Replaces H5Gget_comment.
H5Ldelete h5ldelete_f	Removes a link from a group. Replaces H5Gunlink.
H5Lmove h5lmove_f	Renames a link within an HDF5 file. Replaces H5Gmove and H5Gmove2.

Function Listing 3. Group creation property list functions (H5P)

C Function	Purpose
Fortran Function	
H5Pall_filters_avail (none)	Verifies that all required filters are available.
H5Pget_filter h5pget_filter_f	Returns information about a filter in a pipeline. The C function is a macro: see “API Compatibility Macros in HDF5.”
H5Pget_filter_by_id h5pget_filter_by_id_f	Returns information about the specified filter. The C function is a macro: see “API Compatibility Macros in HDF5.”
H5Pget_nfilters h5pget_nfilters_f	Returns the number of filters in the pipeline.
H5Pmodify_filter h5pmodify_filter_f	Modifies a filter in the filter pipeline.
H5Premove_filter h5premove_filter_f	Deletes one or more filters in the filter pipeline.
H5Pset_deflate h5pset_deflate_f	Sets the deflate (GNU gzip) compression method and compression level.
H5Pset_filter h5pset_filter_f	Adds a filter to the filter pipeline.
H5Pset_fletcher32 h5pset_fletcher32_f	Sets up use of the Fletcher32 checksum filter.
H5Pset_fletcher32 h5pset_fletcher32_f	Sets up use of the Fletcher32 checksum filter.
H5Pset_link_phase_change h5pset_link_phase_change_f	Sets the parameters for conversion between compact and dense groups.
H5Pget_link_phase_change h5pget_link_phase_change_f	Queries the settings for conversion between compact and dense groups.
H5Pset_est_link_info h5pset_est_link_info_f	Sets estimated number of links and length of link names in a group.
H5Pget_est_link_info h5pget_est_link_info_f	Queries data required to estimate required local heap or object header size.
H5Pset_nlinks h5pset_nlinks_f	Sets maximum number of soft or user-defined link traversals.
H5Pget_nlinks h5pget_nlinks_f	Retrieves the maximum number of link traversals.
H5Pset_link_creation_order h5pset_link_creation_order_f	Sets creation order tracking and indexing for links in a group.
H5Pget_link_creation_order h5pget_link_creation_order_f	Queries whether link creation order is tracked and/or indexed in a group.
H5Pset_create_intermediate_group h5pset_create_inter_group_f	Specifies in the property list whether to create missing intermediate groups.
H5Pget_create_intermediate_group (none)	Determines whether the property is set to enable creating missing intermediate groups.

H5Pset_char_encoding	Sets the character encoding used to encode a string. Use to set
h5pset_char_encoding_f	ASCII or UTF-8 character encoding for object names.
H5Pget_char_encoding	Retrieves the character encoding used to create a string.
h5pget_char_encoding_f	

Function Listing 4. Other external link functions

C Function	Purpose
Fortran Function	
H5Pset/get_elist_file_cache_size (none)	Sets/retrieves the size of the external link open file cache from the specified file access property list.
H5Fclear_elist_file_cache (none)	Clears the external link open file cache for a file.

4.5. Programming Model: Working with Groups

The programming model for working with groups is as follows:

1. Create a new group or open an existing one.
2. Perform the desired operations on the group.
 - ◆ Create new objects in the group.
 - ◆ Insert existing objects as group members.
 - ◆ Delete existing members.
 - ◆ Open and close member objects.
 - ◆ Access information regarding member objects.
 - ◆ Iterate across group members.
 - ◆ Manipulate links.
3. Terminate access to the group. (Close the group.)

4.5.1 Creating a Group

To create a group, use `H5Gcreate`, specifying the location and the path of the new group. The location is the identifier of the file or the group in a file with respect to which the new group is to be identified. The path is a string that provides wither an absolute path or a relative path to the new group (see section 2.3, “HDF5 Path Names”). A path that begins with a slash (/) is an absolute path indicating that it locates the new group from the root group of the HDF5 file. A path that begins with any other character is a relative path. When the location is a file, a relative path is a path from that file’s root group; when the location is a group, a relative path is a path from that group.

The sample code in the example below creates three groups. The group `Data` is created in the root directory; two groups are then created in `/Data`, one with absolute path, the other with a relative path.

```
hid_t file;
file = H5Fopen(...);

group = H5Gcreate(file, "/Data", H5P_DEFAULT, H5P_DEFAULT, H5P_DEFAULT);
group_new1 = H5Gcreate(file, "/Data/Data_new1", H5P_DEFAULT, H5P_DEFAULT,
    H5P_DEFAULT);
group_new2 = H5Gcreate(group, "Data_new2", H5P_DEFAULT, H5P_DEFAULT,
    H5P_DEFAULT);
```

Example 1. Creating three new groups

The third `H5Gcreate` parameter optionally specifies how much file space to reserve to store the names that will appear in this group. If a non-positive value is supplied, a default size is chosen.

4.5.2 Opening a Group and Accessing an Object in that Group

Though it is not always necessary, it is often useful to explicitly open a group when working with objects in that group. Using the file created in the example above, the example below illustrates the use of a previously-acquired file identifier and a path relative to that file to open the group `Data`.

Any object in a group can be also accessed by its absolute or relative path. To open an object using a relative path, an application must first open the group or file on which that relative path is based. To open an object using an absolute path, the application can use any location identifier in the same file as the target object; the file identifier is commonly used, but object identifier for any object in that file will work. Both of these approaches are illustrated in the example below.

Using the file created in the examples above, the example below provides sample code illustrating the use of both relative and absolute paths to access an HDF5 data object. The first sequence (two function calls) uses a previously-acquired file identifier to open the group `Data`, and then uses the returned group identifier and a relative path to open the dataset `CData`. The second approach (one function call) uses the same previously-acquired file identifier and an absolute path to open the same dataset.

```
group = H5Gopen(file, "Data", H5P_DEFAULT);
dataset1 = H5Dopen(group, "CData", H5P_DEFAULT);

dataset2 = H5Dopen(file, "/Data/CData", H5P_DEFAULT);
```

Example 2. Open a dataset with relative and absolute paths

4.5.3 Creating a Dataset in a Specific Group

Any dataset must be created in a particular group. As with groups, a dataset may be created in a particular group by specifying its absolute path or a relative path. The example below illustrates both approaches to creating a dataset in the group `/Data`.

```
dataspace = H5Screate_simple(RANK, dims, NULL);
dataset1 = H5Dcreate(file, "/Data/CData", H5T_NATIVE_INT,
                    dataspace, H5P_DEFAULT, H5P_DEFAULT, H5P_DEFAULT);

group = H5Gopen(file, "Data", H5P_DEFAULT);
dataset2 = H5Dcreate(group, "Cdata2", H5T_NATIVE_INT,
                    dataspace, H5P_DEFAULT, H5P_DEFAULT, H5P_DEFAULT);
```

Example 3. Create a dataset with absolute and relative paths

4.5.4 Closing a Group

To ensure the integrity of HDF5 objects and to release system resources, an application should always call the appropriate close function when it is through working with an HDF5 object. In the case of groups, `H5Gclose` ends access to the group and releases any resources the HDF5 Library has maintained in support of that access, including the group identifier.

As illustrated in the example below, all that is required for an `H5Gclose` call is the group identifier acquired when the group was opened; there are no relative versus absolute path considerations.

```
herr_t status;
status = H5Gclose(group);
```

Example 4. Close a group

A non-negative return value indicates that the group was successfully closed and the resources released; a negative return value indicates that the attempt to close the group or release resources failed.

4.5.5 Creating Links

As previously mentioned, every object is created in a specific group. Once created, an object can be made a member of additional groups by means of links created with one of the `H5Lcreate_*` functions.

A link is, in effect, a path by which the target object can be accessed; it therefore has a name which functions as a single path component. A link can be removed with an `H5Ldelete` call, effectively removing the target object from the group that contained the link (assuming, of course, that the removed link was the only link to the target object in the group).

Hard Links

There are two kinds of links, hard links and symbolic links. Hard links are reference counted; symbolic links are not. When an object is created, a hard link is automatically created. An object can be deleted from the file by removing all the hard links to it.

Working with the file from the previous examples, the code in the example below illustrates the creation of a hard link, named `Data_link`, in the root group, `/`, to the group `Data`. Once that link is created, the dataset `Cdata` can be accessed via either of two absolute paths, `/Data/Cdata` or `/Data_Link/Cdata`.

```
status = H5Lcreate_hard(Data_loc_id, "Data", DataLink_loc_id, "Data_link",
                       H5P_DEFAULT, H5P_DEFAULT)

dataset1 = H5Dopen(file, "/Data_link/Cdata", H5P_DEFAULT);
dataset2 = H5Dopen(file, "/Data/Cdata", H5P_DEFAULT);
```

Example 5. Create a hard link

The example below shows example code to delete a link, deleting the hard link `Data` from the root group. The group `/Data` and its members are still in the file, but they can no longer be accessed via a path using the component `/Data`.

```
status = H5Ldelete(Data_loc_id, "Data", H5P_DEFAULT);

dataset1 = H5Dopen(file, "/Data_link/CData", H5P_DEFAULT);
/* This call should succeed; all path component still exist*/
dataset2 = H5Dopen(file, "/Data/CData", H5P_DEFAULT);
/* This call will fail; the path component '/Data' has been deleted*/
```

Example 6. Delete a link

When the last hard link to an object is deleted, the object is no longer accessible. `H5Ldelete` will not prevent you from deleting the last link to an object. To see if an object has only one link, use the `H5Oget_info` function. If the value of the `rc` (reference count) field in the is greater than 1, then the link can be deleted without making the object inaccessible.

The example below shows `H5Oget_info` to the group originally called `Data`.

```
status = H5Oget_info(Data_loc_id, object_info);
```

Example 7. Finding the number of links to an object

It is possible to delete the last hard link to an object and not make the object inaccessible. Suppose your application opens a dataset, and then deletes the last hard link to the dataset. While the dataset is open, your application still has a connection to the dataset. If your application creates a hard link to the dataset before it closes the dataset, then the dataset will still be accessible.

Symbolic Links

Symbolic links are objects that assign a name in a group to a path. Notably, the target object is determined only when the symbolic link is accessed, and may, in fact, not exist. Symbolic links are not reference counted, so there may be zero, one, or more symbolic links to an object.

The major types of symbolic links are soft links and external links. Soft links are symbolic links within an HDF5 file and are created with the `H5Lcreate_soft` function. Symbolic links to objects located in external files, in other words external links, can be created with the `H5Lcreate_external` function. Symbolic links are removed with the `H5Ldelete` function.

The example below shows the creating two soft links to the group `/Data`.

```
status = H5Lcreate_soft(path_to_target, link_loc_id, "Soft2", H5P_DEFAULT, H5P_DEFAULT);
status = H5Lcreate_soft(path_to_target, link_loc_id, "Soft3", H5P_DEFAULT, H5P_DEFAULT);

dataset = H5Dopen(file, "/Soft2/CData", H5P_DEFAULT);
```

Example 8. Create a soft link

With the soft links defined in the example above, the dataset `CData` in the group `/Data` can now be opened with any of the names `/Data/CData`, `/Soft2/CData`, or `/Soft3/CData`.

In release 1.8.7, a cache was added to hold the names of files accessed via external links. The size of this cache can be changed to help improve performance. For more information, see the entry in the *HDF5 Reference Manual* for the `H5Pset_mlink_file_cache_size` function call.

Note Regarding Hard Links and Soft Links

Note that an object's existence in a file is governed by the presence of at least one hard link to that object. If the last hard link to an object is removed, the object is removed from the file and any remaining soft link becomes a dangling link, a link whose target object does not exist.

Moving or Renaming Objects, and a Warning

An object can be renamed by changing the name of a link to it with `H5Lmove`. This has the same effect as creating a new link with the new name and deleting the link with the old name.

Exercise caution in the use of `H5Lmove` and `H5Ldelete` as these functions each include a step that unlinks a pointer to an HDF5 object. If the link that is removed is on the only path leading to an HDF5 object, that object will become permanently inaccessible in the file.

Scenario 1: Removing the Last Link

To avoid removing the last link to an object or otherwise making an object inaccessible, use the `H5Oget_info` function. Make sure that the value of the reference count field (`rc`) is greater than 1.

Scenario 2: Moving a Link that Isolates an Object

Consider the following example: assume that the group `group2` can only be accessed via the following path, where `top_group` is a member of the file's root group:

```
/top_group/group1/group2/
```

Using `H5Lmove`, `top_group` is renamed to be a member of `group2`. At this point, since `top_group` was the only route from the root group to `group1`, there is no longer a path by which one can access `group1`, `group2`, or any member datasets. And since `top_group` is now a member of `group2`, `top_group` itself and any member datasets have thereby also become inaccessible.

4.5.6 Discovering Information about Objects

There is often a need to retrieve information about a particular object. The `H5Lget_info` and `H5Oget_info` functions fill this niche by returning a description of the object or link in an `H5L_info_t` or `H5O_info_t` structure.

4.5.7 Discovering Objects in a Group

To examine all the objects or links in a group, use the `H5Literate` or `H5Ovisit` functions to examine the objects, and use the `H5Lvisit` function to examine the links. `H5Literate` is useful both with a single group and in an iterative process that examines an entire file or section of a file (such as the contents of a group or the contents of all the groups that are members of that group) and acts on objects as they are encountered. `H5Ovisit` recursively visits all objects accessible from a specified object. `H5Lvisit` recursively visits all the links starting from a specified group.

4.5.8 Discovering All the Objects in the File

The structure of an HDF5 file is self-describing, meaning that an application can navigate an HDF5 file to discover and understand all the objects it contains. This is an iterative process wherein the structure is traversed as a graph, starting at one node and recursively visiting linked nodes. To explore the entire file, the traversal should start at the root group.

4.6. Examples of File Structures

This section presents several samples of HDF5 file structures.

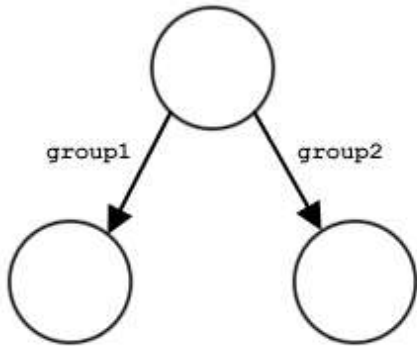

a) The file contains three groups: the root group, /group1, and /group2.

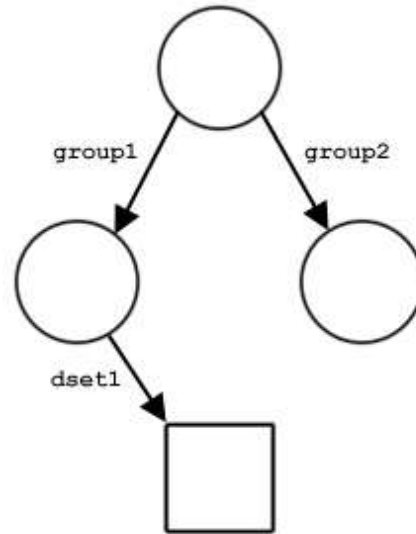

b) The dataset dset1 (or /group1/dset1) is created in /group1.

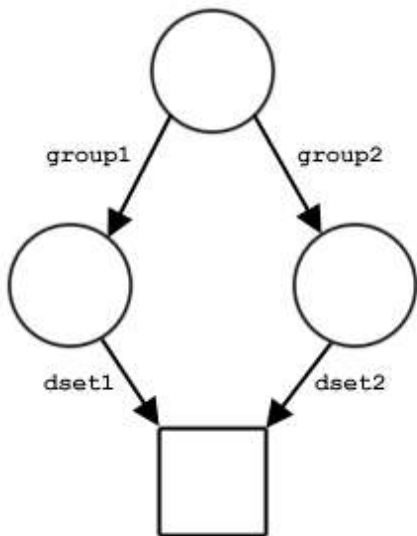

c) A link named dset2 to the same dataset is created in /group2.

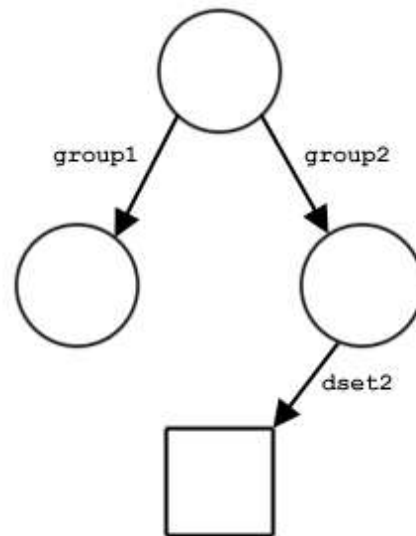

d) The link from /group1 to dset1 is removed. The dataset is still in the file, but can be accessed only as /group2/dset2.

Figure 9. Some file structures

The figure above shows examples of the structure of a file with three groups and one dataset. The file in Figure 9a contains three groups: the root group and two member groups. In Figure 9b, the dataset `dset1` has been created in `/group1`. In Figure 9c, a link named `dset2` from `/group2` to the dataset has been added. Note that there is only one copy of the dataset; there are two links to it and it can be accessed either as `/group1/dset1` or as `/group2/dset2`.

Figure 9d above illustrates that one of the two links to the dataset can be deleted. In this case, the link from `/group1` has been removed. The dataset itself has not been deleted; it is still in the file but can only be accessed as `/group2/dset2`.

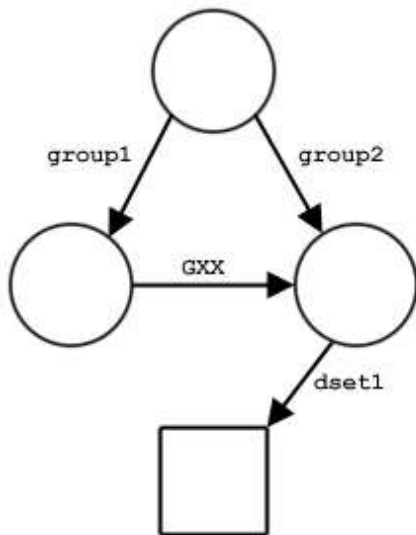

a) `dset1` has two names: `/group2/dset1` and `/group1/GXX/dset1`.

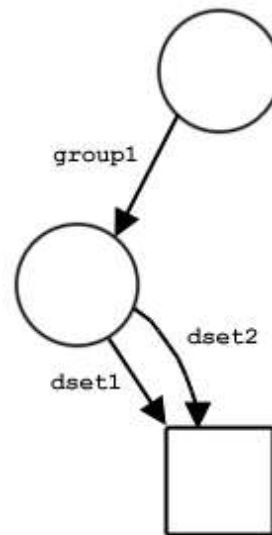

b) `dset1` again has two names: `/group1/dset1` and `/group1/dset2`.

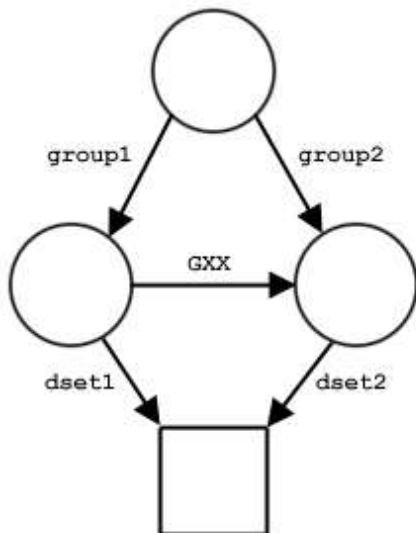

c) `dset1` has three names: `/group1/dset1`, `/group2/dset2`, and `/group1/GXX/dset2`.

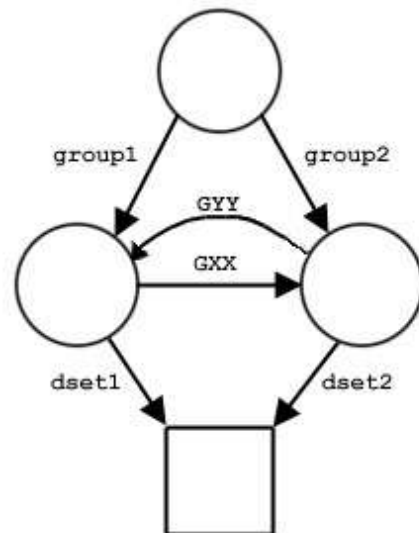

d) `dset1` has an infinite number of available path names.

Figure 10. More sample file structures

The figure above illustrates loops in an HDF5 file structure. The file in Figure 10a contains three groups and a dataset; `group2` is a member of the root group and of the root group's other member group, `group1`. `group2` thus can be accessed by either of two paths: `/group2` or `/group1/GXX`. Similarly, the dataset can be accessed either as `/group2/dset1` or as `/group1/GXX/dset1`.

Figure 10b illustrates a different case: the dataset is a member of a single group but with two links, or names, in that group. In this case, the dataset again has two names, `/group1/dset1` and `/group1/dset2`.

In Figure 10c, the dataset `dset1` is a member of two groups, one of which can be accessed by either of two names. The dataset thus has three path names: `/group1/dset1`, `/group2/dset2`, and `/group1/GXX/dset2`.

And in Figure 10d, two of the groups are members of each other and the dataset is a member of both groups. In this case, there are an infinite number of paths to the dataset because `GXX` and `GYG` can be traversed any number of times on the way from the root group, `/`, to the dataset. This can yield a path name such as `/group1/GXX/GYG/GXX/GYG/GXX/dset2`.

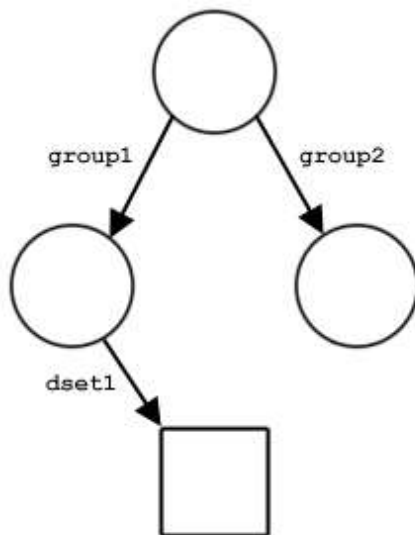

a) The file contains only hard links.

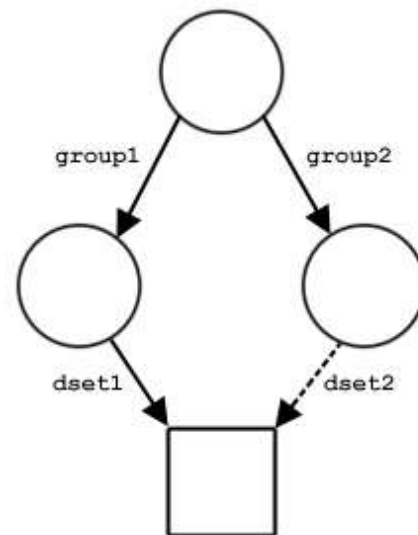
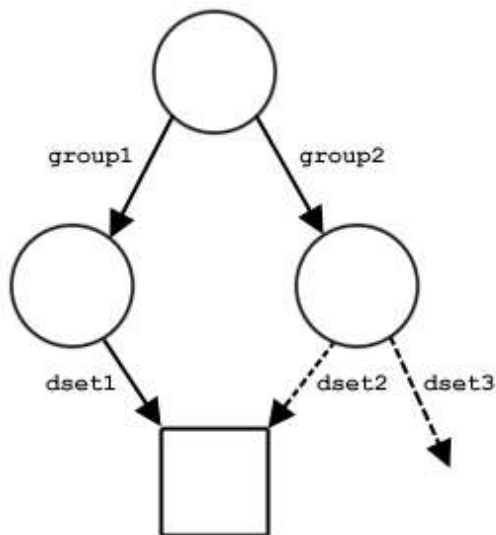
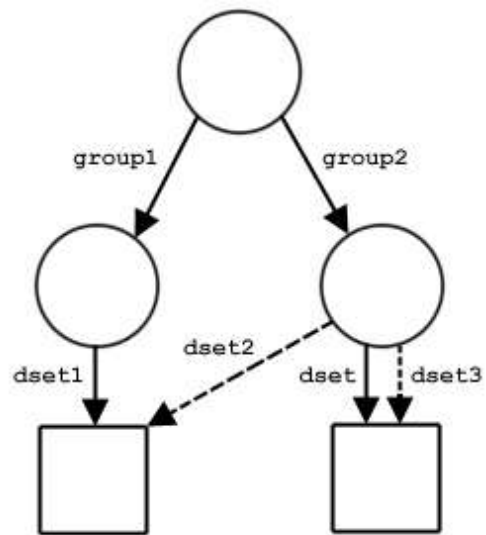
b) A soft link is added from `group2` to `/group1/dset1`.c) A soft link named `dset3` is added with a target that does not yet exist.

d) The target of the soft link is created or linked.

Figure 11. Hard and soft links

The figure above takes us into the realm of soft links. The original file, in Figure 11a, contains only three hard links. In Figure 11b, a soft link named `dset2` from `group2` to `/group1/dset1` has been created, making this dataset accessible as `/group2/dset2`.

In Figure 11c, another soft link has been created in `group2`. But this time the soft link, `dset3`, points to a target object that does not yet exist. That target object, `dset`, has been added in Figure 11d and is now accessible as either `/group2/dset` or `/group2/dset3`.

¹It could be said that HDF5 extends the organizing concepts of a file system to the internal structure of a single file.

Chapter 5

HDF5 Datasets

5.1. Introduction

An HDF5 dataset is an object composed of a collection of data elements, or raw data, and metadata that stores a description of the data elements, data layout, and all other information necessary to write, read, and interpret the stored data. From the viewpoint of the application the raw data is stored as a one-dimensional or multi-dimensional array of elements (the *raw data*), those elements can be any of several numerical or character types, small arrays, or even compound types similar to C structs. The dataset object may have attribute objects. See the figure below.

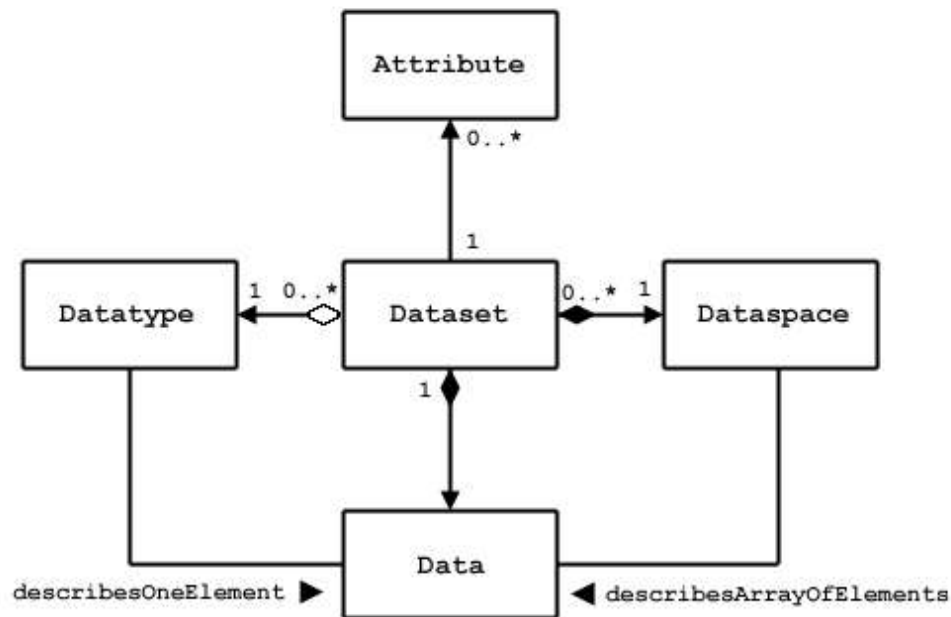

Figure 1. Application view of a dataset

A dataset object is stored in a file in two parts: a header and a data array. The header contains information that is needed to interpret the array portion of the dataset, as well as metadata (or pointers to metadata) that describes or annotates the dataset. Header information includes the name of the object, its dimensionality, its number-type, information about how the data itself is stored on disk (the *storage layout*), and other information used by the library to speed up access to the dataset or maintain the file's integrity.

The HDF5 dataset interface, comprising the H5D functions, provides a mechanism for managing HDF5 datasets including the transfer of data between memory and disk and the description of dataset properties.

A dataset is used by other HDF5 APIs, either by name or by an identifier (e.g., returned by H5Dopen).

Link/Unlink

A dataset can be added to a group with one of the `H5Lcreate` calls, and deleted from a group with `H5Ldelete`. The link and unlink operations use the name of an object, which may be a dataset. The dataset does not have to open to be linked or unlinked.

Object reference

A dataset may be the target of an object reference. The object reference is created by `H5Rcreate` with the name of an object which may be a dataset and the reference type `H5R_OBJECT`. The dataset does not have to be open to create a reference to it.

An object reference may also refer to a region (selection) of a dataset. The reference is created with `H5Rcreate` and a reference type of `H5R_DATASET_REGION`.

An object reference can be accessed by a call to `H5Rdereference`. When the reference is to a dataset or dataset region, the `H5Rdereference` call returns an identifier to the dataset just as if `H5Dopen` has been called.

Adding attributes

A dataset may have user-defined attributes which are created with `H5Acreate` and accessed through the `H5A` API. To create an attribute for a dataset, the dataset must be open, and the identifier is passed to `H5Acreate`. The attributes of a dataset are discovered and opened using `H5Aopen_name`, `H5Aopen_idx`, or `H5Aiterate`; these functions use the identifier of the dataset. An attribute can be deleted with `H5Adelete` which also uses the identifier of the dataset.

5.2. Dataset Function Summaries

Functions that can be used with datasets (H5D functions) and property list functions that can be used with datasets (H5P functions) are listed below.

Function Listing 1. Dataset functions (H5D)

C Function	Fortran Function	Purpose
H5Dcreate	h5dcreate_f	Creates a dataset at the specified location. The C function is a macro; see “API Compatibility Macros in HDF5.”
H5Dcreate_anon	h5dcreate_anon_f	Creates a dataset in a file without linking it into the file structure.
H5Dopen	h5dopen_f	Opens an existing dataset. The C function is a macro; see “API Compatibility Macros in HDF5.”
H5Dclose	h5dclose_f	Closes the specified dataset.
H5Dget_space	h5dget_space_f	Returns an identifier for a copy of the dataspace for a dataset.
H5Dget_space_status	h5dget_space_status_f	Determines whether space has been allocated for a dataset.
H5Dget_type	h5dget_type_f	Returns an identifier for a copy of the datatype for a dataset.
H5Dget_create_plist	h5dget_create_plist_f	Returns an identifier for a copy of the dataset creation property list for a dataset.
H5Dget_access_plist	(none)	Returns the dataset access property list associated with a dataset.
H5Dget_offset	h5dget_offset_f	Returns the dataset address in a file.
H5Dget_storage_size	h5dget_storage_size_f	Returns the amount of storage required for a dataset.
H5Dvlen_get_buf_size	h5dvlen_get_max_len_f	Determines the number of bytes required to store variable-length (VL) data.
H5Dvlen_reclaim	(none)	Reclaims VL datatype memory buffers.
H5Dread	h5dread_f	Reads raw data from a dataset into a buffer.
H5Dwrite	h5dwrite_f	Writes raw data from a buffer to a dataset.
H5Diterate	(none)	Iterates over all selected elements in a dataspace.
H5Dfill	h5dfill_f	Fills dataspace elements with a fill value in a memory buffer.
H5Dset_extent	h5dset_extent_f	Changes the sizes of a dataset's dimensions.

Function Listing 2. Dataset creation property list functions (H5P)

C Function	Purpose
Fortran Function	
H5Pset_layout h5pset_layout_f	Sets the type of storage used to store the raw data for a dataset.
H5Pget_layout h5pget_layout_f	Returns the layout of the raw data for a dataset.
H5Pset_chunk h5pset_chunk_f	Sets the size of the chunks used to store a chunked layout dataset.
H5Pget_chunk h5pget_chunk_f	Retrieves the size of chunks for the raw data of a chunked layout dataset.
H5Pset_deflate h5pset_deflate_f	Sets compression method and compression level.
H5Pset_fill_value h5pset_fill_value_f	Sets the fill value for a dataset.
H5Pget_fill_value h5pget_fill_value_f	Retrieves a dataset fill value.
H5Pfill_value_defined (none)	Determines whether the fill value is defined.
H5Pset_fill_time h5pset_fill_time_f	Sets the time when fill values are written to a dataset.
H5Pget_fill_time h5pget_fill_time_f	Retrieves the time when fill value are written to a dataset.
H5Pset_alloc_time h5pset_alloc_time_f	Sets the timing for storage space allocation.
H5Pget_alloc_time h5pget_alloc_time_f	Retrieves the timing for storage space allocation.
H5Pset_filter h5pset_filter_f	Adds a filter to the filter pipeline.
H5Pall_filters_avail (none)	Verifies that all required filters are available.
H5Pget_nfilters h5pget_nfilters_f	Returns the number of filters in the pipeline.
H5Pget_filter h5pget_filter_f	Returns information about a filter in a pipeline. The C function is a macro: see “API Compatibility Macros in HDF5.”
H5Pget_filter_by_id h5pget_filter_by_id_f	Returns information about the specified filter. The C function is a macro: see “API Compatibility Macros in HDF5.”
H5Pmodify_filter h5pmodify_filter_f	Modifies a filter in the filter pipeline.
H5Premove_filter h5premove_filter_f	Deletes one or more filters in the filter pipeline.
H5Pset_fletcher32 h5pset_fletcher32_f	Sets up use of the Fletcher32 checksum filter.
H5Pset_nbit h5pset_nbit_f	Sets up use of the n-bit filter.

H5Pset_scaleoffset	Sets up use of the scale-offset filter.
h5pset_scaleoffset_f	
H5Pset_shuffle	Sets up use of the shuffle filter.
h5pset_shuffle_f	
H5Pset_szip	Sets up use of the Szip compression filter.
h5pset_szip_f	
H5Pset_external	Adds an external file to the list of external files.
h5pset_external_f	
H5Pget_external_count	Returns the number of external files for a dataset.
h5pget_external_count_f	
H5Pget_external	Returns information about an external file.
h5pget_external_f	
H5Pset_char_encoding	Sets the character encoding used to encode a string. Use to set ASCII or UTF-8 character encoding for object names.
h5pset_char_encoding_f	
H5Pget_char_encoding	Retrieves the character encoding used to create a string.
h5pget_char_encoding_f	

Function Listing 3. Dataset access property list functions (H5P)

C Function	Purpose
Fortran Function	
H5Pset_buffer	Sets type conversion and background buffers.
h5pset_buffer_f	
H5Pget_buffer	Reads buffer settings.
h5pget_buffer_f	
H5Pset_chunk_cache	Sets the raw data chunk cache parameters.
h5pset_chunk_cache_f	
H5Pget_chunk_cache	Retrieves the raw data chunk cache parameters.
h5pget_chunk_cache_f	
H5Pset_edc_check	Sets whether to enable error-detection when reading a dataset.
h5pset_edc_check_f	
H5Pget_edc_check	Determines whether error-detection is enabled for dataset reads.
h5pget_edc_check_f	
H5Pset_filter_callback	Sets user-defined filter callback function.
(none)	
H5Pset_data_transform	Sets a data transform expression.
h5pset_data_transform_f	
H5Pget_data_transform	Retrieves a data transform expression.
h5pget_data_transform_f	
H5Pset_type_conv_cb	Sets user-defined datatype conversion callback function.
(none)	
H5Pget_type_conv_cb	Gets user-defined datatype conversion callback function.
(none)	
H5Pset_hyper_vector_size	Sets number of I/O vectors to be read/written in hyperslab I/O.
h5pset_hyper_vector_size_f	

H5Pget_hyper_vector_size h5pget_hyper_vector_size_f	Retrieves number of I/O vectors to be read/written in hyperslab I/O.
H5Pset_btree_ratios h5pset_btree_ratios_f	Sets B-tree split ratios for a dataset transfer property list.
H5Pget_btree_ratios h5pget_btree_ratios_f	Gets B-tree split ratios for a dataset transfer property list.
H5Pset_vlen_mem_manager (none)	Sets the memory manager for variable-length datatype allocation in H5Dread and H5Dvlen_reclaim.
H5Pget_vlen_mem_manager (none)	Gets the memory manager for variable-length datatype allocation in H5Dread and H5Dvlen_reclaim.
H5Pset_dxpl_mpio h5pset_dxpl_mpio_f	Sets data transfer mode.
H5Pget_dxpl_mpio h5pget_dxpl_mpio_f	Returns the data transfer mode.
H5Pset_dxpl_mpio_chunk_opt (none)	Sets a flag specifying linked-chunk I/O or multi-chunk I/O.
H5Pset_dxpl_mpio_chunk_opt_num (none)	Sets a numeric threshold for linked-chunk I/O.
H5Pset_dxpl_mpio_chunk_opt_ratio (none)	Sets a ratio threshold for collective I/O.
H5Pset_dxpl_mpio_collective_opt (none)	Sets a flag governing the use of independent versus collective I/O.
H5Pset_dxpl_multi (none)	Sets the data transfer property list for the multi-file driver.
H5Pget_dxpl_multi (none)	Returns multi-file data transfer property list information.
H5Pset_multi_type (none)	Sets the type of data property for the MULTI driver.
H5Pget_multi_type (none)	Retrieves the type of data property for the MULTI driver.
H5Pset_small_data_block_size h5pset_small_data_block_size_f	Sets the size of a contiguous block reserved for small data.
H5Pget_small_data_block_size h5pget_small_data_block_size_f	Retrieves the current small data block size setting.

5.3. Programming Model

This section explains the programming model for datasets.

5.3.1. General Model

The programming model for using a dataset has three main phases:

- Obtain access to the dataset
- Operate on the dataset using the dataset identifier returned at access
- Release the dataset

These three phases or steps are described in more detail below the figure.

A dataset may be opened several times and operations performed with several different identifiers to the same dataset. All the operations affect the dataset although the calling program must synchronize if necessary to serialize accesses.

Note that the dataset remains open until every identifier is closed. The figure below shows the basic sequence of operations.

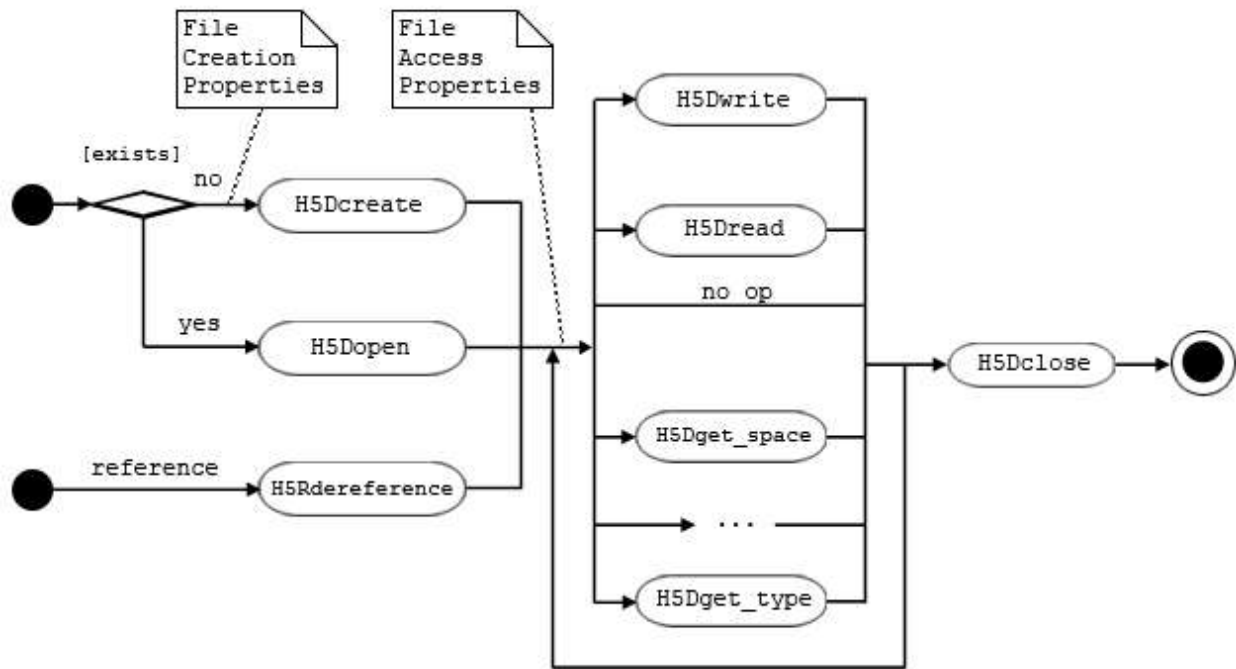

Figure 2. Dataset programming sequence

Creation and data access operations may have optional parameters which are set with property lists. The general programming model is:

- Create property list of appropriate class (dataset create, dataset transfer)
- Set properties as needed; each type of property has its own format and datatype
- Pass the property list as a parameter of the API call

The steps below describe the programming phases or steps for using a dataset.

Step 1. Obtain Access

A new dataset is created by a call to `H5Dcreate`. If successful, the call returns an identifier for the newly created dataset.

Access to an existing dataset is obtained by a call to `H5Dopen`. This call returns an identifier for the existing dataset.

An object reference may be dereferenced to obtain an identifier to the dataset it points to.

In each of these cases, the successful call returns an identifier to the dataset. The identifier is used in subsequent operations until the dataset is closed.

Step 2. Operate on the Dataset

The dataset identifier can be used to write and read data to the dataset, to query and set properties, and to perform other operations such as adding attributes, linking in groups, and creating references.

The dataset identifier can be used for any number of operations until the dataset is closed.

Step 3. Close the Dataset

When all operations are completed, the dataset identifier should be closed. This releases the dataset.

After the identifier is closed, it cannot be used for further operations.

5.3.2. Create Dataset

A dataset is created and initialized with a call to `H5Dcreate`. The dataset create operation sets permanent properties of the dataset:

- Name
- Dataspace
- Datatype
- Storage properties

These properties cannot be changed for the life of the dataset, although the dataspace may be expanded up to its maximum dimensions.

Name

A dataset name is a sequence of alphanumeric ASCII characters. The full name would include a tracing of the group hierarchy from the root group of the file, e.g., `/rootGroup/groupA/subgroup23/dataset1`. The local name or relative name within the lowest-level group containing the dataset would include none of the group hierarchy. e.g., `Dataset1`.

Dataspace

The dataspace of a dataset defines the number of dimensions and the size of each dimension. The dataspace defines the number of dimensions, and the maximum dimension sizes and current size of each dimension. The maximum dimension size can be a fixed value or the constant `H5D_UNLIMITED`, in which case the actual dimension size can be changed with calls to `H5Dset_extent`, up to the maximum set with the `maxdims` parameter in the `H5Screate_simple` call that established the dataset's original dimensions. The maximum dimension size is set when the dataset is created and cannot be changed.

Datatype

Raw data has a datatype which describes the layout of the raw data stored in the file. The datatype is set when the dataset is created and can never be changed. When data is transferred to and from the dataset, the HDF5 Library will assure that the data is transformed to and from the stored format.

Storage Properties

Storage properties of the dataset are set when it is created. The required inputs table below shows the categories of storage properties. The storage properties cannot be changed after the dataset is created.

Filters

When a dataset is created, optional filters are specified. The filters are added to the data transfer pipeline when data is read or written. The standard library includes filters to implement compression, data shuffling, and error detection code. Additional user-defined filters may also be used.

The required filters are stored as part of the dataset, and the list may not be changed after the dataset is created. The HDF5 Library automatically applies the filters whenever data is transferred.

Summary

A newly created dataset has no attributes and no data values. The dimensions, datatype, storage properties, and selected filters are set. The table below lists the required inputs, and the second table below lists the optional inputs.

Table 1. Required inputs

Required Inputs	Description
Dataspace	The shape of the array.
Datatype	The layout of the stored elements.
Name	The name of the dataset in the group.

Table 2. Optional inputs

Optional Inputs	Description
Storage Layout	How the data is organized in the file including chunking.
Fill Value	The behavior and value for uninitialized data.
External Storage	Option to store the raw data in an external file.
Folders	Select optional filters to be applied, e.g., compression.

Example

To create a new dataset

Set dataset characteristics. (Optional where default settings are acceptable)

Datatype

Dataspace

Dataset creation property list Create the dataset.

Close the datatype, dataspace, and property list (as necessary).

Close the dataset.

Example 1 below shows example code to create an empty dataset. The dataspace is 7 x 8, and the datatype is a big-endian integer. The dataset is created with the name “dset1” and is a member of the root group, “/”.

```

hid_t    dataset, datatype, dataspace;

/*
 * Create dataspace: Describe the size of the array and
 * create the dataspace for fixed-size dataset.
 */
dimsf[0] = 7;
dimsf[1] = 8;
dataspace = H5Screate_simple(2, dimsf, NULL);
/*
 * Define datatype for the data in the file.
 * For this example, store little-endian integer numbers.
 */
datatype = H5Tcopy(H5T_NATIVE_INT);
status = H5Tset_order(datatype, H5T_ORDER_LE);
/*
 * Create a new dataset within the file using defined
 * dataspace and datatype. No properties are set.
 */
dataset = H5Dcreate(file, "/dset", datatype, dataspace, H5P_DEFAULT,
                   H5P_DEFAULT, H5P_DEFAULT);

H5Dclose(dataset);
H5Sclose(dataspace);
H5Tclose(datatype);

```

Example 1. Create an empty dataset

Example 2 below shows example code to create a similar dataset with a fill value of '-1'. This code has the same steps as in the example above, but uses a non-default property list. A file creation property list is created, and then the fill value is set to the desired value. Then the property list is passed to the `H5Dcreate` call.

```

hid_t    dataset, datatype, dataspace;
hid_t    plist; /* property list */
int      fillval = -1;
dimsf[0] = 7;
dimsf[1] = 8;
dataspace = H5Screate_simple(2, dimsf, NULL);

datatype = H5Tcopy(H5T_NATIVE_INT);
status = H5Tset_order(datatype, H5T_ORDER_LE);

/*
 * Example of Dataset Creation property list: set fill value to '-1'
 */
plist = H5Pcreate(H5P_DATASET_CREATE);
status = H5Pset_fill_value(plist, datatype, &fillval);

/* Same as above, but use the property list */
dataset = H5Dcreate(file, "/dset", datatype, dataspace, H5P_DEFAULT,
                   plist, H5P_DEFAULT);

H5Dclose(dataset);
H5Sclose(dataspace);
H5Tclose(datatype);
H5Pclose(plist);

```

Example 2. Create a dataset with fill value set to -1

After this code is executed, the dataset has been created and written to the file. The data array is uninitialized. Depending on the storage strategy and fill value options that have been selected, some or all of the space may be allocated in the file, and fill values may be written in the file.

5.3.3. Data Transfer Operations on a Dataset

Data is transferred between memory and the raw data array of the dataset through `H5Dwrite` and `H5Dread` operations. A data transfer has the following basic steps:

1. Allocate and initialize memory space as needed
2. Define the datatype of the memory elements
3. Define the elements to be transferred (a selection, or all the elements)
4. Set data transfer properties (including parameters for filters or file drivers) as needed
5. Call the H5D API

Note that the location of the data in the file, the datatype of the data in the file, the storage properties, and the filters do not need to be specified because these are stored as a permanent part of the dataset. A selection of elements from the dataspace is specified; the selected elements may be the whole dataspace.

The figure below shows a diagram of a write operation which transfers a data array from memory to a dataset in the file (usually on disk). A read operation has similar parameters with the data flowing the other direction.

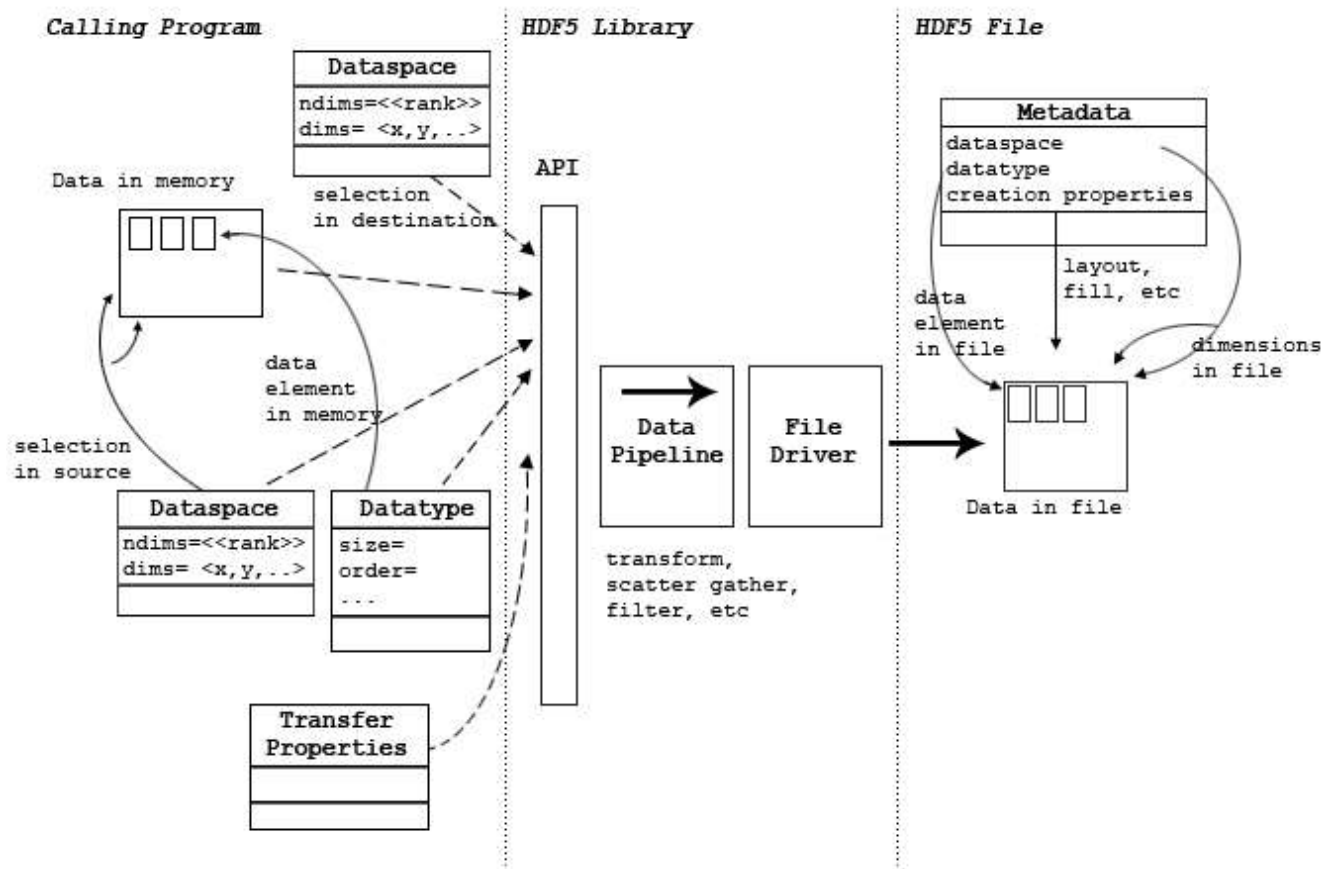

Figure 3. A write operation

Memory Space

The calling program must allocate sufficient memory to store the data elements to be transferred. For a write (from memory to the file), the memory must be initialized with the data to be written to the file. For a read, the memory must be large enough to store the elements that will be read. The amount of storage needed can be computed from the memory datatype (which defines the size of each data element) and the number of elements in the selection.

Memory Datatype

The memory layout of a single data element is specified by the memory datatype. This specifies the size, alignment, and byte order of the element as well as the datatype class. Note that the memory datatype must be the same datatype class as the file, but may have different byte order and other properties. The HDF5 Library automatically transforms data elements between the source and destination layouts. See the chapter “HDF5 Datatypes” for more details.

For a write, the memory datatype defines the layout of the data to be written; an example is IEEE floating-point numbers in native byte order. If the file datatype (defined when the dataset is created) is different but compatible, the HDF5 Library will transform each data element when it is written. For example, if the file byte order is

different than the native byte order, the HDF5 Library will swap the bytes.

For a read, the memory datatype defines the desired layout of the data to be read. This must be compatible with the file datatype, but should generally use native formats, e.g., byte orders. The HDF5 Library will transform each data element as it is read.

Selection

The data transfer will transfer some or all of the elements of the dataset depending on the dataspace selection. The selection has two dataspace objects: one for the source, and one for the destination. These objects describe which elements of the dataspace to be transferred. Some (partial I/O) or all of the data may be transferred. Partial I/O is defined by defining hyperslabs or lists of elements in a dataspace object.

The dataspace selection for the source defines the indices of the elements to be read or written. The two selections must define the same number of points, but the order and layout may be different. The HDF5 Library automatically selects and distributes the elements according to the selections. It might, for example, perform a scatter-gather or sub-set of the data.

Data Transfer Properties

For some data transfers, additional parameters should be set using the transfer property list. The table below lists the categories of transfer properties. These properties set parameters for the HDF5 Library and may be used to pass parameters for optional filters and file drivers. For example, transfer properties are used to select independent or collective operation when using MPI-I/O.

Table 3. Categories of transfer properties

Properties	Description
Library parameters	Internal caches, buffers, B-Trees, etc.
Memory management	Variable-length memory management, data overwrite
File driver management	Parameters for file drivers
Filter management	Parameters for filters

Data Transfer Operation (Read or Write)

The data transfer is done by calling `H5Dread` or `H5Dwrite` with the parameters described above. The HDF5 Library constructs the required pipeline, which will scatter-gather, transform datatypes, apply the requested filters, and use the correct file driver.

During the data transfer, the transformations and filters are applied to each element of the data in the required order until all the data is transferred.

Summary

To perform a data transfer, it is necessary to allocate and initialize memory, describe the source and destination, set required and optional transfer properties, and call the H5D API.

Examples

The basic procedure to **write** to a dataset is the following:

Open the dataset.

Set the dataset dataspace for the write (optional if dataspace is H5S_SELECT_ALL).

Write data.

Close the datatype, dataspace, and property list (as necessary).

Close the dataset.

Example 3 below shows example code to write a 4 x 6 array of integers. In the example, the data is initialized in the memory array `dset_data`. The dataset has already been created in the file, so it is opened with `H5Dopen`.

The data is written with `H5Dwrite`. The arguments are the dataset identifier, the memory datatype (`H5T_NATIVE_INT`), the memory and file selections (`H5S_ALL` in this case: the whole array), and the default (empty) property list. The last argument is the data to be transferred.

```

hid_t      file_id, dataset_id; /* identifiers */
herr_t     status;
int        i, j, dset_data[4][6];

/* Initialize the dataset. */
for (i = 0; i < 4; i++)
    for (j = 0; j < 6; j++)
        dset_data[i][j] = i * 6 + j + 1;

/* Open an existing file. */
file_id = H5Fopen("dset.h5", H5F_ACC_RDWR, H5P_DEFAULT);

/* Open an existing dataset. */
dataset_id = H5Dopen(file_id, "/dset", H5P_DEFAULT);

/* Write the entire dataset, using 'dset_data':
   memory type is 'native int'
   write the entire dataspace to the entire dataspace,
   no transfer properties,
*/
status = H5Dwrite(dataset_id, H5T_NATIVE_INT, H5S_ALL,
                  H5S_ALL, H5P_DEFAULT, dset_data);

status = H5Dclose(dataset_id);

```

Example 3. Write an array of integers

Example 4 below shows a similar write except for setting a non-default value for the transfer buffer. The code is the same as Example 3, but a transfer property list is created, and the desired buffer size is set. The `H5Dwrite` function has the same arguments, but uses the property list to set the buffer.

```

hid_t      file_id, dataset_id;
hid_t      xferplist;
herr_t     status;
int        i, j, dset_data[4][6];

file_id = H5Fopen("dset.h5", H5F_ACC_RDWR, H5P_DEFAULT);

dataset_id = H5Dopen(file_id, "/dset", H5P_DEFAULT);

/*
 * Example: set type conversion buffer to 64MB
 */
xferplist = H5Pcreate(H5P_DATASET_XFER);
status = H5Pset_buffer( xferplist, 64 * 1024 * 1024, NULL, NULL);

/* Write the entire dataset, using 'dset_data':
   memory type is 'native int'
   write the entire dataspace to the entire dataspace,
   set the buffer size with the property list,
 */
status = H5Dwrite(dataset_id, H5T_NATIVE_INT, H5S_ALL,
                  H5S_ALL, xferplist, dset_data);

status = H5Dclose(dataset_id);

```

Example 4. Write an array using a property list

The basic procedure to **read** from a dataset is the following:

- Define the memory dataspace of the read (optional if dataspace is `H5S_SELECT_ALL`).
- Open the dataset.
- Get the dataset dataspace (if using `H5S_SELECT_ALL` above).

- Else define dataset dataspace of read. Define the memory datatype (optional).
- Define the memory buffer.
- Open the dataset.
- Read data.
- Close the datatype, dataspace, and property list (as necessary).
- Close the dataset.

The example below shows code that reads a 4 x 6 array of integers from a dataset called “dset1”. First, the dataset is opened. The H5Dread call has parameters:

- The dataset identifier (from H5Dopen)
- The memory datatype (H5T_NATIVE_INT)
- The memory and file dataspace (H5S_ALL, the whole array)
- A default (empty) property list
- The memory to be filled

```

hid_t      file_id, dataset_id;
herr_t     status;
int        i, j, dset_data[4][6];

/* Open an existing file. */
file_id = H5Fopen("dset.h5", H5F_ACC_RDWR, H5P_DEFAULT);

/* Open an existing dataset. */
dataset_id = H5Dopen(file_id, "/dset", H5P_DEFAULT);

/* read the entire dataset, into 'dset_data':
   memory type is 'native int'
   read the entire dataspace to the entire dataspace,
   no transfer properties,
*/
status = H5Dread(dataset_id, H5T_NATIVE_INT, H5S_ALL,
                 H5S_ALL, H5P_DEFAULT, dset_data);

status = H5Dclose(dataset_id);

```

Example 5. Read an array from a dataset

5.3.4. Retrieve the Properties of a Dataset

The functions listed below allow the user to retrieve information regarding a dataset including the datatype, the dataspace, the dataset creation property list, and the total stored size of the data.

Function Listing 4. Retrieve dataset information

Query Function	Description
H5Dget_space	Retrieve the dataspace of the dataset as stored in the file.
H5Dget_type	Retrieve the datatype of the dataset as stored in the file.
H5Dget_create_plist	Retrieve the dataset creation properties.
H5Dget_storage_size	Retrieve the total bytes for all the data of the dataset.
H5Dvlen_get_buf_size	Retrieve the total bytes for all the variable-length data of the dataset.

The example below illustrates how to retrieve dataset information.

```
hid_t      file_id, dataset_id;
hid_t      dspace_id, dtype_id, plist_id;
herr_t     status;

/* Open an existing file. */
file_id = H5Fopen("dset.h5", H5F_ACC_RDWR, H5P_DEFAULT);

/* Open an existing dataset. */
dataset_id = H5Dopen(file_id, "/dset", H5P_DEFAULT);

dspace_id = H5Dget_space(dataset_id);
dtype_id = H5Dget_type(dataset_id);
plist_id = H5Dget_create_plist(dataset_id);

/* use the objects to discover the properties of the dataset */

status = H5Dclose(dataset_id);
```

Example 6. Retrieve dataset information

5.4. Data Transfer

The HDF5 Library implements data transfers through a pipeline which implements data transformations (according to the datatype and selections), chunking (as requested), and I/O operations using different mechanisms (file drivers). The pipeline is automatically configured by the HDF5 Library. Metadata is stored in the file so that the correct pipeline can be constructed to retrieve the data. In addition, optional filters such as compression may be added to the standard pipeline.

The figure below illustrates data layouts for different layers of an application using HDF5. The application data is organized as a multidimensional array of elements. The HDF5 format specification defines the stored layout of the data and metadata. The storage layout properties define the organization of the abstract data. This data is written and read to and from some storage medium.

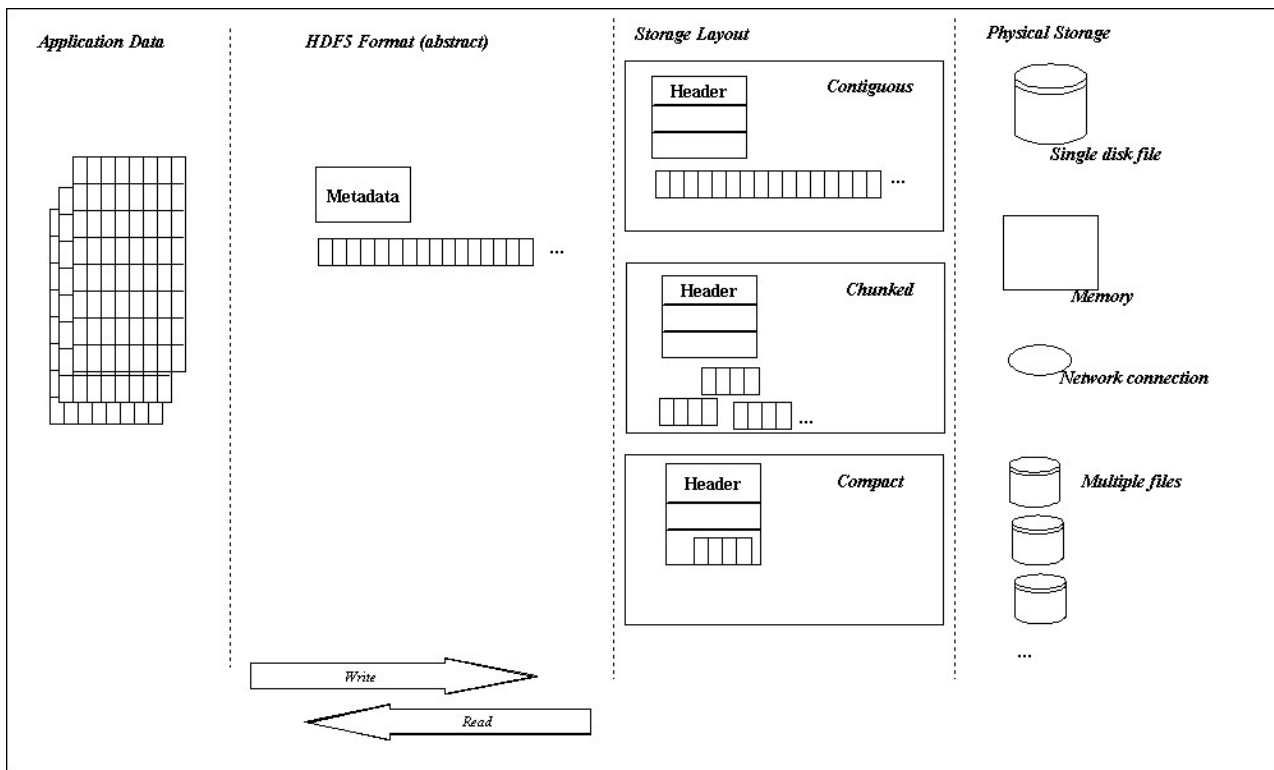

Figure 4. Data layouts in an application

The last stage of a write (and first stage of a read) is managed by an HDF5 file driver module. The virtual file layer of the HDF5 Library implements a standard interface to alternative I/O methods, including memory (AKA “core”) files, single serial file I/O, multiple file I/O, and parallel I/O. The file driver maps a simple abstract HDF5 file to the specific access methods.

The raw data of an HDF5 dataset is conceived to be a multidimensional array of data elements. This array may be stored in the file according to several storage strategies:

- Contiguous
- Chunked
- Compact

The storage strategy does not affect data access methods except that certain operations may be more or less efficient depending on the storage strategy and the access patterns.

Overall, the data transfer operations (`H5Dread` and `H5Dwrite`) work identically for any storage method, for any file driver, and for any filters and transformations. The HDF5 Library automatically manages the data transfer process. In some cases, transfer properties should or must be used to pass additional parameters such as MPI/IO directives when used the parallel file driver.

5.4.1. The Data Pipeline

When data is written or read to or from an HDF5 file, the HDF5 Library passes the data through a sequence of processing steps which are known as the HDF5 data pipeline. This data pipeline performs operations on the data in memory such as byte swapping, alignment, scatter-gather, and hyperslab selections. The HDF5 Library automatically determines which operations are needed and manages the organization of memory operations such as extracting selected elements from a data block. The data pipeline modules operate on data buffers: each module processes a buffer and passes the transformed buffer to the next stage.

The table below lists the stages of the data pipeline. The figure below the table shows the order of processing during a read or write.

Table 4. Stages of the data pipeline

Layers	Description
I/O initiation	Initiation of HDF5 I/O activities (<code>H5Dwrite</code> and <code>H5Dread</code>) in a user’s application program.
Memory hyperslab operation	Data is scattered to (for read), or gathered from (for write) the application’s memory buffer (bypassed if no datatype conversion is needed).
Datatype conversion	Datatype is converted if it is different between memory and storage (bypassed if no datatype conversion is needed).
File hyperslab operation	Data is gathered from (for read), or scattered to (for write) to file space in memory (bypassed if no datatype conversion is needed).
Filter pipeline	Data is processed by filters when it passes. Data can be modified and restored here (bypassed if no datatype conversion is needed, no filter is enabled, or dataset is not chunked).
Virtual File Layer	Facilitate easy plug-in file drivers such as MPIIO or POSIX I/O.
Actual I/O	Actual file driver used by the library such as MPIIO or STDIO.

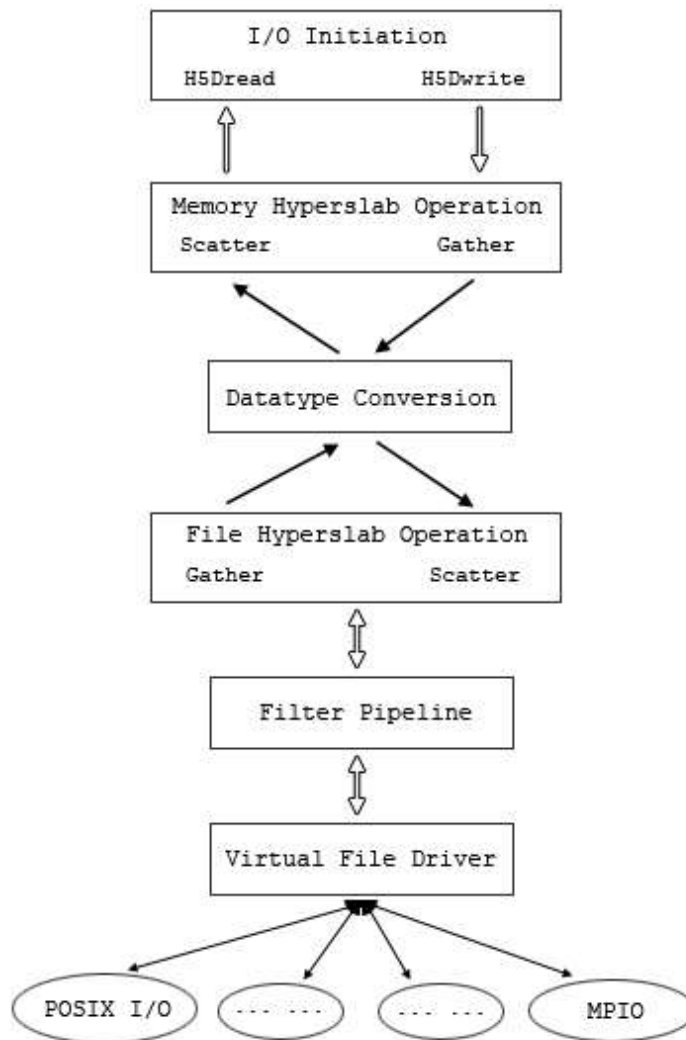

Figure 5. The processing order in the data pipeline

The HDF5 Library automatically applies the stages as needed.

When the memory dataspace selection is other than the whole dataspace, the memory hyperslab stage scatters/gathers the data elements between the application memory (described by the selection) and a contiguous memory buffer for the pipeline. On a write, this is a gather operation; on a read, this is a scatter operation.

When the memory datatype is different from the file datatype, the datatype conversion stage transforms each data element. For example, if data is written from 32-bit big-endian memory, and the file datatype is 32-bit little-endian, the datatype conversion stage will swap the bytes of every elements. Similarly, when data is read from the file to native memory, byte swapping will be applied automatically when needed.

The file hyperslab stage is similar to the memory hyperslab stage, but is managing the arrangement of the elements according to the dataspace selection. When data is read, data elements are gathered from the data blocks from the file to fill the contiguous buffers which are then processed by the pipeline. When data is read, the elements from a buffer are scattered to the data blocks of the file.

5.4.2. Data Pipeline Filters

In addition to the standard pipeline, optional stages, called filters, can be inserted in the pipeline. The standard distribution includes optional filters to implement compression and error checking. User applications may add custom filters as well.

The HDF5 Library distribution includes or employs several optional filters. These are listed in the table below. The filters are applied in the pipeline between the virtual file layer and the file hyperslab operation. See the figure above. The application can use any number of filters in any order.

Table 5. Data pipeline filters

Filter	Description
gzip compression	Data compression using <code>zlib</code> .
Szip compression	Data compression using the Szip library. See The HDF Group website for more information regarding the Szip filter.
N-bit compression	Data compression using an algorithm specialized for n-bit datatypes.
Scale-offset compression	Data compression using using a “scale and offset” algorithm.
Shuffling	To improve compression performance, data is regrouped by its byte position in the data unit. In other words, the 1 st , 2 nd , 3 rd , and 4 th bytes of integers are stored together respectively.
Fletcher32	Fletcher32 checksum for error-detection.

Filters may be used only for chunked data and are applied to chunks of data between the file hyperslab stage and the virtual file layer. At this stage in the pipeline, the data is organized as fixed-size blocks of elements, and the filter stage processes each chunk separately.

Filters are selected by dataset creation properties, and some behavior may be controlled by data transfer properties. The library determines what filters must be applied and applies them in the order in which they were set by the application. That is, if an application calls `H5Pset_shuffle` and then `H5Pset_deflate` when creating a dataset's creation property list, the library will apply the shuffle filter first and then the deflate filter.

Information regarding the n-bit and scale-offset filters can be found in [Using the N-bit Filter](#) and [Using the Scale-offset Filter](#), respectively.

5.4.3. File Drivers

I/O is performed by the HDF5 virtual file layer. The file driver interface writes and reads blocks of data; each driver module implements the interface using different I/O mechanisms. The table below lists the file drivers currently supported. Note that the I/O mechanisms are separated from the pipeline processing: the pipeline and filter operations are identical no matter what data access mechanism is used.

Table 6. I/O file drivers

File Driver	Description
H5FD_CORE	Store in memory (optional backing store to disk file).
H5FD_FAMILY	Store in a set of files.
H5FD_LOG	Store in logging file.
H5FD_MPIO	Store using MPI/IO.
H5FD_MULTII	Store in multiple files. There are several options to control layout.
H5FD_SEC2	Serial I/O to file using Unix “section 2” functions.
H5FD_STDIO	Serial I/O to file using Unix “stdio” functions.

Each file driver writes/reads contiguous blocks of bytes from a logically contiguous address space. The file driver is responsible for managing the details of the different physical storage methods.

In serial environments, everything above the virtual file layer tends to work identically no matter what storage method is used.

Some options may have substantially different performance depending on the file driver that is used. In particular, multi-file and parallel I/O may perform considerably differently from serial drivers depending on chunking and other settings.

5.4.4. Data Transfer Properties to Manage the Pipeline

Data transfer properties set optional parameters that control parts of the data pipeline. The function listing below shows transfer properties that control the behavior of the library.

Function Listing 5. Data transfer property list functions

Property	Description
H5Pset_buffer	Maximum size for the type conversion buffer and the background buffer. May also supply pointers to application-allocated buffers.
H5Pset_hyper_cache	Whether to cache hyperslab blocks during I/O.
H5Pset_btree_ratios	Set the B-tree split ratios for a dataset transfer property list. The split ratios determine what percent of children go in the first node when a node splits.

Some filters and file drivers require or use additional parameters from the application program. These can be passed in the data transfer property list. The table below shows file driver property list functions.

Function Listing 6. File driver property list functions

Property	Description
H5Pset_dxpl_mpio	Control the MPI I/O transfer mode (independent or collective) during data I/O operations.
H5Pset_dxpl_multi	Sets the data transfer property list for the multi-file driver.
H5Pset_small_data_block_size	Reserves blocks of size bytes for the contiguous storage of the raw data portion of small datasets. The HDF5 Library then writes the raw data from small datasets to this reserved space which reduces unnecessary discontinuities within blocks of metadata and improves I/O performance.
H5Pset_edc_check	Disable/enable EDC checking for read. When selected, EDC is always written.

The transfer properties are set in a property list which is passed as a parameter of the `H5Dread` or `H5Dwrite` call. The transfer properties are passed to each pipeline stage. Each stage may use or ignore any property in the list. In short, there is one property list that contains all the properties.

5.4.5. Storage Strategies

The raw data is conceptually a multi-dimensional array of elements that is stored as a contiguous array of bytes. The data may be physically stored in the file in several ways. The table below lists the storage strategies for a dataset.

Table 7. Dataset storage strategies

Storage Strategy	Description
Contiguous	The dataset is stored as one continuous array of bytes.
Chunked	The dataset is stored as fixed-size chunks.
Compact	A small dataset is stored in the metadata header.

The different storage strategies do not affect the data transfer operations of the dataset: reads and writes work the same for any storage strategy.

These strategies are described in the following sections.

Contiguous

A contiguous dataset is stored in the file as a header and a single continuous array of bytes. See the figure below. In the case of a multi-dimensional array, the data is serialized in row major order. By default, data is stored contiguously.

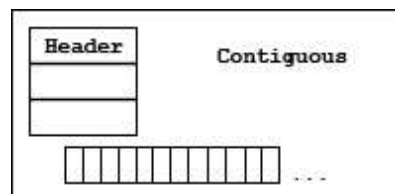

Figure 6. Contiguous data storage

Contiguous storage is the simplest model. It has several limitations. First, the dataset must be a fixed-size: it is not possible to extend the limit of the dataset or to have unlimited dimensions. In other words, if the number of dimensions of the array might change over time, then chunking storage must be used instead of contiguous. Second, because data is passed through the pipeline as fixed-size blocks, compression and other filters cannot be used with contiguous data.

Chunked

The data of a dataset may be stored as fixed-size chunks. See the figure below. A chunk is a hyper-rectangle of any shape. When a dataset is chunked, each chunk is read or written as a single I/O operation, and individually passed from stage to stage of the data pipeline.

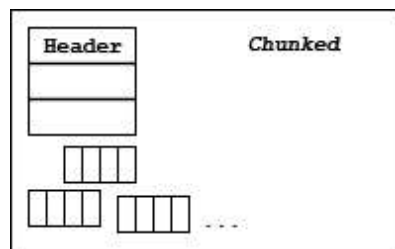

Figure 7. Chunked data storage

Chunks may be any size and shape that fits in the dataspace of the dataset. For example, a three dimensional dataspace can be chunked as 3-D cubes, 2-D planes, or 1-D lines. The chunks may extend beyond the size of the dataspace. For example, a 3 x 3 dataset might be chunked in 2 x 2 chunks. Sufficient chunks will be allocated to store the array, and any extra space will not be accessible. So, to store the 3 x 3 array, four 2 x 2 chunks would be allocated with 5 unused elements stored.

Chunked datasets can be unlimited in any direction and can be compressed or filtered.

Since the data is read or written by chunks, chunking can have a dramatic effect on performance by optimizing what is read and written. Note, too, that for specific access patterns such as parallel I/O, decomposition into chunks can have a large impact on performance.

Two restrictions have been placed on chunk shape and size:

- The rank of a chunk must be less than or equal to the rank of the dataset
- Chunk size cannot exceed the size of a fixed-size dataset; for example, a dataset consisting of a 5 x 4 fixed-size array cannot be defined with 10 x 10 chunks

Compact

For contiguous and chunked storage, the dataset header information and data are stored in two (or more) blocks. Therefore, at least two I/O operations are required to access the data: one to access the header, and one (or more) to access data. For a small dataset, this is considerable overhead.

A small dataset may be stored in a continuous array of bytes in the header block using the compact storage option. This dataset can be read entirely in one operation which retrieves the header and data. The dataset must fit in the header. This may vary depending on the metadata that is stored. In general, a compact dataset should be approximately 30 KB or less total size. See the figure below.

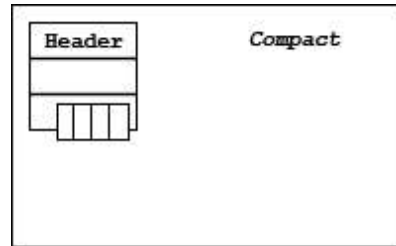

Figure 8. Compact data storage

5.4.6. Partial I/O Sub-setting and Hyperslabs

Data transfers can write or read some of the data elements of the dataset. This is controlled by specifying two selections: one for the source and one for the destination. Selections are specified by creating a dataspace with selections.

Selections may be a union of hyperslabs or a list of points. A hyperslab is a contiguous hyper-rectangle from the dataspace. Selected fields of a compound datatype may be read or written. In this case, the selection is controlled by the memory and file datatypes.

Summary of procedure:

1. Open the dataset
2. Define the memory datatype
3. Define the memory dataspace selection and file dataspace selection
4. Transfer data (H5Dread or H5Dwrite)

For a detailed explanation of selections, see the chapter “HDF5 Dataspaces and Partial I/O.”

5.5. Allocation of Space in the File

When a dataset is created, space is allocated in the file for its header and initial data. The amount of space allocated when the dataset is created depends on the storage properties. When the dataset is modified (data is written, attributes added, or other changes), additional storage may be allocated if necessary.

Table 8. Initial dataset size

Object	Size
Header	Variable, but typically around 256 bytes at the creation of a simple dataset with a simple datatype.
Data	Size of the data array (number of elements x size of element). Space allocated in the file depends on the storage strategy and the allocation strategy.

Header

A dataset header consists of one or more header messages containing persistent metadata describing various aspects of the dataset. These records are defined in the *HDF5 File Format Specification*. The amount of storage required for the metadata depends on the metadata to be stored. The table below summarizes the metadata.

Table 9. Metadata storage sizes

Header Information	Approximate Storage Size
Datatype (required)	Bytes or more. Depends on type.
Dataspace (required)	Bytes or more. Depends on number of dimensions and <code>hsize_t</code> .
Layout (required)	Points to the stored data. Bytes or more. Depends on <code>hsize_t</code> and number of dimensions.
Filters	Depends on the number of filters. The size of the filter message depends on the name and data that will be passed.

The header blocks also store the name and values of attributes, so the total storage depends on the number and size of the attributes.

In addition, the dataset must have at least one link, including a name, which is stored in the file and in the group it is linked from.

The different storage strategies determine when and how much space is allocated for the data array. See the discussion of fill values below for a detailed explanation of the storage allocation.

Contiguous Storage

For a contiguous storage option, the data is stored in a single, contiguous block in the file. The data is nominally a fixed-size, (number of elements x size of element). The figure below shows an example of a two dimensional array stored as a contiguous dataset.

Depending on the fill value properties, the space may be allocated when the dataset is created or when first written (default), and filled with fill values if specified. For parallel I/O, by default the space is allocated when the dataset is created.

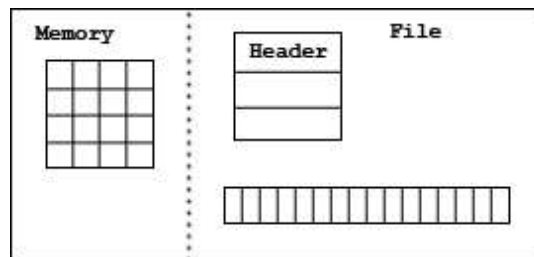

Figure 9. A two dimensional array stored as a contiguous dataset

Chunked

For chunked storage, the data is stored in one or more chunks. Each chunk is a continuous block in the file, but chunks are not necessarily stored contiguously. Each chunk has the same size. The data array has the same nominal size as a contiguous array (number of elements x size of element), but the storage is allocated in chunks, so the total size in the file can be larger than the nominal size of the array. See the figure below.

If a fill value is defined, each chunk will be filled with the fill value. Chunks must be allocated when data is written, but they may be allocated when the file is created, as the file expands, or when data is written.

For serial I/O, by default chunks are allocated incrementally, as data is written to the chunk. For a sparse dataset, chunks are allocated only for the parts of the dataset that are written. In this case, if the dataset is extended, no storage is allocated.

For parallel I/O, by default chunks are allocated when the dataset is created or extended with fill values written to the chunk.

In either case, the default can be changed using fill value properties. For example, using serial I/O, the properties can select to allocate chunks when the dataset is created.

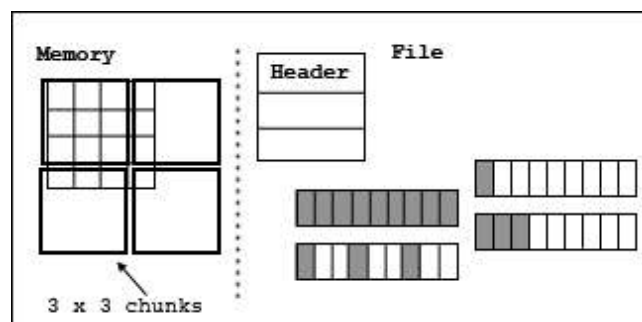

Figure 10. A two dimensional array stored in chunks

Changing Dataset Dimensions

`H5Dset_extent` is used to change the current dimensions of the dataset within the limits of the dataspace. Each dimension can be extended up to its maximum or unlimited. Extending the dataspace may or may not allocate space in the file and may or may not write fill values, if they are defined. See the example code below.

The dimensions of the dataset can also be reduced. If the sizes specified are smaller than the dataset's current dimension sizes, `H5Dset_extent` will reduce the dataset's dimension sizes to the specified values. It is the user's responsibility to ensure that valuable data is not lost; `H5Dset_extent` does not check.

```

hid_t      file_id, dataset_id;
Herr_t     status;
size_t     newdims[2];

/* Open an existing file. */
file_id = H5Fopen("dset.h5", H5F_ACC_RDWR, H5P_DEFAULT);

/* Open an existing dataset. */
dataset_id = H5Dopen(file_id, "/dset", H5P_DEFAULT);

/* Example: dataset is 2 x 3, each dimension is UNLIMITED */
/* extend to 2 x 7 */
newdims[0] = 2;
newdims[1] = 7;

status = H5Dset_extent(dataset_id, newdims);

/* dataset is now 2 x 7 */

status = H5Dclose(dataset_id);

```

Example 7. Using `H5Dset_extent` to increase the size of a dataset

5.5.1. Storage Allocation in the File: Early, Incremental, Late

The HDF5 Library implements several strategies for when storage is allocated if and when it is filled with fill values for elements not yet written by the user. Different strategies are recommended for different storage layouts and file drivers. In particular, a parallel program needs storage allocated during a collective call (for example, create or extend) while serial programs may benefit from delaying the allocation until the data is written.

Two file creation properties control when to allocate space, when to write the fill value, and the actual fill value to write.

When to Allocate Space

The table below shows the options for when data is allocated in the file. “Early” allocation is done during the dataset create call. Certain file drivers (especially MPI-I/O and MPI-POSIX) require space to be allocated when a dataset is created, so all processors will have the correct view of the data.

Table 10. File storage allocation options

Strategy	Description
Early	Allocate storage for the dataset immediately when the dataset is created.
Late	Defer allocating space for storing the dataset until the dataset is written.
Incremental	Defer allocating space for storing each chunk until the chunk is written.
Default	Use the strategy (Early, Late, or Incremental) for the storage method and access method. This is the recommended strategy.

“Late” allocation is done at the time of the first write to dataset. Space for the whole dataset is allocated at the first write.

“Incremental” allocation (chunks only) is done at the time of the first write to the chunk. Chunks that have never been written are not allocated in the file. In a sparsely populated dataset, this option allocates chunks only where data is actually written.

The “Default” property selects the option recommended as appropriate for the storage method and access method. The defaults are shown in the table below. Note that “Early” allocation is recommended for all Parallel I/O, while other options are recommended as the default for serial I/O cases.

Table 11. Default storage options

	Serial I/O	Parallel I/O
Contiguous Storage	Late	Early
Chunked Storage	Incremental	Early
Compact Storage	Early	Early

When to Write the Fill Value

The second property is when to write the fill value. The possible values are “Never” and “Allocation”. The table below shows these options.

Table 12. When to write fill values

When	Description
Never	Fill value will never be written.
Allocation	Fill value is written when space is allocated. (Default for chunked and contiguous data storage.)

Fill Values

The third property is the fill value to write. The table below shows the values. By default, the data is filled with zeroes. The application may choose no fill value (Undefined). In this case, uninitialized data may have random values. The application may define a fill value of an appropriate type. See the chapter “HDF5 Datatypes” for more information regarding fill values.

Table 13. Fill values

What to Write	Description
Default	By default, the library fills allocated space with zeroes.
Undefined	Allocated space is filled with random values.
User-defined	The application specifies the fill value.

Together these three properties control the library’s behavior. The table below summarizes the possibilities during the dataset create-write-close cycle.

Table 14. Storage allocation and fill summary

When to allocate space	When to write fill value	What fill value to write	Library create-write-close behavior
Early	Never	-	Library allocates space when dataset is created, but never writes a fill value to dataset. A read of unwritten data returns undefined values.
Late	Never	-	Library allocates space when dataset is written to, but never writes a fill value to the dataset. A read of unwritten data returns undefined values.
Incremental	Never	-	Library allocates space when a dataset or chunk (whichever is the smallest unit of space) is written to, but it never writes a fill value to a dataset or a chunk. A read of unwritten data returns undefined values.
-	Allocation	Undefined	Error on creating the dataset. The dataset is not created.
Early	Allocation	Default or User-defined	Allocate space for the dataset when the dataset is created. Write the fill value (default or user-defined) to the entire dataset when the dataset is created.
Late	Allocation	Default or User-defined	Allocate space for the dataset when the application first writes data values to the dataset. Write the fill value to the entire dataset before writing application data values.
Incremental	Allocation	Default or User-defined	Allocate space for the dataset when the application first writes data values to the dataset or chunk (whichever is the smallest unit of space). Write the fill value to the entire dataset or chunk before writing application data values.

During the `H5Dread` function call, the library behavior depends on whether space has been allocated, whether the fill value has been written to storage, how the fill value is defined, and when to write the fill value. The table below summarizes the different behaviors.

Table 15. `H5Dread` summary

Is space allocated in the file?	What is the fill value?	When to write fill value?	Library read behavior
No	Undefined	<<any>>	Error. Cannot create this dataset.
No	Default or User-defined	<<any>>	Fill the memory buffer with the fill value.
Yes	Undefined	<<any>>	Return data from storage (dataset). Trash is possible if the application has not written data to the portion of the dataset being read.
Yes	Default or User-defined	Never	Return data from storage (dataset). Trash is possible if the application has not written data to the portion of the dataset being read.
Yes	Default or User-defined	Allocation	Return data from storage (dataset).

There are two cases to consider depending on whether the space in the file has been allocated before the read or not. When space has not yet been allocated and if a fill value is defined, the memory buffer will be filled with the fill values and returned. In other words, no data has been read from the disk. If space has been allocated, the values are returned from the stored data. The unwritten elements will be filled according to the fill value.

5.5.2. Deleting a Dataset from a File and Reclaiming Space

HDF5 does not at this time provide an easy mechanism to remove a dataset from a file or to reclaim the storage space occupied by a deleted object.

Removing a dataset and reclaiming the space it used can be done with the `H5Ldelete` function and the `h5repack` utility program. With the `H5Ldelete` function, links to a dataset can be removed from the file structure. After all the links have been removed, the dataset becomes inaccessible to any application and is effectively removed from the file. The way to recover the space occupied by an unlinked dataset is to write all of the objects of the file into a new file. Any unlinked object is inaccessible to the application and will not be included in the new file. Writing objects to a new file can be done with a custom program or with the `h5repack` utility program.

See the chapter “HDF5 Groups” for further discussion of HDF5 file structures and the use of links.

5.5.3. Releasing Memory Resources

The system resources required for HDF5 objects such as datasets, datatypes, and dataspace should be released once access to the object is no longer needed. This is accomplished via the appropriate close function. This is not unique to datasets but a general requirement when working with the HDF5 Library; failure to close objects will result in resource leaks.

In the case where a dataset is created or data has been transferred, there are several objects that must be closed. These objects include datasets, datatypes, dataspace, and property lists.

The application program must free any memory variables and buffers it allocates. When accessing data from the file, the amount of memory required can be determined by calculating the size of the memory datatype and the number of elements in the memory selection.

Variable-length data are organized in two or more areas of memory. See “HDF5 Datatypes” for more information. When writing data, the application creates an array of `vl_info_t` which contains pointers to the elements. The elements might be, for example, strings. In the file, the variable-length data is stored in two parts: a heap with the variable-length values of the data elements and an array of `vl_info_t` elements. When the data is read, the amount of memory required for the heap can be determined with the `H5Dget_vlen_buf_size` call.

The data transfer property may be used to set a custom memory manager for allocating variable-length data for a `H5Dread`. This is set with the `H5Pset_vlen_mem_manager` call.

To free the memory for variable-length data, it is necessary to visit each element, free the variable-length data, and reset the element. The application must free the memory it has allocated. For memory allocated by the HDF5 Library during a read, the `H5Dvlen_reclaim` function can be used to perform this operation.

5.5.4. External Storage Properties

The external storage format allows data to be stored across a set of non-HDF5 files. A set of segments (offsets and sizes) in one or more files is defined as an external file list, or EFL, and the contiguous logical addresses of the data storage are mapped onto these segments. Currently, only the `H5D_CONTIGUOUS` storage format allows external storage. External storage is enabled by a dataset creation property. The table below shows the API.

Table 16. External storage API

Function	Description
<pre>herr_t H5Pset_external (hid_t plist, const char *name, off_t offset, hsize_t size)</pre>	<p>This function adds a new segment to the end of the external file list of the specified dataset creation property list. The segment begins a byte offset of file name and continues for size bytes. The space represented by this segment is adjacent to the space already represented by the external file list. The last segment in a file list may have the size <code>H5F_UNLIMITED</code>, in which case the external file may be of unlimited size and no more files can be added to the external files list.</p>
<pre>int H5Pget_external_count (hid_t plist)</pre>	<p>Calling this function returns the number of segments in an external file list. If the dataset creation property list has no external data, then zero is returned.</p>
<pre>herr_t H5Pget_external (hid_t plist, int idx, size_t name_size, char *name, off_t *offset, hsize_t *size)</pre>	<p>This is the counterpart for the <code>H5Pset_external()</code> function. Given a dataset creation property list and a zero-based index into that list, the file name, byte offset, and segment size are returned through non-null arguments. At most <code>name_size</code> characters are copied into the name argument which is not null terminated if the file name is longer than the supplied name buffer (this is similar to <code>strncpy()</code>).</p>

The figure below shows an example of how a contiguous, one-dimensional dataset is partitioned into three parts and each of those parts is stored in a segment of an external file. The top rectangle represents the logical address space of the dataset while the bottom rectangle represents an external file.

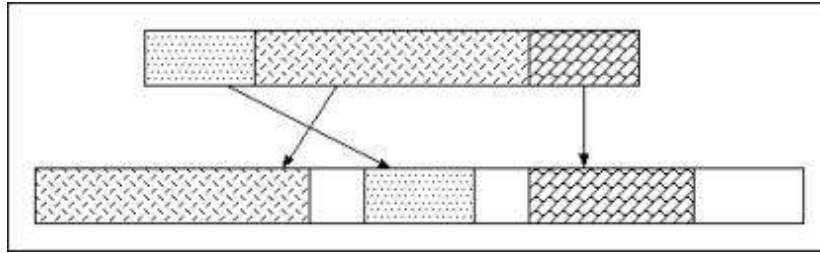

Figure 11. External file storage

The example below shows code that defines the external storage for the example. Note that the segments are defined in order of the logical addresses they represent, not their order within the external file. It would also have been possible to put the segments in separate files. Care should be taken when setting up segments in a single file since the library does not automatically check for segments that overlap.

```
Plist = H5Pcreate (H5P_DATASET_CREATE);  
H5Pset_external (plist, "velocity.data", 3000, 1000);  
H5Pset_external (plist, "velocity.data", 0, 2500);  
H5Pset_external (plist, "velocity.data", 4500, 1500);
```

Example 8. External storage

The figure below shows an example of how a contiguous, two-dimensional dataset is partitioned into three parts and each of those parts is stored in a separate external file. The top rectangle represents the logical address space of the dataset while the bottom rectangles represent external files.

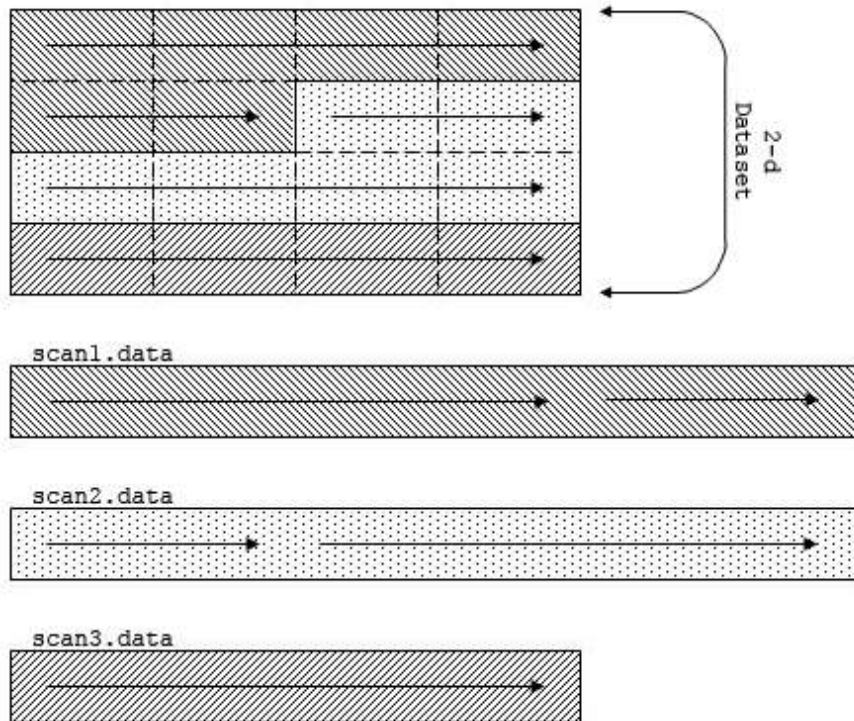

Figure 12. Partitioning a 2-D dataset for external storage

The example below shows code for the partitioning described above. In this example, the library maps the multi-dimensional array onto a linear address space as defined by the HDF5 format specification, and then maps that address space into the segments defined in the external file list.

```

Plist = H5Pcreate (H5P_DATASET_CREATE);
H5Pset_external (plist, "scan1.data", 0, 24);
H5Pset_external (plist, "scan2.data", 0, 24);
H5Pset_external (plist, "scan3.data", 0, 16);

```

Example 9. Partitioning a 2-D dataset for external storage

The segments of an external file can exist beyond the end of the (external) file. The library reads that part of a segment as zeros. When writing to a segment that exists beyond the end of a file, the external file is automatically extended. Using this feature, one can create a segment (or set of segments) which is larger than the current size of the dataset. This allows the dataset to be extended at a future time (provided the dataspace also allows the extension).

All referenced external data files must exist before performing raw data I/O on the dataset. This is normally not a problem since those files are being managed directly by the application or indirectly through some other library. However, if the file is transferred from its original context, care must be taken to assure that all the external files are accessible in the new location.

5.6. Using HDF5 Filters

This section describes in detail how to use the n-bit and scale-offset filters. Note that these filters have not yet been implemented in Fortran.

5.6.1. The N-bit Filter

N-bit data has n significant bits, where n may not correspond to a precise number of bytes. On the other hand, computing systems and applications universally, or nearly so, run most efficiently when manipulating data as whole bytes or multiple bytes.

Consider the case of 12-bit integer data. In memory, that data will be handled in at least 2 bytes, or 16 bits, and on some platforms in 4 or even 8 bytes. The size of such a dataset can be significantly reduced when written to disk if the unused bits are stripped out.

The *n-bit filter* is provided for this purpose, *packing* n-bit data on output by stripping off all unused bits and *unpacking* on input, restoring the extra bits required by the computational processor.

N-bit Datatype

An *n-bit datatype* is a datatype of n significant bits. Unless it is packed, an n -bit datatype is presented as an n -bit bitfield within a larger-sized value. For example, a 12-bit datatype might be presented as a 12-bit field in a 16-bit, or 2-byte, value.

Currently, the datatype classes of n-bit datatype or n-bit field of a compound datatype or an array datatype are limited to integer or floating-point.

The HDF5 user can create an n-bit datatype through a series of of function calls. For example, the following calls create a 16-bit datatype that is stored in a 32-bit value with a 4-bit offset:

```
hid_t nbit_datatype = H5Tcopy(H5T_STD_I32LE);
H5Tset_precision(nbit_datatype, 16);
H5Tset_offset(nbit_datatype, 4);
```

In memory, one value of the above example n-bit datatype would be stored on a little-endian machine as follows:

byte 3	byte 2	byte 1	byte 0
????????	????SPPP	PPPPPPPP	PPPP????

Key: S - sign bit, P - significant bit, ? - padding bit
Sign bit is included in signed integer datatype precision.

N-bit Filter

When data of an n-bit datatype is stored on disk using the n-bit filter, the filter *packs* the data by stripping off the padding bits; only the significant bits are retained and stored. The values on disk will appear as follows:

1st value	2nd value	
SPPPPPPP PPPPPPPP	SPPPPPPP PPPPPPPP	...

Key: S - sign bit, P - significant bit, ? - padding bit
Sign bit is included in signed integer datatype precision.

The n-bit filter can be used effectively for compressing data of an n-bit datatype, including arrays and the n-bit fields of compound datatypes. The filter supports complex situations where a compound datatype contains member(s) of a compound datatype or an array datatype has a compound datatype as the base type.

At present, the n-bit filter supports all datatypes. For datatypes of class time, string, opaque, reference, ENUM, and variable-length, the n-bit filter acts as a no-op which is short for no operation. For convenience, the rest of this section refers to such datatypes as *no-op datatypes*.

As is the case with all HDF5 filters, an application using the n-bit filter must store data with chunked storage.

How Does the N-bit Filter Work?

The n-bit filter always compresses and decompresses according to dataset properties supplied by the HDF5 Library in the datatype, dataspace, or dataset creation property list.

The dataset datatype refers to how data is stored in an HDF5 file while the memory datatype refers to how data is stored in memory. The HDF5 Library will do datatype conversion when writing data in memory to the dataset or reading data from the dataset to memory if the memory datatype differs from the dataset datatype. Datatype conversion is performed by HDF5 Library before n-bit compression and after n-bit decompression.

The following sub-sections examine the common cases:

- N-bit integer conversions
- N-bit floating-point conversions

N-bit Integer Conversions

Integer data with a dataset of integer datatype of less than full precision and a memory datatype of `H5T_NATIVE_INT`, provides the simplest application of the n-bit filter.

The precision of `H5T_NATIVE_INT` is 8 multiplied by `sizeof(int)`. This value, the size of an `int` in bytes, differs from platform to platform; we assume a value of 4 for the following illustration. We further assume the memory byte order to be little-endian.

In memory, therefore, the precision of `H5T_NATIVE_INT` is 32 and the offset is 0. One value of `H5T_NATIVE_INT` is laid out in memory as follows:

```
| byte 3 | byte 2 | byte 1 | byte 0 |
| SPPPPPPP| PPPPPPPP| PPPPPPPP| PPPPPPPP |
```

Key: S - sign bit, P - significant bit, ? - padding bit
Sign bit is included in signed integer datatype precision.

Suppose the dataset datatype has a precision of 16 and an offset of 4. After HDF5 converts values from the memory datatype to the dataset datatype, it passes something like the following to the n-bit filter for compression:

```
| byte 3 | byte 2 | byte 1 | byte 0 |
| ????????| ???S| PPP| PPPPPPPP| PPPP| ??? |
|-----|
| truncated bits
```

Key: S - sign bit, P - significant bit, ? - padding bit
Sign bit is included in signed integer datatype precision.

Notice that only the specified 16 bits (15 significant bits and the sign bit) are retained in the conversion. All other significant bits of the memory datatype are discarded because the dataset datatype calls for only 16 bits of precision. After n-bit compression, none of these discarded bits, known as *padding bits* will be stored on disk.

N-bit Floating-point Conversions

Things get more complicated in the case of a floating-point dataset datatype class. This sub-section provides an example that illustrates the conversion from a memory datatype of `H5T_NATIVE_FLOAT` to a dataset datatype of class floating-point.

As before, let the `H5T_NATIVE_FLOAT` be 4 bytes long, and let the memory byte order be little-endian. Per the IEEE standard, one value of `H5T_NATIVE_FLOAT` is laid out in memory as follows:

```
| byte 3 | byte 2 | byte 1 | byte 0 |
| SEEEEEEE| EMMMMMMM| MMMMMMMM| MMMMMMMM |
```

Key: S - sign bit, E - exponent bit, M - mantissa bit, ? - padding bit
Sign bit is included in floating-point datatype precision.

Suppose the dataset datatype has a precision of 20, offset of 7, mantissa size of 13, mantissa position of 7, exponent size of 6, exponent position of 20, and sign position of 26. (See “Definition of Datatypes,” section 4.3 of the “Datatypes” chapter in the *HDF5 User’s Guide* for a discussion of creating and modifying datatypes.)

After HDF5 converts values from the memory datatype to the dataset datatype, it passes something like the following to the n-bit filter for compression:

```
| byte 3 | byte 2 | byte 1 | byte 0 |
|         |         |         |         |
```

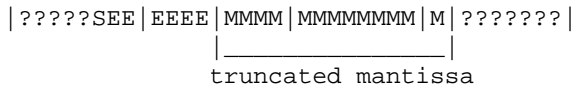

Key: S - sign bit, E - exponent bit, M - mantissa bit, ? - padding bit
Sign bit is included in floating-point datatype precision.

The sign bit and truncated mantissa bits are not changed during datatype conversion by the HDF5 Library. On the other hand, the conversion of the 8-bit exponent to a 6-bit exponent is a little tricky:

The bias for the new exponent in the n-bit datatype is:

$$2^{(n-1)} - 1$$

The following formula is used for this exponent conversion:

$$\text{exp8} - (2^{(8-1)} - 1) = \text{exp6} - (2^{(6-1)} - 1) = \textit{actual exponent value}$$

where exp8 is the stored decimal value as represented by the 8-bit exponent,
and exp6 is the stored decimal value as represented by the 6-bit exponent

In this example, caution must be taken to ensure that, after conversion, the actual exponent value is within the range that can be represented by a 6-bit exponent. For example, an 8-bit exponent can represent values from -127 to 128 while a 6-bit exponent can represent values only from -31 to 32.

N-bit Filter Behavior

The n-bit filter was designed to treat the incoming data byte by byte at the lowest level. The purpose was to make the n-bit filter as generic as possible so that no pointer cast related to the datatype is needed.

Bitwise operations are employed for packing and unpacking at the byte level.

Recursive function calls are used to treat compound and array datatypes.

N-bit Compression

The main idea of n-bit compression is to use a loop to compress each data element in a chunk. Depending on the datatype of each element, the n-bit filter will call one of four functions. Each of these functions performs one of the following tasks:

- Compress a data element of a no-op datatype
- Compress a data element of an atomic datatype
- Compress a data element of a compound datatype
- Compress a data element of an array datatype

No-op datatypes: The n-bit filter does not actually compress no-op datatypes. Rather, it copies the data buffer of the no-op datatype from the noncompressed buffer to the proper location in the compressed buffer; the compressed buffer has no holes. The term “compress” is used here simply to distinguish this function from the function that performs the reverse operation during decompression.

Atomic datatypes: The n-bit filter will find the bytes where significant bits are located and try to compress these bytes, one byte at a time, using a loop. At this level, the filter needs the following information:

- The byte offset of the beginning of the current data element with respect to the beginning of the input data buffer
- Datatype size, precision, offset, and byte order

The n-bit filter compresses from the most significant byte containing significant bits to the least significant byte. For big-endian data, therefore, the loop index progresses from smaller to larger while for little-endian, the loop index progresses from larger to smaller.

In the extreme case of when the n-bit datatype has full precision, this function copies the content of the entire noncompressed datatype to the compressed output buffer.

Compound datatypes: The n-bit filter will compress each data member of the compound datatype. If the member datatype is of an integer or floating-point datatype, the n-bit filter will call the function described above. If the member datatype is of a no-op datatype, the filter will call the function described above. If the member datatype is of a compound datatype, the filter will make a recursive call to itself. If the member datatype is of an array datatype, the filter will call the function described below

Array datatypes: The n-bit filter will use a loop to compress each array element in the array. If the base datatype of array element is of an integer or floating-point datatype, the n-bit filter will call the function described above. If the base datatype is of a no-op datatype, the filter will call the function described above. If the base datatype is of a compound datatype, the filter will call the function described above. If the member datatype is of an array datatype, the filter will make a recursive call of itself.

N-bit Decompression

The n-bit decompression algorithm is very similar to n-bit compression. The only difference is that at the byte level, compression packs out all padding bits and stores only significant bits into a continuous buffer (unsigned char) while decompression unpacks significant bits and inserts padding bits (zeros) at the proper positions to recover the data bytes as they existed before compression.

Storing N-bit Parameters to Array `cd_value[]`

All of the information, or parameters, required by the n-bit filter are gathered and stored in the array `cd_values[]` by the private function `H5Z_set_local_nbit` and are passed to another private function, `H5Z_filter_nbit`, by the HDF5 Library.

These parameters are as follows:

1. Parameters related to the datatype
2. The number of elements within the chunk
3. A flag indicating whether compression is needed

The first and second parameters can be obtained using the HDF5 dataspace and datatype interface calls.

A compound datatype can have members of array or compound datatype. An array datatype's base datatype can be a complex compound datatype. Recursive calls are required to set parameters for these complex situations.

Before setting the parameters, the number of parameters should be calculated to dynamically allocate the array

`cd_values[]`, which will be passed to the HDF5 Library. This also requires recursive calls.

For an atomic datatype (integer or floating-point), parameters that will be stored include the datatype's size, endianness, precision, and offset.

For a no-op datatype, only the size is required.

For a compound datatype, parameters that will be stored include the datatype's total size and number of members. For each member, its member offset needs to be stored. Other parameters for members will depend on the respective datatype class.

For an array datatype, the total size parameter should be stored. Other parameters for the array's base type depend on the base type's datatype class.

Further, to correctly retrieve the parameter for use of n-bit compression or decompression later, parameters for distinguishing between datatype classes should be stored.

Implementation

Three filter callback functions were written for the n-bit filter:

- `H5Z_can_apply_nbit`
- `H5Z_set_local_nbit`
- `H5Z_filter_nbit`

These functions are called internally by the HDF5 Library. A number of utility functions were written for the function `H5Z_set_local_nbit`. Compression and decompression functions were written and are called by function `H5Z_filter_nbit`. All these functions are included in the file `H5Znbit.c`.

The public function `H5Pset_nbit` is called by the application to set up the use of the n-bit filter. This function is included in the file `H5Pdcpl.c`. The application does not need to supply any parameters.

How N-bit Parameters are Stored

A scheme of storing parameters required by the n-bit filter in the array `cd_values[]` was developed utilizing recursive function calls.

Four private utility functions were written for storing the parameters associated with atomic (integer or floating-point), no-op, array, and compound datatypes:

- `H5Z_set_parms_atomic`
- `H5Z_set_parms_array`
- `H5Z_set_parms_nooptype`
- `H5Z_set_parms_compound`

The scheme is briefly described below.

First, assign a numeric code for datatype class atomic (integer or float), no-op, array, and compound datatype. The code is stored before other datatype related parameters are stored.

The first three parameters of `cd_values[]` are reserved for:

1. The number of valid entries in the array `cd_values[]`
2. A flag indicating whether compression is needed
3. The number of elements in the chunk

Throughout the balance of this explanation, `i` represents the index of `cd_values[]`.

In the function `H5Z_set_local_nbit`:

1. `i = 2`
2. Get the number of elements in the chunk and store in `cd_value[i]`; increment `i`
3. Get the class of the datatype:
 - For an integer or floating-point datatype, call `H5Z_set_parms_atomic`
 - For an array datatype, call `H5Z_set_parms_array`
 - For a compound datatype, call `H5Z_set_parms_compound`
 - For none of the above, call `H5Z_set_parms_noopdatatype`
4. Store `i` in `cd_value[0]` and flag in `cd_values[1]`

In the function `H5Z_set_parms_atomic`:

1. Store the assigned numeric code for the atomic datatype in `cd_value[i]`; increment `i`
2. Get the size of the atomic datatype and store in `cd_value[i]`; increment `i`
3. Get the order of the atomic datatype and store in `cd_value[i]`; increment `i`
4. Get the precision of the atomic datatype and store in `cd_value[i]`; increment `i`
5. Get the offset of the atomic datatype and store in `cd_value[i]`; increment `i`
6. Determine the need to do compression at this point

In the function `H5Z_set_parms_nooptype`:

1. Store the assigned numeric code for the no-op datatype in `cd_value[i]`; increment `i`
2. Get the size of the no-op datatype and store in `cd_value[i]`; increment `i`

In the function `H5Z_set_parms_array`:

1. Store the assigned numeric code for the array datatype in `cd_value[i]`; increment `i`
2. Get the size of the array datatype and store in `cd_value[i]`; increment `i`
3. Get the class of the array's base datatype.
 - For an integer or floating-point datatype, call `H5Z_set_parms_atomic`
 - For an array datatype, call `H5Z_set_parms_array`
 - For a compound datatype, call `H5Z_set_parms_compound`
 - If none of the above, call `H5Z_set_parms_noopdatatype`

In the function `H5Z_set_parms_compound`:

1. Store the assigned numeric code for the compound datatype in `cd_value[i]`; increment `i`
2. Get the size of the compound datatype and store in `cd_value[i]`; increment `i`
3. Get the number of members and store in `cd_values[i]`; increment `i`
4. For each member
 - Get the member offset and store in `cd_values[i]`; increment `i`
 - Get the class of the member datatype
 - For an integer or floating-point datatype, call `H5Z_set_parms_atomic`
 - For an array datatype, call `H5Z_set_parms_array`
 - For a compound datatype, call `H5Z_set_parms_compound`
 - If none of the above, call `H5Z_set_parms_noopdatatype`

N-bit Compression and Decompression Functions

The n-bit compression and decompression functions above are called by the private HDF5 function `H5Z_filter_nbit`. The `compress` and `decompress` functions retrieve the n-bit parameters from `cd_values[]` as it was passed by `H5Z_filter_nbit`. Parameters are retrieved in exactly the same order in which they are stored and lower-level compression and decompression functions for different datatype classes are called.

N-bit compression is not implemented in place. Due to the difficulty of calculating actual output buffer size after compression, the same space as that of the input buffer is allocated for the output buffer as passed to the compression function. However, the size of the output buffer passed by reference to the compression function will be changed (smaller) after the compression is complete.

Usage Examples

The following code example illustrates the use of the n-bit filter for writing and reading n-bit integer data.

```
#include "hdf5.h"
#include "stdlib.h"
#include "math.h"
#define H5FILE_NAME "nbit_test_int.h5"
#define DATASET_NAME "nbit_int"
#define NX 200
#define NY 300
#define CH_NX 10
#define CH_NY 15

int main(void)
{
    hid_t    file, dataspace, dataset, datatype, mem_datatype, dset_create_props;
    hsize_t  dims[2], chunk_size[2];
    int      orig_data[NX][NY];
    int      new_data[NX][NY];
    int      i, j;
    size_t   precision, offset;

    /* Define dataset datatype (integer), and set precision, offset */
    datatype = H5Tcopy(H5T_NATIVE_INT);
    precision = 17; /* precision includes sign bit */
    if(H5Tset_precision(datatype, precision) < 0) {
        printf("Error: fail to set precision\n");
        return -1;
    }
    offset = 4;
    if(H5Tset_offset(datatype, offset) < 0) {
        printf("Error: fail to set offset\n");
        return -1;
    }

    /* Copy to memory datatype */
    mem_datatype = H5Tcopy(datatype);

    /* Set order of dataset datatype */
    if(H5Tset_order(datatype, H5T_ORDER_BE) < 0) {
```

```

    printf("Error: fail to set endianness\n");
    return -1;
}

/* Initiliaze data buffer with random data within correct range
 * corresponding to the memory datatype's precision and offset.
 */
for (i=0; i < NX; i++)
    for (j=0; j < NY; j++)
        orig_data[i][j] = rand() % (int)pow(2, precision-1) <<offset;

/* Describe the size of the array. */
dims[0] = NX;
dims[1] = NY;
if((dataspace = H5Screate_simple (2, dims, NULL))<0) {
    printf("Error: fail to create dataspace\n");
    return -1;
}

/*
 * Create a new file using read/write access, default file
 * creation properties, and default file access properties.
 */
if((file = H5Fcreate (H5FILE_NAME, H5F_ACC_TRUNC,
                    H5P_DEFAULT, H5P_DEFAULT))<0) {
    printf("Error: fail to create file\n");
    return -1;
}

/*
 * Set the dataset creation property list to specify that
 * the raw data is to be partitioned into 10 x 15 element
 * chunks and that each chunk is to be compressed.
 */
chunk_size[0] = CH_NX;
chunk_size[1] = CH_NY;
if((dset_create_props = H5Pcreate (H5P_DATASET_CREATE))<0) {
    printf("Error: fail to create dataset property\n");
    return -1;
}
if(H5Pset_chunk (dset_create_props, 2, chunk_size)<0) {
    printf("Error: fail to set chunk\n");
    return -1;
}

```

```

/*
 * Set parameters for n-bit compression; check the description of
 * the H5Pset_nbit function in the HDF5 Reference Manual for more
 * information.
 */
if(H5Pset_nbit (dset_create_props)<0) {
    printf("Error: fail to set nbit filter\n");
    return -1;
}

/*
 * Create a new dataset within the file. The datatype
 * and dataspace describe the data on disk, which may
 * be different from the format used in the application's
 * memory.
 */
if((dataset = H5Dcreate(file, DATASET_NAME, datatype,
                      dataspace, H5P_DEFAULT,
                      dset_create_props, H5P_DEFAULT))<0) {
    printf("Error: fail to create dataset\n");
    return -1;
}

/*
 * Write the array to the file. The datatype and dataspace
 * describe the format of the data in the 'orig_data' buffer.
 * The raw data is translated to the format required on disk,
 * as defined above. We use default raw data transfer properties.
 */
if(H5Dwrite (dataset, mem_datatype, H5S_ALL, H5S_ALL,
            H5P_DEFAULT, orig_data)<0) {
    printf("Error: fail to write to dataset\n");
    return -1;
}

H5Dclose (dataset);

if((dataset = H5Dopen(file, DATASET_NAME, H5P_DEFAULT))<0) {
    printf("Error: fail to open dataset\n");
    return -1;
}

/*
 * Read the array. This is similar to writing data,
 * except the data flows in the opposite direction.
 * Note: Decompression is automatic.
 */
if(H5Dread (dataset, mem_datatype, H5S_ALL, H5S_ALL,
            H5P_DEFAULT, new_data)<0) {
    printf("Error: fail to read from dataset\n");
    return -1;
}

```

```
H5Tclose (datatype);
H5Tclose (mem_datatype);
H5Dclose (dataset);
H5Sclose (dataspace);
H5Pclose (dset_create_props);
H5Fclose (file);

    return 0;
}
```

Example 10. N-bit compression for integer data

Illustrates the use of the n-bit filter for writing and reading n-bit integer data.

The following code example illustrates the use of the n-bit filter for writing and reading n-bit floating-point data.

```
#include "hdf5.h"
#define H5FILE_NAME "nbit_test_float.h5"
#define DATASET_NAME "nbit_float"
#define NX 2
#define NY 5
#define CH_NX 2
#define CH_NY 5

int main(void)
{
    hid_t file, dataspace, dataset, datatype, dset_create_props;
    hsize_t dims[2], chunk_size[2];
    /* orig_data[] are initialized to be within the range that can be
     * represented by dataset datatype (no precision loss during
     * datatype conversion)
     */
    float orig_data[NX][NY] = {{188384.00, 19.103516, -1.0831790e9,
    -84.242188, 5.2045898}, {-49140.000, 2350.2500, -3.2110596e-1,
    6.4998865e-5, -0.0000000}};
    float new_data[NX][NY];
    size_t precision, offset;

    /* Define single-precision floating-point type for dataset
     *-----
     * size=4 byte, precision=20 bits, offset=7 bits,
     * mantissa size=13 bits, mantissa position=7,
     * exponent size=6 bits, exponent position=20,
     * exponent bias=31.
     * It can be illustrated in little-endian order as:
     * (S - sign bit, E - exponent bit, M - mantissa bit,
     * ? - padding bit)
     *
     *      3      2      1      0
     *      ?????SEE EEEEEMMMM MMMMMMMM M???????
     *
     * To create a new floating-point type, the following
     * properties must be set in the order of
     * set fields -> set offset -> set precision -> set size.
     * All these properties must be set before the type can function.
     * Other properties can be set anytime. Derived type size cannot
     * be expanded bigger than original size but can be decreased.
     * There should be no holes among the significant bits. Exponent
     * bias usually is set 2^(n-1)-1, where n is the exponent size.
     *-----*/
    datatype = H5Tcopy(H5T_IEEE_F32BE);
    if(H5Tset_fields(datatype, 26, 20, 6, 7, 13)<0) {
        printf("Error: fail to set fields\n");
        return -1;
    }
    offset = 7;
    if(H5Tset_offset(datatype,offset)<0) {
        printf("Error: fail to set offset\n");
        return -1;
    }
    precision = 20;
}
```



```

    if(H5Tset_precision(datatype,precision)<0) {
        printf("Error: fail to set precision\n");
        return -1;
    }
    if(H5Tset_size(datatype, 4)<0) {
        printf("Error: fail to set size\n");
        return -1;
    }
    if(H5Tset_ebias(datatype, 31)<0) {
        printf("Error: fail to set exponent bias\n");
        return -1;
    }

    /* Describe the size of the array. */
    dims[0] = NX;
    dims[1] = NY;
    if((dataspace = H5Screate_simple (2, dims, NULL))<0) {
        printf("Error: fail to create dataspace\n");
        return -1;
    }

    /*
    * Create a new file using read/write access, default file
    * creation properties, and default file access properties.
    */
    if((file = H5Fcreate (H5FILE_NAME, H5F_ACC_TRUNC,
                        H5P_DEFAULT, H5P_DEFAULT))<0) {
        printf("Error: fail to create file\n");
        return -1;
    }

    /*
    * Set the dataset creation property list to specify that
    * the raw data is to be partitioned into 2 x 5 element
    * chunks and that each chunk is to be compressed.
    */
    chunk_size[0] = CH_NX;
    chunk_size[1] = CH_NY;
    if((dset_create_props = H5Pcreate (H5P_DATASET_CREATE))<0) {
        printf("Error: fail to create dataset property\n");
        return -1;
    }
    if(H5Pset_chunk (dset_create_props, 2, chunk_size)<0) {
        printf("Error: fail to set chunk\n");
        return -1;
    }

    /*
    * Set parameters for n-bit compression; check the description
    * of the H5Pset_nbit function in the HDF5 Reference Manual
    * for more information.
    */
    if(H5Pset_nbit (dset_create_props)<0) {
        printf("Error: fail to set nbit filter\n");
        return -1;
    }

```

```

/*
 * Create a new dataset within the file.  The datatype
 * and dataspace describe the data on disk, which may
 * be different from the format used in the application's
 * memory.
 */
if((dataset = H5Dcreate(file, DATASET_NAME, datatype,
                      dataspace, H5P_DEFAULT,
                      dset_create_plists, H5P_DEFAULT))<0) {
    printf("Error: fail to create dataset\n");
    return -1;
}

/*
 * Write the array to the file.  The datatype and dataspace
 * describe the format of the data in the 'orig_data' buffer.
 * The raw data is translated to the format required on disk,
 * as defined above.  We use default raw data transfer properties.
 */
if(H5Dwrite (dataset, H5T_NATIVE_FLOAT, H5S_ALL, H5S_ALL,
            H5P_DEFAULT, orig_data)<0) {
    printf("Error: fail to write to dataset\n");
    return -1;
}

H5Dclose (dataset);

if((dataset = H5Dopen(file, DATASET_NAME, H5P_DEFAULT))<0) {
    printf("Error: fail to open dataset\n");
    return -1;
}

/*
 * Read the array.  This is similar to writing data,
 * except the data flows in the opposite direction.
 * Note: Decompression is automatic.
 */
if(H5Dread (dataset, H5T_NATIVE_FLOAT, H5S_ALL, H5S_ALL,
            H5P_DEFAULT, new_data)<0) {
    printf("Error: fail to read from dataset\n");
    return -1;
}

H5Tclose (datatype);
H5Dclose (dataset);
H5Sclose (dataspace);
H5Pclose (dset_create_props);
H5Fclose (file);

return 0;
}

```

Example 11. N-bit compression for floating-point data

Illustrates the use of the n-bit filter for writing and reading n-bit floating-point data.

Limitations

Because the array `cd_values[]` has to fit into an object header message of 64K, the n-bit filter has an upper limit on the number of n-bit parameters that can be stored in it. To be conservative, a maximum of 4K is allowed for the number of parameters.

The n-bit filter currently only compresses n-bit datatypes or fields derived from integer or floating-point datatypes. The n-bit filter assumes padding bits of zero. This may not be true since the HDF5 user can set padding bit to be zero, one, or leave the background alone. However, it is expected the n-bit filter will be modified to adjust to such situations.

The n-bit filter does not have a way to handle the situation where the fill value of a dataset is defined and the fill value is not of an n-bit datatype although the dataset datatype is.

5.6.2. The Scale-offset Filter

Generally speaking, scale-offset compression performs a scale and/or offset operation on each data value and truncates the resulting value to a minimum number of bits (minimum-bits) before storing it.

The current scale-offset filter supports integer and floating-point datatypes only. For the floating-point datatype, float and double are supported, but long double is not supported.

Integer data compression uses a straight-forward algorithm. Floating-point data compression adopts the GRiB data packing mechanism which offers two alternate methods: a fixed minimum-bits method, and a variable minimum-bits method. Currently, only the variable minimum-bits method is implemented.

Like other I/O filters supported by the HDF5 Library, applications using the scale-offset filter must store data with chunked storage.

Integer type: The minimum-bits of integer data can be determined by the filter. For example, if the maximum value of data to be compressed is 7065 and the minimum value is 2970. Then the “span” of dataset values is equal to $(\max - \min + 1)$, which is 4676. If no fill value is defined for the dataset, the minimum-bits is:

$\text{ceiling}(\log_2(\text{span})) = 12$. With fill value set, the minimum-bits is: $\text{ceiling}(\log_2(\text{span} + 1)) = 13$.

HDF5 users can also set the minimum-bits. However, if the user gives a minimum-bits that is less than that calculated by the filter, the compression will be lossy.

Floating-point type: The basic idea of the scale-offset filter for the floating-point type is to transform the data by some kind of scaling to integer data, and then to follow the procedure of the scale-offset filter for the integer type to do the data compression. Due to the data transformation from floating-point to integer, the scale-offset filter is lossy in nature.

Two methods of scaling the floating-point data are used: the so-called D-scaling and E-scaling. D-scaling is more straightforward and easy to understand. For HDF5 1.8 release, only the D-scaling method has been implemented.

Design

Before the filter does any real work, it needs to gather some information from the HDF5 Library through API calls. The parameters the filter needs are:

- The minimum-bits of the data value
- The number of data elements in the chunk
- The datatype class, size, sign (only for integer type), byte order, and fill value if defined

Size and sign are needed to determine what kind of pointer cast to use when retrieving values from the data buffer.

The pipeline of the filter can be divided into four parts: (1)pre-compression; (2)compression; (3)decompression; (4)post-decompression.

Depending on whether a fill value is defined or not, the filter will handle pre-compression and post-decompression differently.

The scale-offset filter only needs the memory byte order, size of datatype, and minimum-bits for compression and decompression.

Since decompression has no access to the original data, the minimum-bits and the minimum value need to be stored with the compressed data for decompression and post-decompression.

Integer Type

Pre-compression: During pre-compression minimum-bits is calculated if it is not set by the user. For more information on how minimum-bits are calculated, see section 6.1. “The N-bit Filter.”

If the fill value is defined, finding the maximum and minimum values should ignore the data element whose value is equal to the fill value.

If no fill value is defined, the value of each data element is subtracted by the minimum value during this stage.

If the fill value is defined, the fill value is assigned to the maximum value. In this way minimum-bits can represent a data element whose value is equal to the fill value and subtracts the minimum value from a data element whose value is not equal to the fill value.

The fill value (if defined), the number of elements in a chunk, the class of the datatype, the size of the datatype, the memory order of the datatype, and other similar elements will be stored in the HDF5 object header for the post-decompression usage.

After pre-compression, all values are non-negative and are within the range that can be stored by minimum-bits.

Compression: All modified data values after pre-compression are packed together into the compressed data buffer. The number of bits for each data value decreases from the number of bits of integer (32 for most platforms) to minimum-bits. The value of minimum-bits and the minimum value are added to the data buffer and the whole buffer is sent back to the library. In this way, the number of bits for each modified value is no more than the size of minimum-bits.

Decompression: In this stage, the number of bits for each data value is resumed from minimum-bits to the number of bits of integer.

Post-decompression: For the post-decompression stage, the filter does the opposite of what it does during pre-compression except that it does not calculate the minimum-bits or the minimum value. These values were saved during compression and can be retrieved through the resumed data buffer. If no fill value is defined, the filter adds the minimum value back to each data element.

If the fill value is defined, the filter assigns the fill value to the data element whose value is equal to the maximum value that minimum-bits can represent and adds the minimum value back to each data element whose value is not equal to the maximum value that minimum-bits can represent.

Floating-point Type

The filter will do data transformation from floating-point type to integer type and then handle the data by using the procedure for handling the integer data inside the filter. Insignificant bits of floating-point data will be cut off

during data transformation, so this filter is a lossy compression method.

There are two scaling methods: D-scaling and E-scaling. The HDF5 1.8 release only supports D-scaling. D-scaling is short for decimal scaling. E-scaling should be similar conceptually. In order to transform data from floating-point to integer, a scale factor is introduced. The minimum value will be calculated. Each data element value will subtract the minimum value. The modified data will be multiplied by 10 (Decimal) to the power of `scale_factor`, and only the integer part will be kept and manipulated through the routines for the integer type of the filter during pre-compression and compression. Integer data will be divided by 10 to the power of `scale_factor` to transform back to floating-point data during decompression and post-decompression. Each data element value will then add the minimum value, and the floating-point data are resumed. However, the resumed data will lose some insignificant bits compared with the original value.

For example, the following floating-point data are manipulated by the filter, and the D-scaling factor is 2.

```
{104.561, 99.459, 100.545, 105.644}
```

The minimum value is 99.459, each data element subtracts 99.459, the modified data is

```
{5.102, 0, 1.086, 6.185}
```

Since the D-scaling factor is 2, all floating-point data will be multiplied by 10^2 with this result:

```
{510.2, 0, 108.6, 618.5}
```

The digit after decimal point will be rounded off, and then the set looks like:

```
{510 , 0, 109, 619}
```

After decompression, each value will be divided by 10^2 and will be added to the offset 99.459.

The floating-point data becomes

```
{104.559, 99.459, 100.549, 105.649}.
```

The relative error for each value should be no more than $5 * (10^{(D\text{-scaling factor} + 1)})$. D-scaling sometimes is also referred as a variable minimum-bits method since for different datasets the minimum-bits to represent the same decimal precision will vary. The data value is modified to 2 to power of `scale_factor` for E-scaling. E-scaling is also called fixed-bits method since for different datasets the minimum-bits will always be fixed to the scale factor of E-scaling. Currently HDF5 ONLY supports D-scaling (variable minimum-bits) method.

Implementation

The scale-offset filter implementation was written and included in the file `H5Zscaleoffset.c`. Function `H5Pset_scaleoffset` was written and included in the file "`H5Pdcpl.c`". The HDF5 user can supply minimum-bits by calling function `H5Pset_scaleoffset`.

The scale-offset filter was implemented based on the design outlined in this section. However, the following factors need to be considered:

1. The filter needs the appropriate cast pointer whenever it needs to retrieve data values.
2. The HDF5 Library passes to the filter the to-be-compressed data in the format of the dataset datatype, and the filter passes back the decompressed data in the same format. If a fill value is defined, it is also in dataset datatype format. For example, if the byte order of the dataset datatype is different from that of the memory datatype of the platform, compression or decompression performs an endianness conversion of data buffer. Moreover, it should be aware that memory byte order can be different during compression and decompression.
3. The difference of endianness and datatype between file and memory should be considered when saving and retrieval of minimum-bits, minimum value, and fill value.
4. If the user sets the minimum-bits to full precision of the datatype, no operation is needed at the filter side. If the full precision is a result of calculation by the filter, then the minimum-bits needs to be saved for decompression but no compression or decompression is needed (only a copy of the input buffer is needed).
5. If by calculation of the filter, the minimum-bits is equal to zero, special handling is needed. Since it means all values are the same, no compression or decompression is needed. But the minimum-bits and minimum value still need to be saved during compression.
6. For floating-point data, the minimum value of the dataset should be calculated at first. Each data element value will then subtract the minimum value to obtain the “offset” data. The offset data will then follow the steps outlined above in the discussion of floating-point types to do data transformation to integer and rounding.

Usage Examples

The following code example illustrates the use of the scale-offset filter for writing and reading integer data.

```
#include "hdf5.h"
#include "stdlib.h"
#define H5FILE_NAME "scaleoffset_test_int.h5"
#define DATASET_NAME "scaleoffset_int"
#define NX 200
#define NY 300
#define CH_NX 10
#define CH_NY 15

int main(void)
{
    hid_t file, dataspace, dataset, datatype, dset_create_props;
    hsize_t dims[2], chunk_size[2];
    int orig_data[NX][NY];
    int new_data[NX][NY];
    int i, j, fill_val;

    /* Define dataset datatype */
    datatype = H5Tcopy(H5T_NATIVE_INT);

    /* Initialize data buffer */
    for (i=0; i < NX; i++)
        for (j=0; j < NY; j++)
            orig_data[i][j] = rand() % 10000;

    /* Describe the size of the array. */
    dims[0] = NX;
```

```

dims[1] = NY;
if((dataspace = H5Screate_simple (2, dims, NULL))<0) {
    printf("Error: fail to create dataspace\n");
    return -1;
}

/*
 * Create a new file using read/write access, default file
 * creation properties, and default file access properties.
 */
if((file = H5Fcreate (H5FILE_NAME, H5F_ACC_TRUNC,
                    H5P_DEFAULT, H5P_DEFAULT))<0) {
    printf("Error: fail to create file\n");
    return -1;
}

/*
 * Set the dataset creation property list to specify that
 * the raw data is to be partitioned into 10 x 15 element
 * chunks and that each chunk is to be compressed.
 */
chunk_size[0] = CH_NX;
chunk_size[1] = CH_NY;
if((dset_create_props = H5Pcreate (H5P_DATASET_CREATE))<0) {
    printf("Error: fail to create dataset property\n");
    return -1;
}
if(H5Pset_chunk (dset_create_props, 2, chunk_size)<0) {
    printf("Error: fail to set chunk\n");
    return -1;
}

/* Set the fill value of dataset */
fill_val = 10000;
if (H5Pset_fill_value(dset_create_props, H5T_NATIVE_INT,
                    &fill_val)<0) {
    printf("Error: can not set fill value for dataset\n");
    return -1;
}

/*
 * Set parameters for scale-offset compression. Check the
 * description of the H5Pset_scaleoffset function in the
 * HDF5 Reference Manual for more information [3].
 */
if(H5Pset_scaleoffset (dset_create_props, H5Z_SO_INT,
                    H5Z_SO_INT_MINIMUMBITS_DEFAULT)<0) {
    printf("Error: fail to set scaleoffset filter\n");
    return -1;
}

/*
 * Create a new dataset within the file. The datatype
 * and dataspace describe the data on disk, which may
 * or may not be different from the format used in the
 * application's memory. The link creation and
 * dataset access property list parameters are passed
 * with default values.
 */
if((dataset = H5Dcreate (file, DATASET_NAME, datatype,
                    dataspace, H5P_DEFAULT,

```



```

        dset_create_props, H5P_DEFAULT))<0) {
    printf("Error: fail to create dataset\n");
    return -1;
}

/*
 * Write the array to the file. The datatype and dataspace
 * describe the format of the data in the 'orig_data' buffer.
 * We use default raw data transfer properties.
 */
if(H5Dwrite (dataset, H5T_NATIVE_INT, H5S_ALL, H5S_ALL,
            H5P_DEFAULT, orig_data)<0) {
    printf("Error: fail to write to dataset\n");
    return -1;
}

H5Dclose (dataset);

if((dataset = H5Dopen(file, DATASET_NAME, H5P_DEFAULT))<0) {
    printf("Error: fail to open dataset\n");
    return -1;
}

/*
 * Read the array. This is similar to writing data,
 * except the data flows in the opposite direction.
 * Note: Decompression is automatic.
 */
if(H5Dread (dataset, H5T_NATIVE_INT, H5S_ALL, H5S_ALL,
            H5P_DEFAULT, new_data)<0) {
    printf("Error: fail to read from dataset\n");
    return -1;
}

H5Tclose (datatype);
H5Dclose (dataset);
H5Sclose (dataspace);
H5Pclose (dset_create_props);
H5Fclose (file);

return 0;
}

```

Example 12. Scale-offset compression integer data

Illustrates the use of the scale-offset filter for writing and reading integer data.

The following code example illustrates the use of the scale-offset filter (set for variable minimum-bits method) for writing and reading floating-point data.

```

#include "hdf5.h"
#include "stdlib.h"
#define H5FILE_NAME "scaleoffset_test_float_Dscale.h5"
#define DATASET_NAME "scaleoffset_float_Dscale"
#define NX 200
#define NY 300
#define CH_NX 10
#define CH_NY 15

int main(void)
{
    hid_t    file, dataspace, dataset, datatype, dset_create_props;
    hsize_t  dims[2], chunk_size[2];
    float    orig_data[NX][NY];
    float    new_data[NX][NY];
    float    fill_val;
    int      i, j;

    /* Define dataset datatype */
    datatype = H5Tcopy(H5T_NATIVE_FLOAT);

    /* Initialize data buffer */
    for (i=0; i < NX; i++)
        for (j=0; j < NY; j++)
            orig_data[i][j] = (rand() % 10000) / 1000.0;

    /* Describe the size of the array. */
    dims[0] = NX;
    dims[1] = NY;
    if((dataspace = H5Screate_simple (2, dims, NULL))<0) {
        printf("Error: fail to create dataspace\n");
        return -1;
    }

    /*
    * Create a new file using read/write access, default file
    * creation properties, and default file access properties.
    */
    if((file = H5Fcreate (H5FILE_NAME, H5F_ACC_TRUNC,
                        H5P_DEFAULT, H5P_DEFAULT))<0) {
        printf("Error: fail to create file\n");
        return -1;
    }

    /*
    * Set the dataset creation property list to specify that
    * the raw data is to be partitioned into 10 x 15 element
    * chunks and that each chunk is to be compressed.
    */
    chunk_size[0] = CH_NX;
    chunk_size[1] = CH_NY;
    if((dset_create_props = H5Pcreate (H5P_DATASET_CREATE))<0) {
        printf("Error: fail to create dataset property\n");
        return -1;
    }
    if(H5Pset_chunk (dset_create_props, 2, chunk_size)<0) {
        printf("Error: fail to set chunk\n");

```

```
    return -1;
}

/* Set the fill value of dataset */
fill_val = 10000.0;
if (H5Pset_fill_value(dset_create_props, H5T_NATIVE_FLOAT,
                    &fill_val)
```

Example 13. Scale-offset compression floating-point data

Illustrates the use of the scale-offset filter for writing and reading floating-point data.

Limitations

For floating-point data handling, there are some algorithmic limitations to the GRiB data packing mechanism:

1. Both the E-scaling and D-scaling methods are lossy compression
2. For the D-scaling method, since data values have been rounded to integer values (positive) before truncating to the minimum-bits, their range is limited by the maximum value that can be represented by the corresponding unsigned integer type (the same size as that of the floating-point type)

Suggestions

The following are some suggestions for using the filter for floating-point data:

1. It is better to convert the units of data so that the units are within certain common range (for example, 1200m to 1.2km)
2. If data values to be compressed are very near to zero, it is strongly recommended that the user sets the fill value away from zero (for example, a large positive number); if the user does nothing, the HDF5 Library will set the fill value to zero, and this may cause undesirable compression results
3. Users are not encouraged to use a very large decimal scale factor (e.g. 100) for the D-scaling method; this can cause the filter not to ignore the fill value when finding maximum and minimum values, and they will get a much larger minimum-bits (poor compression)

5.6.3. Using the Szzip Filter

See The HDF Group website for further information regarding the Szzip filter.

Chapter 6

HDF5 Datatypes

6.1. Introduction

6.1.1. Introduction and Definitions

An HDF5 dataset is an array of data elements, arranged according to the specifications of the dataspace. In general, a data element is the smallest addressable unit of storage in the HDF5 file. (Compound datatypes are the exception to this rule.) The HDF5 datatype defines the storage format for a single data element. See the figure below.

The model for HDF5 attributes is extremely similar to datasets: an attribute has a dataspace and a datatype, as shown in the figure below. The information in this chapter applies to both datasets and attributes.

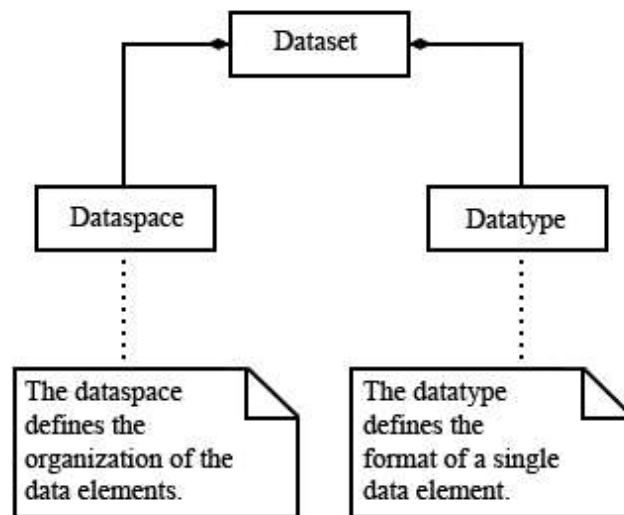

Figure 1. Datatypes, dataspace, and datasets

Abstractly, each data element within the dataset is a sequence of bits, interpreted as a single value from a set of values (e.g., a number or a character). For a given datatype, there is a standard or convention for representing the values as bits, and when the bits are represented in a particular storage the bits are laid out in a specific storage scheme, e.g., as 8-bit bytes, with a specific ordering and alignment of bytes within the storage array.

HDF5 datatypes implement a flexible, extensible, and portable mechanism for specifying and discovering the storage layout of the data elements, determining how to interpret the elements (e.g., as floating point numbers), and for transferring data from different compatible layouts.

An HDF5 datatype describes one specific layout of bits. A dataset has a single datatype which applies to every data element. When a dataset is created, the storage datatype is defined. After the dataset or attribute is created, the datatype cannot be changed.

- The datatype describes the storage layout of a single data element
- All elements of the dataset must have the same type
- The datatype of a dataset is immutable

When data is transferred (e.g., a read or write), each end point of the transfer has a datatype, which describes the correct storage for the elements. The source and destination may have different (but compatible) layouts, in which case the data elements are automatically transformed during the transfer.

HDF5 datatypes describe commonly used binary formats for numbers (integers and floating point) and characters (ASCII). A given computing architecture and programming language supports certain number and character representations. For example, a computer may support 8-, 16-, 32-, and 64-bit signed integers, stored in memory in little-endian byte order. These would presumably correspond to the C programming language types 'char', 'short', 'int', and 'long'.

When reading and writing from memory, the HDF5 library must know the appropriate datatype that describes the architecture specific layout. The HDF5 library provides the platform independent 'NATIVE' types, which are mapped to an appropriate datatype for each platform. So the type 'H5T_NATIVE_INT' is an alias for the appropriate descriptor for each platform.

Data in memory has a datatype:

- The storage layout in memory is architecture-specific
- The HDF5 'NATIVE' types are predefined aliases for the architecture-specific memory layout
- The memory datatype need not be the same as the stored datatype of the dataset

In addition to numbers and characters, an HDF5 datatype can describe more abstract classes of types, including enumerations, strings, bit strings, and references (pointers to objects in the HDF5 file). HDF5 supports several classes of composite datatypes which are combinations of one or more other datatypes. In addition to the standard predefined datatypes, users can define new datatypes within the datatype classes.

The HDF5 datatype model is very general and flexible:

- For common simple purposes, only predefined types will be needed
- Datatypes can be combined to create complex structured datatypes
- If needed, users can define custom atomic datatypes
- Committed datatypes can be shared by datasets or attributes

6.1.2. HDF5 Datatype Model

The HDF5 Library implements an object-oriented model of datatypes. HDF5 datatypes are organized as a logical set of base types, or datatype classes. Each datatype class defines a format for representing logical values as a sequence of bits. For example the `H5T_INTEGER` class is a format for representing twos complement integers of various sizes.

A datatype class is defined as a set of one or more datatype properties. A datatype property is a property of the bit string. The datatype properties are defined by the logical model of the datatype class. For example, the integer class (twos complement integers) has properties such as “signed or unsigned”, “length”, and “byte-order”. The float class (IEEE floating point numbers) has these properties, plus “exponent bits”, “exponent sign”, etc.

A datatype is derived from one datatype class: a given datatype has a specific value for the datatype properties defined by the class. For example, for 32-bit signed integers, stored big-endian, the HDF5 datatype is a sub-type of integer with the properties set to `signed=1`, `size=4` (bytes), and `byte-order=BE`.

The HDF5 datatype API (`H5T` functions) provides methods to create datatypes of different datatype classes, to set the datatype properties of a new datatype, and to discover the datatype properties of an existing datatype.

The datatype for a dataset is stored in the HDF5 file as part of the metadata for the dataset.

A datatype can be shared by more than one dataset in the file if the datatype is saved to the file with a name. This shareable datatype is known as a committed datatype. In the past, this kind of datatype was called a named datatype.

When transferring data (e.g., a read or write), the data elements of the source and destination storage must have compatible types. As a general rule, data elements with the same datatype class are compatible while elements from different datatype classes are not compatible. When transferring data of one datatype to another compatible datatype, the HDF5 Library uses the datatype properties of the source and destination to automatically transform each data element. For example, when reading from data stored as 32-bit signed integers, big-endian into 32-bit signed integers, little-endian, the HDF5 Library will automatically swap the bytes.

Thus, data transfer operations (`H5Dread`, `H5Dwrite`, `H5Aread`, `H5Awrite`) require a datatype for both the source and the destination.

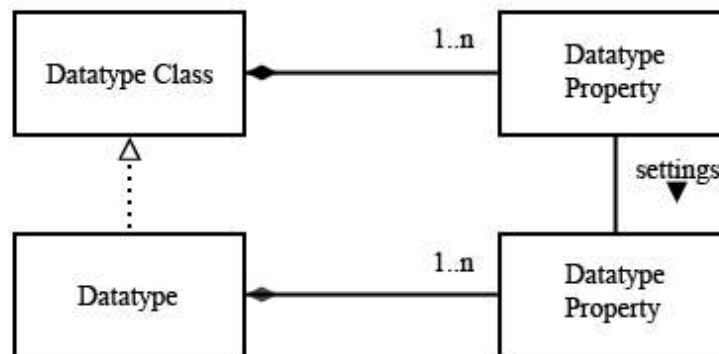

Figure 2. The datatype model

The HDF5 Library defines a set of predefined datatypes, corresponding to commonly used storage formats, such as two's complement integers, IEEE Floating point numbers, etc., 4- and 8-byte sizes, big-endian and little-endian byte orders. In addition, a user can derive types with custom values for the properties. For example, a user program may create a datatype to describe a 6-bit integer, or a 600-bit floating point number.

In addition to atomic datatypes, the HDF5 Library supports composite datatypes. A composite datatype is an aggregation of one or more datatypes. Each class of composite datatypes has properties that describe the organization of the composite datatype. See the figure below. Composite datatypes include:

- Compound datatypes: structured records
- Array: a multidimensional array of a datatype
- Variable-length: a one-dimensional array of a datatype

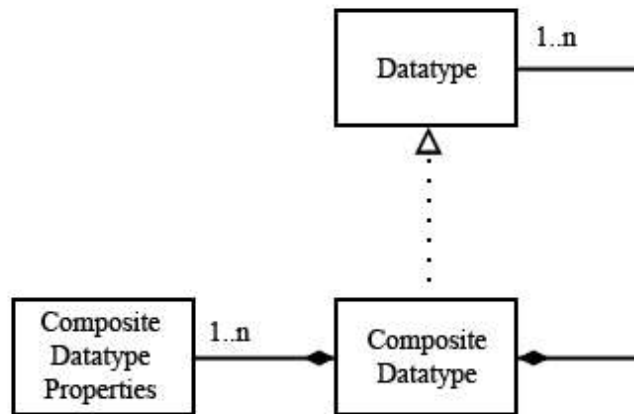

Figure 3. Composite datatypes

6.1.2.1. Datatype Classes and Properties

The figure below shows the HDF5 datatype classes. Each class is defined to have a set of properties which describe the layout of the data element and the interpretation of the bits. The table below lists the properties for the datatype classes.

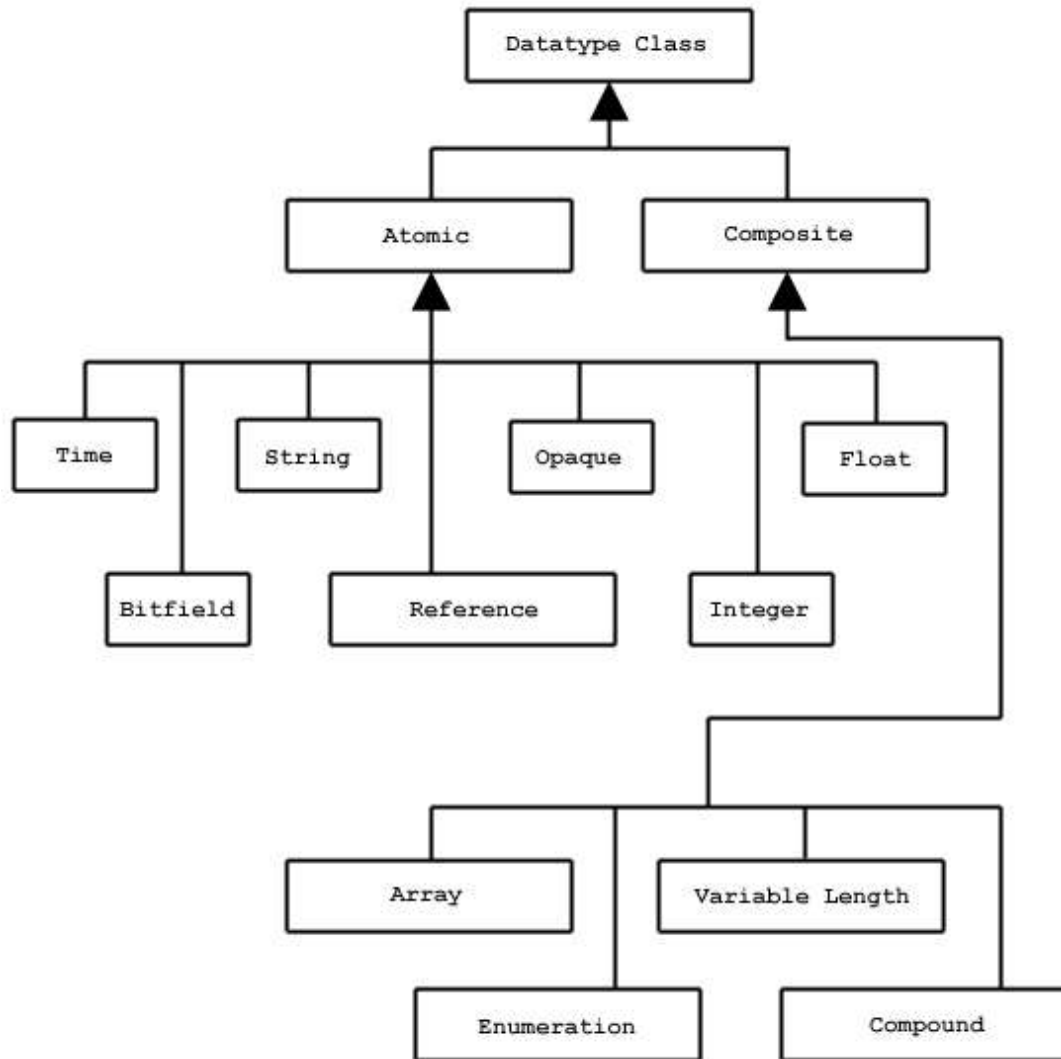

Figure 4. Datatype classes

Table 1. Datatype classes and their properties.

Class	Description	Properties	Notes
Integer	Twos complement integers	Size (bytes), precision (bits), offset (bits), pad, byte order, signed/unsigned	
Float	Floating Point numbers	Size (bytes), precision (bits), offset (bits), pad, byte order, sign position, exponent position, exponent size (bits), exponent sign, exponent bias, mantissa position, mantissa (size) bits, mantissa sign, mantissa normalization, internal padding	See IEEE 754 for a definition of these properties. These properties describe non-IEEE 754 floating point formats as well.
Character	Array of 1-byte character encoding	Size (characters), Character set, byte order, pad/no pad, pad character	Currently, ASCII and UTF-8 are supported.
Bitfield	String of bits	Size (bytes), precision (bits), offset (bits), pad, byte order	A sequence of bit values packed into one or more bytes.
Opaque	Uninterpreted data	Size (bytes), precision (bits), offset (bits), pad, byte order, tag	A sequence of bytes, stored and retrieved as a block. The 'tag' is a string that can be used to label the value.
Enumeration	A list of discrete values, with symbolic names in the form of strings.	Number of elements, element names, element values	Enumeration is a list of pairs, (name, value). The name is a string, the value is an unsigned integer.
Reference	Reference to object or region within the HDF5 file		See the Reference API, H5R
Array	Array (1-4 dimensions) of data elements	Number of dimensions, dimension sizes, base datatype	The array is accessed atomically: no selection or sub-setting.
Variable-length	A variable-length 1-dimensional array of data data elements	Current size, base type	
Compound	A Datatype of a sequence of Datatypes	Number of members, member names, member types, member offset, member class, member size, byte order	

6.1.2.2. Predefined Datatypes

The HDF5 library predefines a modest number of commonly used datatypes. These types have standard symbolic names of the form `H5T_arch_base` where *arch* is an architecture name and *base* is a programming type name (Table 2). New types can be derived from the predefined types by copying the predefined type (see `H5Tcopy()`) and then modifying the result.

The base name of most types consists of a letter to indicate the class (Table 3), a precision in bits, and an indication of the byte order (Table 4).

Table 5 shows examples of predefined datatypes. The full list can be found in the “HDF5 Predefined Datatypes” section of the *HDF5 Reference Manual*.

Table 2. Architectures used in predefined datatypes

Architecture Name	Description
IEEE	IEEE-754 standard floating point types in various byte orders.
STD	This is an architecture that contains semi-standard datatypes like signed two's complement integers, unsigned integers, and bitfields in various byte orders.
C FORTRAN	Types which are specific to the C or Fortran programming languages are defined in these architectures. For instance, <code>H5T_C_S1</code> defines a base string type with null termination which can be used to derive string types of other lengths.
NATIVE	This architecture contains C-like datatypes for the machine on which the library was compiled. The types were actually defined by running the <code>H5detect</code> program when the library was compiled. In order to be portable, applications should almost always use this architecture to describe things in memory.
CRAY	Cray architectures. These are word-addressable, big-endian systems with non-IEEE floating point.
INTEL	All Intel and compatible CPU's including 80286, 80386, 80486, Pentium, Pentium-Pro, and Pentium-II. These are little-endian systems with IEEE floating-point.
MIPS	All MIPS CPU's commonly used in SGI systems. These are big-endian systems with IEEE floating-point.
ALPHA	All DEC Alpha CPU's, little-endian systems with IEEE floating-point.

Table 3. Base types

B	Bitfield
F	Floating point
I	Signed integer
R	References
S	Character string
U	Unsigned integer

Table 4. Byte order

BE	Big-endian
LE	Little-endian

Table 5. Some predefined datatypes

Example	Description
H5T_IEEE_F64LE	Eight-byte, little-endian, IEEE floating-point
H5T_IEEE_F32BE	Four-byte, big-endian, IEEE floating point
H5T_STD_I32LE	Four-byte, little-endian, signed two's complement integer
H5T_STD_U16BE	Two-byte, big-endian, unsigned integer
H5T_C_S1	One-byte, null-terminated string of eight-bit characters
H5T_INTEL_B64	Eight-byte bit field on an Intel CPU
H5T_CRAY_F64	Eight-byte Cray floating point
H5T_STD_ROBJ	Reference to an entire object in a file

The HDF5 Library predefines a set of `NATIVE` datatypes which are similar to C type names. The native types are set to be an alias for the appropriate HDF5 datatype for each platform. For example, `H5T_NATIVE_INT` corresponds to a C `int` type. On an Intel based PC, this type is the same as `H5T_STD_I32LE`, while on a MIPS system this would be equivalent to `H5T_STD_I32BE`. Table 6 shows examples of `NATIVE` types and corresponding C types for a common 32-bit workstation.

Table 6. Native and 32-bit C datatypes

Example	Corresponding C Type
<code>H5T_NATIVE_CHAR</code>	<code>char</code>
<code>H5T_NATIVE_SCHAR</code>	signed char
<code>H5T_NATIVE_UCHAR</code>	unsigned char
<code>H5T_NATIVE_SHORT</code>	short
<code>H5T_NATIVE_USHORT</code>	unsigned short
<code>H5T_NATIVE_INT</code>	int
<code>H5T_NATIVE_UINT</code>	unsigned
<code>H5T_NATIVE_LONG</code>	long
<code>H5T_NATIVE_ULONG</code>	unsigned long
<code>H5T_NATIVE_LLONG</code>	long long
<code>H5T_NATIVE_ULLONG</code>	unsigned long long
<code>H5T_NATIVE_FLOAT</code>	float
<code>H5T_NATIVE_DOUBLE</code>	double
<code>H5T_NATIVE_LDOUBLE</code>	long double
<code>H5T_NATIVE_HSIZE</code>	<code>hsize_t</code>
<code>H5T_NATIVE_HSSIZE</code>	<code>hssize_t</code>
<code>H5T_NATIVE_HERR</code>	<code>herr_t</code>
<code>H5T_NATIVE_HBOOL</code>	<code>hbool_t</code>
<code>H5T_NATIVE_B8</code>	8-bit unsigned integer or 8-bit buffer in memory
<code>H5T_NATIVE_B16</code>	16-bit unsigned integer or 16-bit buffer in memory
<code>H5T_NATIVE_B32</code>	32-bit unsigned integer or 32-bit buffer in memory
<code>H5T_NATIVE_B64</code>	64-bit unsigned integer or 64-bit buffer in memory

6.2. How Datatypes are Used

6.2.1. The Datatype Object and the HDF5 Datatype API

The HDF5 Library manages datatypes as objects. The HDF5 datatype API manipulates the datatype objects through C function calls. New datatypes can be created from scratch or copied from existing datatypes. When a datatype is no longer needed its resources should be released by calling `H5Tclose()`.

The datatype object is used in several roles in the HDF5 data model and library. Essentially, a datatype is used whenever the format of data elements is needed. There are four major uses of datatypes in the HDF5 Library: at dataset creation, during data transfers, when discovering the contents of a file, and for specifying user-defined datatypes. See the table below.

Table 7. Datatype uses

Use	Description
Dataset creation	The datatype of the data elements must be declared when the dataset is created.
Data transfer	The datatype (format) of the data elements must be defined for both the source and destination.
Discovery	The datatype of a dataset can be interrogated to retrieve a complete description of the storage layout.
Creating user-defined datatypes	Users can define their own datatypes by creating datatype objects and setting their properties.

6.2.2. Dataset Creation

All the data elements of a dataset have the same datatype. When a dataset is created, the datatype for the data elements must be specified. The datatype of a dataset can never be changed. The example below shows the use of a datatype to create a dataset called “/dset”. In this example, the dataset will be stored as 32-bit signed integers in big-endian order.

```
hid_t dt;
dt = H5Tcopy(H5T_STD_I32BE);
dataset_id = H5Dcreate(file_id, "/dset", dt, dataspace_id,
    H5P_DEFAULT, H5P_DEFAULT, H5P_DEFAULT);
```

Example 1. Using a datatype to create a dataset

6.2.3. Data Transfer (Read and Write)

Probably the most common use of datatypes is to write or read data from a dataset or attribute. In these operations, each data element is transferred from the source to the destination (possibly rearranging the order of the elements). Since the source and destination do not need to be identical (i.e., one is disk and the other is memory) the transfer requires both the format of the source element and the destination element. Therefore, data transfers use two datatype objects, for the source and destination.

When data is written, the source is memory and the destination is disk (file). The memory datatype describes the format of the data element in the machine memory, and the file datatype describes the desired format of the data element on disk. Similarly, when reading, the source datatype describes the format of the data element on disk,

and the destination datatype describes the format in memory.

In the most common cases, the file datatype is the datatype specified when the dataset was created, and the memory datatype should be the appropriate NATIVE type.

The examples below show samples of writing data to and reading data from a dataset. The data in memory is declared C type 'int', and the datatype H5T_NATIVE_INT corresponds to this type. The datatype of the dataset should be of datatype class H5T_INTEGER.

```
int dset_data[DATA_SIZE];

status = H5Dwrite(dataset_id, H5T_NATIVE_INT, H5S_ALL, H5S_ALL,
                 H5P_DEFAULT, dset_data);
```

Example 2. Writing to a dataset

```
int dset_data[DATA_SIZE];

status = H5Dread(dataset_id, H5T_NATIVE_INT, H5S_ALL, H5S_ALL,
                 H5P_DEFAULT, dset_data);
```

Example 3. Reading from a dataset

6.2.4. Discovery of Data Format

The HDF5 Library enables a program to determine the datatype class and properties for any datatype. In order to discover the storage format of data in a dataset, the datatype is obtained, and the properties are determined by queries to the datatype object. The example below shows code that analyzes the datatype for an integer and prints out a description of its storage properties (byte order, signed, size.)

```
switch (H5Tget_class(type)) {
case H5T_INTEGER:
    ord = H5Tget_order(type);
    sgn = H5Tget_sign(type);
    printf("Integer ByteOrder= ");
    switch (ord) {
case H5T_ORDER_LE:
        printf("LE");
        break;
case H5T_ORDER_BE:
        printf("BE");
        break;
    }
    printf(" Sign= ");
    switch (sgn) {
case H5T_SGN_NONE:
        printf("false");
        break;
case H5T_SGN_2:
        printf("true");
        break;
    }
    printf(" Size= ");
    sz = H5Tget_size(type);
    printf("%d", sz);
    printf("\n");
    break;
}
```

Example 4. Discovering datatype properties

6.2.5. Creating and Using User-defined Datatypes

Most programs will primarily use the predefined datatypes described above, possibly in composite datatypes such as compound or array datatypes. However, the HDF5 datatype model is extremely general; a user program can define a great variety of atomic datatypes (storage layouts). In particular, the datatype properties can define signed and unsigned integers of any size and byte order, and floating point numbers with different formats, size, and byte order. The HDF5 datatype API provides methods to set these properties.

User-defined types can be used to define the layout of data in memory, e.g., to match some platform specific number format or application defined bit-field. The user-defined type can also describe data in the file, e.g., some application-defined format. The user-defined types can be translated to and from standard types of the same class, as described above.

6.3. Datatype (H5T) Function Summaries

Functions that can be used with datatypes (H5T functions) and property list functions that can be used with datatypes (H5P functions) are listed below.

Function Listing 1. General datatype operations

C Function	Purpose
Fortran Function	
H5Tcreate h5tcreate_f	Creates a new datatype.
H5Topen h5topen_f	Opens a committed datatype. The C function is a macro: see “API Compatibility Macros in HDF5.”
H5Tcommit h5tcommit_f	Commits a transient datatype to a file. The datatype is now a committed datatype. The C function is a macro: see “API Compatibility Macros in HDF5.”
H5Tcommit_anon h5tcommit_anon_f	Commits a transient datatype to a file. The datatype is now a committed datatype, but it is not linked into the file structure.
H5Tcommitted h5tcommitted_f	Determines whether a datatype is a committed or a transient type.
H5Tcopy h5tcopy_f	Copies an existing datatype.
H5Tequal h5tequal_f	Determines whether two datatype identifiers refer to the same datatype.
H5Tlock (none)	Locks a datatype.
H5Tget_class h5tget_class_f	Returns the datatype class identifier.
H5Tget_create_plist h5tget_create_plist_f	Returns a copy of a datatype creation property list.
H5Tget_size h5tget_size_f	Returns the size of a datatype.
H5Tget_super h5tget_super_f	Returns the base datatype from which a datatype is derived.
H5Tget_native_type h5tget_native_type_f	Returns the native datatype of a specified datatype.
H5Tdetect_class (none)	Determines whether a datatype is of the given datatype class.
H5Tget_order h5tget_order_f	Returns the byte order of a datatype.
H5Tset_order h5tset_order_f	Sets the byte ordering of a datatype.
H5Tdecode h5tdecode_f	Decode a binary object description of datatype and return a new object identifier.

H5Tencode	Encode a datatype object description into a binary buffer.
h5tencode	
H5Tclose	Releases a datatype.
h5tclose_f	

Function Listing 2. Conversion functions

C Function	Purpose
Fortran Function	
H5Tconvert	Converts data between specified datatypes.
(none)	
H5Tcompiler_conv	Check whether the library's default conversion is hard conversion.
h5tcompiler_conv_f	
H5Tfind	Finds a conversion function.
(none)	
H5Tregister	Registers a conversion function.
(none)	
H5Tunregister	Removes a conversion function from all conversion paths.
(none)	

Function Listing 3. Atomic datatype properties

C Function	Purpose
Fortran Function	
H5Tset_size	Sets the total size for an atomic datatype.
h5tset_size_f	
H5Tget_precision	Returns the precision of an atomic datatype.
h5tget_precision_f	
H5Tset_precision	Sets the precision of an atomic datatype.
h5tset_precision_f	
H5Tget_offset	Retrieves the bit offset of the first significant bit.
h5tget_offset_f	
H5Tset_offset	Sets the bit offset of the first significant bit.
h5tset_offset_f	
H5Tget_pad	Retrieves the padding type of the least and most-significant bit padding.
h5tget_pad_f	
H5Tset_pad	Sets the least and most-significant bits padding types.
h5tset_pad_f	
H5Tget_sign	Retrieves the sign type for an integer type.
h5tget_sign_f	
H5Tset_sign	Sets the sign property for an integer type.
h5tset_sign_f	
H5Tget_fields	Retrieves floating point datatype bit field information.
h5tget_fields_f	
H5Tset_fields	Sets locations and sizes of floating point bit fields.
h5tset_fields_f	

H5Tget_ebias	Retrieves the exponent bias of a floating-point type.
h5tget_ebias_f	
H5Tset_ebias	Sets the exponent bias of a floating-point type.
h5tset_ebias_f	
H5Tget_norm	Retrieves mantissa normalization of a floating-point datatype.
h5tget_norm_f	
H5Tset_norm	Sets the mantissa normalization of a floating-point datatype.
h5tset_norm_f	
H5Tget_inpad	Retrieves the internal padding type for unused bits in floating-point datatypes.
h5tget_inpad_f	
H5Tset_inpad	Fills unused internal floating point bits.
h5tset_inpad_f	
H5Tget_cset	Retrieves the character set type of a string datatype.
h5tget_cset_f	
H5Tset_cset	Sets character set to be used.
h5tset_cset_f	
H5Tget_strpad	Retrieves the storage mechanism for a string datatype.
h5tget_strpad_f	
H5Tset_strpad	Defines the storage mechanism for character strings.
h5tset_strpad_f	

Function Listing 4. Enumeration datatypes

C Function	Purpose
Fortran Function	
H5Tenum_create	Creates a new enumeration datatype.
h5tenum_create_f	
H5Tenum_insert	Inserts a new enumeration datatype member.
h5tenum_insert_f	
H5Tenum_nameof	Returns the symbol name corresponding to a specified member of an enumeration datatype.
h5tenum_nameof_f	
H5Tenum_valueof	Returns the value corresponding to a specified member of an enumeration datatype.
h5tenum_valueof_f	
H5Tget_member_value	Returns the value of an enumeration datatype member.
h5tget_member_value_f	
H5Tget_nmembers	Retrieves the number of elements in a compound or enumeration datatype.
h5tget_nmembers_f	
H5Tget_member_name	Retrieves the name of a compound or enumeration datatype member.
h5tget_member_name_f	
H5Tget_member_index	Retrieves the index of a compound or enumeration datatype member.
(none)	

Function Listing 5. Compound datatype properties

C Function	Purpose
Fortran Function	
H5Tget_nmembers h5tget_nmembers_f	Retrieves the number of elements in a compound or enumeration datatype.
H5Tget_member_class h5tget_member_class_f	Returns datatype class of compound datatype member.
H5Tget_member_name h5tget_member_name_f	Retrieves the name of a compound or enumeration datatype member.
H5Tget_member_index h5tget_member_index_f	Retrieves the index of a compound or enumeration datatype member.
H5Tget_member_offset h5tget_member_offset_f	Retrieves the offset of a field of a compound datatype.
H5Tget_member_type h5tget_member_type_f	Returns the datatype of the specified member.
H5Tinsert h5tinsert_f	Adds a new member to a compound datatype.
H5Tpack h5tpack_f	Recursively removes padding from within a compound datatype.

Function Listing 6. Array datatypes

C Function	Purpose
Fortran Function	
H5Tarray_create h5tarray_create_f	Creates an array datatype object. The C function is a macro: see “API Compatibility Macros in HDF5.”
H5Tget_array_ndims h5tget_array_ndims_f	Returns the rank of an array datatype.
H5Tget_array_dims h5tget_array_dims_f	Returns sizes of array dimensions and dimension permutations. The C function is a macro: see “API Compatibility Macros in HDF5.”

Function Listing 7. Variable-length datatypes

C Function	Purpose
Fortran Function	
H5Tvlen_create h5tvlen_create_f	Creates a new variable-length datatype.
H5Tis_variable_str h5tis_variable_str_f	Determines whether datatype is a variable-length string.

Function Listing 8. Opaque datatypes

C Function	Purpose
Fortran Function	
H5Tset_tag	Tags an opaque datatype.
h5tset_tag_f	
H5Tget_tag	Gets the tag associated with an opaque datatype.
h5tget_tag_f	

Function Listing 9. Conversions between datatype and text

C Function	Purpose
Fortran Function	
H5LTtext_to_dtype (none)	Creates a datatype from a text description.
H5LTdtype_to_text (none)	Generates a text description of a datatype.

Function Listing 10. Datatype creation property list functions (H5P)

C Function	Purpose
Fortran Function	
H5Pset_char_encoding	Sets the character encoding used to encode a string. Use to set
h5pset_char_encoding_f	ASCII or UTF-8 character encoding for object names.
H5Pget_char_encoding	Retrieves the character encoding used to create a string.
h5pget_char_encoding_f	

Function Listing 11. Datatype access property list functions (H5P)

C Function	Purpose
Fortran Function	
H5Pset_type_conv_cb (none)	Sets user-defined datatype conversion callback function.
H5Pget_type_conv_cb (none)	Gets user-defined datatype conversion callback function.

6.4. The Programming Model

6.4.1. Introduction

The HDF5 Library implements an object-oriented model of datatypes. HDF5 datatypes are organized as a logical set of base types, or datatype classes. The HDF5 Library manages datatypes as objects. The HDF5 datatype API manipulates the datatype objects through C function calls. The figure below shows the abstract view of the datatype object. The table below shows the methods (C functions) that operate on datatype objects. New datatypes can be created from scratch or copied from existing datatypes.

Datatype
size:int? byteOrder:B0type
open(hid_t loc, char *, name):return hid_t copy(hid_t tid) return hid_t create(hid_class_t cls, size_t size) return hid_t

Figure 5. The datatype object

Table 8. General operations on datatype objects

API Function	Description
hid_t H5Tcreate (H5T_class_t class, size_t size)	Create a new datatype object of datatype class <i>class</i> . The following datatype classes are supported with this function: <ul style="list-style-type: none"> • H5T_COMPOUND • H5T_OPAQUE • H5T_ENUM
hid_t H5Tcopy (hid_t type)	Other datatypes are created with H5Tcopy(). Obtain a modifiable transient datatype which is a copy of <i>type</i> . If <i>type</i> is a dataset identifier then the type returned is a modifiable transient copy of the datatype of the specified dataset.
hid_t H5Topen (hid_t location, const char *name, H5P_DEFAULT)	Open a committed datatype. The committed datatype returned by this function is read-only.
htri_t H5Tequal (hid_t type1, hid_t type2)	Determines if two types are equal.

<code>herr_t H5Tclose (hid_t type)</code>	Releases resources associated with a datatype obtained from <code>H5Tcopy</code> , <code>H5Topen</code> , or <code>H5Tcreate</code> . It is illegal to close an immutable transient datatype (e.g., predefined types).
<code>herr_t H5Tcommit (hid_t location, const char *name, hid_t type, H5P_DEFAULT, H5P_DEFAULT, H5P_DEFAULT)</code>	Commit a transient datatype (not immutable) to a file to become a committed datatype. Committed datatypes can be shared.
<code>htri_t H5Tcommitted (hid_t type)</code>	Test whether the datatype is transient or committed (named).
<code>herr_t H5Tlock (hid_t type)</code>	Make a transient datatype immutable (read-only and not closable). Predefined types are locked.

In order to use a datatype, the object must be created (`H5Tcreate`), or a reference obtained by cloning from an existing type (`H5Tcopy`), or opened (`H5Topen`). In addition, a reference to the datatype of a dataset or attribute can be obtained with `H5Dget_type` or `H5Aget_type`. For composite datatypes a reference to the datatype for members or base types can be obtained (`H5Tget_member_type`, `H5Tget_super`). When the datatype object is no longer needed, the reference is discarded with `H5Tclose`.

Two datatype objects can be tested to see if they are the same with `H5Tequal`. This function returns true if the two datatype references refer to the same datatype object. However, if two datatype objects define equivalent datatypes (the same datatype class and datatype properties), they will not be considered 'equal'.

A datatype can be written to the file as a first class object (`H5Tcommit`). This is a committed datatype and can be used in the same way as any other datatype.

6.4.2. Discovery of Datatype Properties

Any HDF5 datatype object can be queried to discover all of its datatype properties. For each datatype class, there are a set of API functions to retrieve the datatype properties for this class.

6.4.2.1. Properties of Atomic Datatypes

Table 9 lists the functions to discover the properties of atomic datatypes. Table 10 lists the queries relevant to specific numeric types. Table 11 gives the properties for atomic string datatype, and Table 12 gives the property of the opaque datatype.

Table 9. Functions to discover properties of atomic datatypes

Functions	Description
<code>H5T_class_t H5Tget_class (hid_t type)</code>	The datatype class: <code>H5T_INTEGER</code> , <code>H5T_FLOAT</code> , <code>H5T_STRING</code> , or <code>H5T_BITFIELD</code> , <code>H5T_OPAQUE</code> , <code>H5T_COMPOUND</code> , <code>H5T_REFERENCE</code> , <code>H5T_ENUM</code> , <code>H5T_VLEN</code> , <code>H5T_ARRAY</code>
<code>size_t H5Tget_size (hid_t type)</code>	The total size of the element in bytes, including padding which may appear on either side of the actual value.
<code>H5T_order_t H5Tget_order (hid_t type)</code>	The byte order describes how the bytes of the datatype are laid out in memory. If the lowest memory address contains the least significant byte of the datum then it is said to be <i>little-endian</i> or <code>H5T_ORDER_LE</code> . If the bytes are in the opposite order then they are said to be <i>big-endian</i> or <code>H5T_ORDER_BE</code> .
<code>size_t H5Tget_precision (hid_t type)</code>	The precision property identifies the number of significant bits of a datatype and the <code>offset</code> property (defined below) identifies its location. Some datatypes occupy more bytes than what is needed to store the value. For instance, a <code>short</code> on a Cray is 32 significant bits in an eight-byte field.
<code>int H5Tget_offset (hid_t type)</code>	The <code>offset</code> property defines the bit location of the least significant bit of a bit field whose length is <code>precision</code> .
<code>herr_t H5Tget_pad (hid_t type, H5T_pad_t *lsb, H5T_pad_t *msb)</code>	Padding is the bits of a data element which are not significant as defined by the <code>precision</code> and <code>offset</code> properties. Padding in the low-numbered bits is <i>lsb</i> padding and padding in the high-numbered bits is <i>msb</i> padding. Padding bits can be set to zero (<code>H5T_PAD_ZERO</code>) or one (<code>H5T_PAD_ONE</code>).

Table 10. Functions to discover properties of atomic numeric datatypes

Functions	Description
<code>H5T_sign_t H5Tget_sign (hid_t type)</code>	(INTEGER) Integer data can be signed two's complement (<code>H5T_SGN_2</code>) or unsigned (<code>H5T_SGN_NONE</code>).
<code>herr_t H5Tget_fields (hid_t type, size_t *spos, size_t *epos, size_t *esize, size_t *mpos, size_t *msize)</code>	(FLOAT) A floating-point data element has bit fields which are the exponent and mantissa as well as a mantissa sign bit. These properties define the location (bit position of least significant bit of the field) and size (in bits) of each field. The sign bit is always of length one and none of the fields are allowed to overlap.
<code>size_t H5Tget_ebias (hid_t type)</code>	(FLOAT) The exponent is stored as a non-negative value which is <code>ebias</code> larger than the true exponent.
<code>H5T_norm_t H5Tget_norm (hid_t type)</code>	<p>(FLOAT) This property describes the normalization method of the mantissa.</p> <ul style="list-style-type: none"> • <code>H5T_NORM_MSBSET</code>: the mantissa is shifted left (if non-zero) until the first bit after the radix point is set and the exponent is adjusted accordingly. All bits of the mantissa after the radix point are stored. • <code>H5T_NORM_IMPLIED</code>: the mantissa is shifted left (if non-zero) until the first bit after the radix point is set and the exponent is adjusted accordingly. The first bit after the radix point is not stored since it's always set. • <code>H5T_NORM_NONE</code>: the fractional part of the mantissa is stored without normalizing it.
<code>H5T_pad_t H5Tget_inpad (hid_t type)</code>	(FLOAT) If any internal bits (that is, bits between the sign bit, the mantissa field, and the exponent field but within the precision field) are unused, then they will be filled according to the value of this property. The padding can be: <code>H5T_PAD_NONE</code> , <code>H5T_PAD_ZERO</code> or <code>H5T_PAD_ONE</code> .

Table 11. Functions to discover properties of atomic string datatypes

Functions	Description
H5T_cset_t H5Tget_cset (hid_t type)	The only character set currently supported is H5T_CSET_ASCII.
H5T_str_t H5Tget_strpad (hid_t type)	The string datatype has a fixed length, but the string may be shorter than the length. This property defines the storage mechanism for the left over bytes. The options are: H5T_STR_NULLTERM, H5T_STR_NULLPAD, or H5T_STR_SPACEPAD.

Table 12. Functions to discover properties of atomic opaque datatypes

Functions	Description
char *H5Tget_tag(hid_t type_id)	A user-defined string.

6.4.2.2. Properties of Composite Datatypes

The composite datatype classes can also be analyzed to discover their datatype properties and the datatypes that are members or base types of the composite datatype. The member or base type can, in turn, be analyzed. The table below lists the functions that can access the datatype properties of the different composite datatypes.

Table 13. Functions to discover properties of composite datatypes

Functions	Description
<code>int H5Tget_nmembers(hid_t type_id)</code>	(COMPOUND) The number of fields in the compound datatype.
<code>H5T_class_t H5Tget_member_class (hid_t cdtype_id, unsigned member_no)</code>	(COMPOUND) The datatype class of compound datatype member <code>member_no</code> .
<code>char * H5Tget_member_name (hid_t type_id, unsigned field_idx)</code>	(COMPOUND) The name of field <code>field_idx</code> of a compound datatype.
<code>size_t H5Tget_member_offset (hid_t type_id, unsigned memb_no)</code>	(COMPOUND) The byte offset of the beginning of a field within a compound datatype.
<code>hid_t H5Tget_member_type (hid_t type_id, unsigned field_idx)</code>	(COMPOUND) The datatype of the specified member.
<code>int H5Tget_array_ndims (hid_t adtype_id)</code>	(ARRAY) The number of dimensions (rank) of the array datatype object.
<code>int H5Tget_array_dims (hid_t adtype_id, hsize_t *dims[])</code>	(ARRAY) The sizes of the dimensions and the dimension permutations of the array datatype object.
<code>hid_t H5Tget_super(hid_t type)</code>	(ARRAY, VL, ENUM) The base datatype from which the datatype type is derived.
<code>herr_t H5Tenum_nameof(hid_t type void *value, char *name, size_t size)</code>	(ENUM) The symbol name that corresponds to the specified value of the enumeration datatype
<code>herr_t H5Tenum_valueof(hid_t type char *name, void *value)</code>	(ENUM) The value that corresponds to the specified name of the enumeration datatype
<code>herr_t H5Tget_member_value (hid_t type unsigned memb_no, void *value)</code>	(ENUM) The value of the enumeration datatype member <code>memb_no</code>

6.4.3. Definition of Datatypes

The HDF5 Library enables user programs to create and modify datatypes. The essential steps are:

1. a) Create a new datatype object of a specific composite datatype class, or
b) Copy an existing atomic datatype object
2. Set properties of the datatype object
3. Use the datatype object
4. Close the datatype object

To create a user-defined atomic datatype, the procedure is to clone a predefined datatype of the appropriate datatype class (`H5Tcopy`), and then set the datatype properties appropriate to the datatype class. The table below shows how to create a datatype to describe a 1024-bit unsigned integer.

```
hid_t new_type = H5Tcopy (H5T_NATIVE_INT);
H5Tset_precision(new_type, 1024);
H5Tset_sign(new_type, H5T_SGN_NONE);
```

Example 5. Create a new datatype

Composite datatypes are created with a specific API call for each datatype class. The table below shows the creation method for each datatype class. A newly created datatype cannot be used until the datatype properties are set. For example, a newly created compound datatype has no members and cannot be used.

Table 14. Functions to create each datatype class

Datatype Class	Function to Create
COMPOUND	H5Tcreate
OPAQUE	H5Tcreate
ENUM	H5Tenum_create
ARRAY	H5Tarray_create
VL	H5Tvlen_create

Once the datatype is created and the datatype properties set, the datatype object can be used.

Predefined datatypes are defined by the library during initialization using the same mechanisms as described here. Each predefined datatype is locked (`H5Tlock`), so that it cannot be changed or destroyed. User-defined datatypes may also be locked using `H5Tlock`.

6.4.3.1. User-defined Atomic Datatypes

Table 15 summarizes the API methods that set properties of atomic types. Table 16 shows properties specific to numeric types, Table 17 shows properties specific to the string datatype class. Note that offset, pad, etc. do not apply to strings. Table 18 shows the specific property of the OPAQUE datatype class.

Table 15. API methods that set properties of atomic datatypes

Functions	Description
<code>herr_t H5Tset_size (hid_t type, size_t size)</code>	Set the total size of the element in bytes. This includes padding which may appear on either side of the actual value. If this property is reset to a smaller value which would cause the significant part of the data to extend beyond the edge of the datatype, then the offset property is decremented a bit at a time. If the offset reaches zero and the significant part of the data still extends beyond the edge of the datatype then the precision property is decremented a bit at a time. Decreasing the size of a datatype may fail if the H5T_FLOAT bit fields would extend beyond the significant part of the type.
<code>herr_t H5Tset_order (hid_t type, H5T_order_t order)</code>	Set the byte order to little-endian (H5T_ORDER_LE) or big-endian (H5T_ORDER_BE).
<code>herr_t H5Tset_precision (hid_t type, size_t precision)</code>	Set the number of significant bits of a datatype. The offset property (defined below) identifies its location. The size property defined above represents the entire size (in bytes) of the datatype. If the precision is decreased then padding bits are inserted on the MSB side of the significant bits (this will fail for H5T_FLOAT types if it results in the sign, mantissa, or exponent bit field extending beyond the edge of the significant bit field). On the other hand, if the precision is increased so that it “hangs over” the edge of the total size then the offset property is decremented a bit at a time. If the offset reaches zero and the significant bits still hang over the edge, then the total size is increased a byte at a time.

`herr_t H5Tset_offset (hid_t type,
size_t offset)`

Set the bit location of the least significant bit of a bit field whose length is `precision`. The bits of the entire data are numbered beginning at zero at the least significant bit of the least significant byte (the byte at the lowest memory address for a little-endian type or the byte at the highest address for a big-endian type). The `offset` property defines the bit location of the least significant bit of a bit field whose length is `precision`. If the `offset` is increased so the significant bits “hang over” the edge of the datum, then the `size` property is automatically incremented.

`herr_t H5Tset_pad (hid_t type,
H5T_pad_t lsb, H5T_pad_t msb)`

Set the padding to zeros (`H5T_PAD_ZERO`) or ones (`H5T_PAD_ONE`). Padding is the bits of a data element which are not significant as defined by the `precision` and `offset` properties. Padding in the low-numbered bits is `lsb` padding and padding in the high-numbered bits is `msb` padding.

Table 16. API methods that set properties of numeric datatypes

Functions	Description
<code>herr_t H5Tset_sign (hid_t type, H5T_sign_t sign)</code>	(INTEGER) Integer data can be signed two's complement (<code>H5T_SGN_2</code>) or unsigned (<code>H5T_SGN_NONE</code>).
<code>herr_t H5Tset_fields (hid_t type, size_t spos, size_t epos, size_t esize, size_t mpos, size_t msize)</code>	(FLOAT) Set the properties define the location (bit position of least significant bit of the field) and size (in bits) of each field. The sign bit is always of length one and none of the fields are allowed to overlap.
<code>herr_t H5Tset_ebias (hid_t type, size_t ebias)</code>	(FLOAT) The exponent is stored as a non-negative value which is <code>ebias</code> larger than the true exponent.
<code>herr_t H5Tset_norm (hid_t type, H5T_norm_t norm)</code>	(FLOAT) This property describes the normalization method of the mantissa. <ul style="list-style-type: none"> • <code>H5T_NORM_MSBSET</code>: the mantissa is shifted left (if non-zero) until the first bit after the radix point is set and the exponent is adjusted accordingly. All bits of the mantissa after the radix point are stored. • <code>H5T_NORM_IMPLIED</code>: the mantissa is shifted left (if non-zero) until the first bit after the radix point is set and the exponent is adjusted accordingly. The first bit after the radix point is not stored since it is always set. • <code>H5T_NORM_NONE</code>: the fractional part of the mantissa is stored without normalizing it.
<code>herr_t H5Tset_inpad (hid_t type, H5T_pad_t inpad)</code>	(FLOAT) If any internal bits (that is, bits between the sign bit, the mantissa field, and the exponent field but within the precision field) are unused, then they will be filled according to the value of this property. The padding can be: <code>H5T_PAD_NONE</code> , <code>H5T_PAD_ZERO</code> or <code>H5T_PAD_ONE</code> .

Table 17. API methods that set properties of string datatypes

Functions	Description
<code>herr_t H5Tset_size (hid_t type, size_t size)</code>	Set the length of the string, in bytes. The precision is automatically set to 8*size.
<code>herr_t H5Tset_precision (hid_t type, size_t precision)</code>	The precision must be a multiple of 8.
<code>herr_t H5Tset_cset (hid_t type_id, H5T_cset_t cset)</code>	Two character sets are currently supported: ASCII (H5T_CSET_ASCII) and UTF-8 (H5T_CSET_UTF8).
<code>herr_t H5Tset_strpad (hid_t type_id, H5T_str_t strpad)</code>	<p>The string datatype has a fixed length, but the string may be shorter than the length. This property defines the storage mechanism for the left over bytes. The method used to store character strings differs with the programming language:</p> <ul style="list-style-type: none"> • C usually null terminates strings • Fortran left-justifies and space-pads strings <p>Valid string padding values, as passed in the parameter <code>strpad</code>, are as follows:</p> <p>H5T_STR_NULLTERM (0) Null terminate (as C does)</p> <p>H5T_STR_NULLPAD (1) Pad with zeros</p> <p>H5T_STR_SPACEPAD (2) Pad with spaces (as FORTRAN does).</p>

Table 18. API methods that set properties of opaque datatypes

Functions	Description
<code>herr_t H5Tset_tag (hid_t type_id const char *tag)</code>	Tags the opaque datatype <code>type_id</code> with an ASCII identifier <code>tag</code> .

Examples

The example below shows how to create a 128-bit little-endian signed integer type. Increasing the precision of a type automatically increases the total size. Note that the proper procedure is to begin from a type of the intended datatype class which in this case is a `NATIVE_INT`.

```
hid_t new_type = H5Tcopy (H5T_NATIVE_INT);
H5Tset_precision (new_type, 128);
H5Tset_order (new_type, H5T_ORDER_LE);
```

Example 6. Create a new 128-bit little-endian signed integer datatype

The figure below shows the storage layout as the type is defined. The `H5Tcopy` creates a datatype that is the same as `H5T_NATIVE_INT`. In this example, suppose this is a 32-bit big-endian number (Figure a). The precision is set to 128 bits, which automatically extends the size to 8 bytes (Figure b). Finally, the byte order is set to little-endian (Figure c).

Byte 0	Byte 1	Byte 2	Byte 3
01234567	89012345	67890123	45678901

a) The `H5T_NATIVE_INT` datatype

Byte 0	Byte 1	Byte 2	Byte 3	Byte 4	Byte 5	Byte 6	Byte 7
01234567	89012345	67890123	45678901	23456789	01234567	89012345	67890123

b) Precision is extended to 128-bits, and the size is automatically adjusted.

Byte 0	Byte 1	Byte 2	Byte 3	Byte 4	Byte 5	Byte 6	Byte 7
01234567	89012345	67890123	45678901	23456789	01234567	89012345	67890123

c) The byte order is switched.

Figure 6. The storage layout for a new 128-bit little-endian signed integer datatype

The significant bits of a data element can be offset from the beginning of the memory for that element by an amount of padding. The `offset` property specifies the number of bits of padding that appear to the “right of” the value. The table and figure below show how a 32-bit unsigned integer with 16-bits of precision having the value `0x1122` will be laid out in memory.

Table 19. Memory Layout for a 32-bit unsigned integer

Byte Position	Big-Endian Offset=0	Big-Endian Offset=16	Little-Endian Offset=0	Little-Endian Offset=16
0:	[pad]	[0x11]	[0x22]	[pad]
1:	[pad]	[0x22]	[0x11]	[pad]
2:	[0x11]	[pad]	[pad]	[0x22]
3:	[0x22]	[pad]	[pad]	[0x11]

Big-Endian: Offset = 0			
Byte 0	Byte 1	Byte 2	Byte 3
01234567	89012345	67890123	45678901
<i>PPPPPPPP</i>	<i>PPPPPPPP</i>	00010001	00100010

Big-Endian: Offset = 16			
Byte 0	Byte 1	Byte 2	Byte 3
01234567	89012345	67890123	45678901
00010001	00100010	<i>PPPPPPPP</i>	<i>PPPPPPPP</i>

Little-Endian: Offset = 0			
Byte 0	Byte 1	Byte 2	Byte 3
01234567	89012345	67890123	45678901
00010001	00100010	<i>PPPPPPPP</i>	<i>PPPPPPPP</i>

Little-Endian: Offset = 16			
Byte 0	Byte 1	Byte 2	Byte 3
01234567	89012345	67890123	45678901
<i>PPPPPPPP</i>	<i>PPPPPPPP</i>	00010001	00100010

Figure 7. Memory Layout for a 32-bit unsigned integer

If the offset is incremented then the total size is incremented also if necessary to prevent significant bits of the value from hanging over the edge of the datatype.

The bits of the entire data are numbered beginning at zero at the least significant bit of the least significant byte (the byte at the lowest memory address for a little-endian type or the byte at the highest address for a big-endian type). The `offset` property defines the bit location of the least significant bit of a bit field whose length is `precision`. If the offset is increased so the significant bits “hang over” the edge of the datum, then the `size` property is automatically incremented.

To illustrate the properties of the integer datatype class, the figure below shows how to create a user-defined datatype that describes a 24-bit signed integer that starts on the third bit of a 32-bit word. The datatype is specialized from a 32-bit integer, the *precision* is set to 24 bits, and the *offset* is set to 3.

```
hid_t dt;

dt = H5Tcopy(H5T_SDT_I32LE);

H5Tset_precision(dt, 24);
H5Tset_offset(dt, 3);
H5Tset_pad(dt, H5T_PAD_ZERO, H5T_PAD_ONE);
```

Figure 8. A user-defined datatype with a 24-bit signed integer

The figure below shows the storage layout for a data element. Note that the unused bits in the offset will be set to zero and the unused bits at the end will be set to one, as specified in the `H5Tset_pad` call.

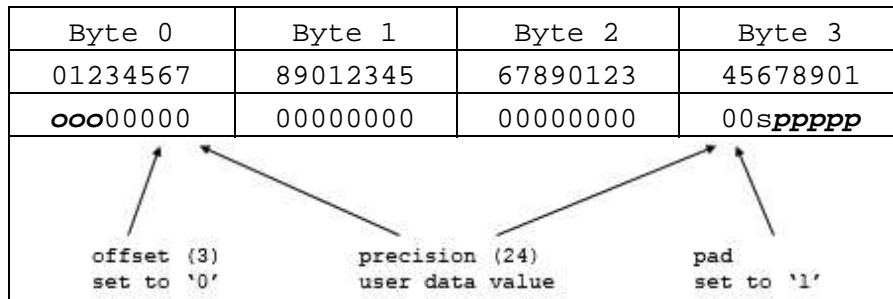

Figure 9. A user-defined integer datatype a range of -1,048,583 to 1,048,584

To illustrate a user-defined floating point number, the example below shows how to create a 24-bit floating point number that starts 5 bits into a 4 byte word. The floating point number is defined to have a mantissa of 19 bits (bits 5-23), an exponent of 3 bits (25-27), and the sign bit is bit 28. (Note that this is an illustration of what can be done and is not necessarily a floating point format that a user would require.)

```
hid_t dt;

dt = H5Tcopy(H5T_IEEE_F32LE);

H5Tset_precision(dt, 24);
H5Tset_fields(dt, 28, 25, 3, 5, 19);
H5Tset_pad(dt, H5T_PAD_ZERO, H5T_PAD_ONE);
H5Tset_inpad(dt, H5T_PAD_ZERO);
```

Example 7. A user-defined 24-bit floating point datatype

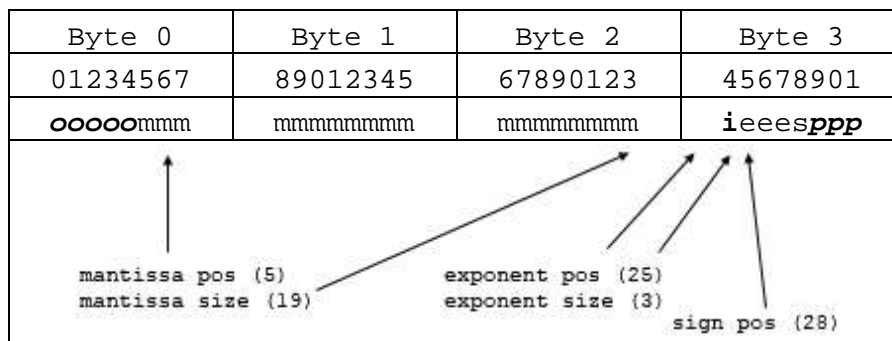

Figure 10. A user-defined floating point datatype

The figure above shows the storage layout of a data element for this datatype. Note that there is an unused bit (24) between the mantissa and the exponent. This bit is filled with the *inpad* value which in this case is 0.

The sign bit is always of length one and none of the fields are allowed to overlap. When expanding a floating-point type one should set the precision first; when decreasing the size one should set the field positions and sizes first.

6.4.3.2. Composite Datatypes

All composite datatypes must be user-defined; there are no predefined composite datatypes.

6.4.3.2.1. Compound Datatypes

The subsections below describe how to create a compound datatype and how to write and read data of a compound datatype.

6.4.3.2.1.1. Defining Compound Datatypes

Compound datatypes are conceptually similar to a C struct or Fortran derived types. The compound datatype defines a contiguous sequence of bytes, which are formatted using one up to 2^{16} datatypes (members). A compound datatype may have any number of members, in any order, and the members may have any datatype, including compound. Thus, complex nested compound datatypes can be created. The total size of the compound datatype is greater than or equal to the sum of the size of its members, up to a maximum of 2^{32} bytes. HDF5 does not support datatypes with distinguished records or the equivalent of C unions or Fortran EQUIVALENCE statements.

Usually a C struct or Fortran derived type will be defined to hold a data point in memory, and the offsets of the members in memory will be the offsets of the struct members from the beginning of an instance of the struct. The HDF5 C library provides a macro `HOFFSET(s, m)` to calculate the member's offset. The HDF5 Fortran applications have to calculate offsets by using sizes of members datatypes and by taking in consideration the order of members in the Fortran derived type.

`HOFFSET(s, m)`

This macro computes the offset of member *m* within a struct *s*

`offsetof(s, m)`

This macro defined in `stddef.h` does exactly the same thing as the `HOFFSET()` macro.

Note for Fortran users: Offsets of Fortran structure members correspond to the offsets within a packed datatype (see explanation below) stored in an HDF5 file.

Each member of a compound datatype must have a descriptive name which is the key used to uniquely identify the member within the compound datatype. A member name in an HDF5 datatype does not necessarily have to be the same as the name of the member in the C struct or Fortran derived type, although this is often the case. Nor does one need to define all members of the C struct or Fortran derived type in the HDF5 compound datatype (or vice versa).

Unlike atomic datatypes which are derived from other atomic datatypes, compound datatypes are created from scratch. First, one creates an empty compound datatype and specifies its total size. Then members are added to the compound datatype in any order. Each member type is inserted at a designated offset. Each member has a name which is the key used to uniquely identify the member within the compound datatype.

The example below shows a way of creating an HDF5 C compound datatype to describe a complex number. This is a structure with two components, “real” and “imaginary”, and each component is a double. An equivalent C struct whose type is defined by the `complex_t` struct is shown.

```
typedef struct {
    double re; /*real part*/
    double im; /*imaginary part*/
} complex_t;

hid_t complex_id = H5Tcreate (H5T_COMPOUND, sizeof (complex_t));
H5Tinsert (complex_id, "real", HOFFSET(complex_t,re),
          H5T_NATIVE_DOUBLE);
H5Tinsert (complex_id, "imaginary", HOFFSET(complex_t,im),
          H5T_NATIVE_DOUBLE);
```

Example 8. A compound datatype for complex numbers in C

The example below shows a way of creating an HDF5 Fortran compound datatype to describe a complex number. This is a Fortran derived type with two components, “real” and “imaginary”, and each component is `DOUBLE PRECISION`. An equivalent Fortran `TYPE` whose type is defined by the `TYPE complex_t` is shown.

```

TYPE complex_t
  DOUBLE PRECISION re    ! real part
  DOUBLE PRECISION im;  ! imaginary part
END TYPE complex_t

CALL h5tget_size_f(H5T_NATIVE_DOUBLE, re_size, error)
CALL h5tget_size_f(H5T_NATIVE_DOUBLE, im_size, error)
complex_t_size = re_size + im_size
CALL h5tcreate_f(H5T_COMPOUND_F, complex_t_size, type_id)
offset = 0
CALL h5tinsert_f(type_id, "real", offset, H5T_NATIVE_DOUBLE, error)
offset = offset + re_size
CALL h5tinsert_f(type_id, "imaginary", offset, H5T_NATIVE_DOUBLE, error)

```

Example 9. A compound datatype for complex numbers in Fortran

Important Note: The compound datatype is created with a size sufficient to hold all its members. In the C example above, the size of the C struct and the `HOFFSET` macro are used as a convenient mechanism to determine the appropriate size and offset. Alternatively, the size and offset could be manually determined: the size can be set to 16 with “real” at offset 0 and “imaginary” at offset 8. However, different platforms and compilers have different sizes for “double” and may have alignment restrictions which require additional padding within the structure. It is much more portable to use the `HOFFSET` macro which assures that the values will be correct for any platform.

The figure below shows how the compound datatype would be laid out assuming that `NATIVE_DOUBLE` are 64-bit numbers and that there are no alignment requirements. The total size of the compound datatype will be 16 bytes, the “real” component will start at byte 0, and “imaginary” will start at byte 8.

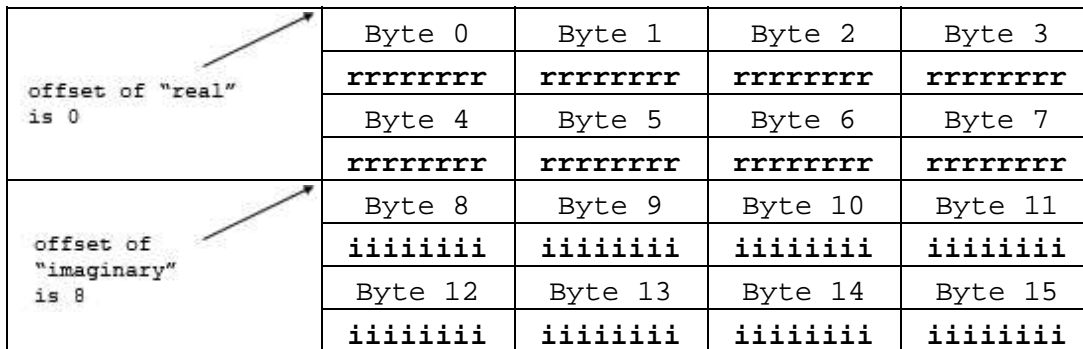

Total size of Compound Datatype is 16 bytes

Figure 11. Layout of a compound datatype

The members of a compound datatype may be any HDF5 datatype including the compound, array, and variable-length (VL) types. The figure and example below show the memory layout and code which creates a compound datatype composed of two complex values, and each complex value is also a compound datatype as in the figure above.

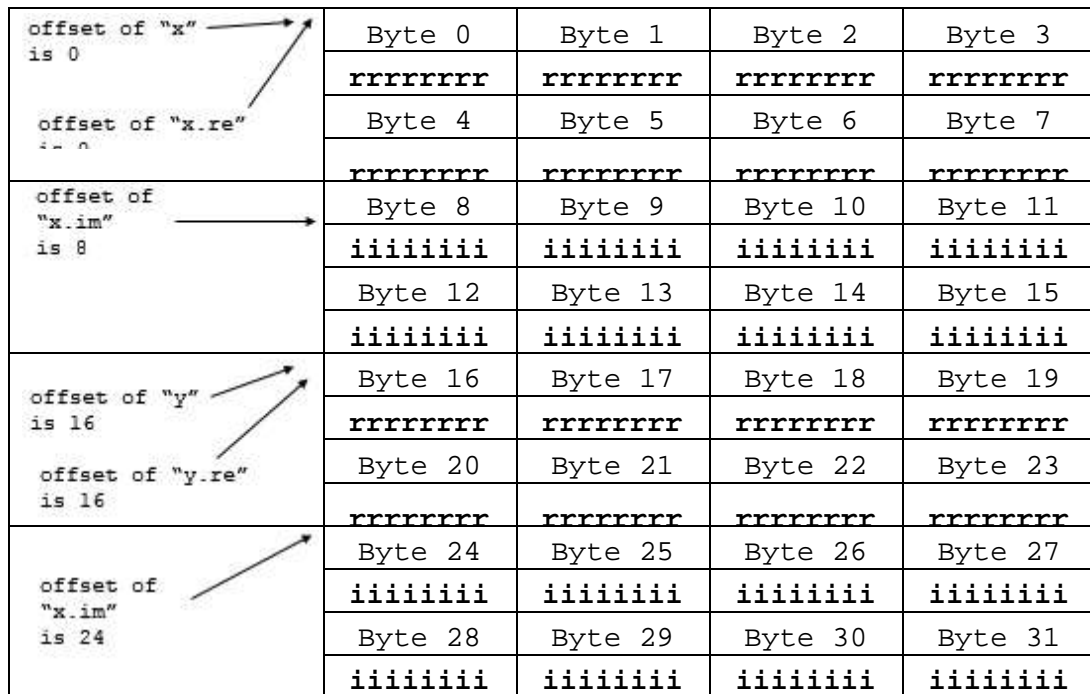

Total size of Compound Datatype is 32 bytes.

Figure 12. Layout of a compound datatype nested within a compound datatype

```

typedef struct {
    complex_t x;
    complex_t y;
} surf_t;

hid_t complex_id, surf_id; /*hdf5 datatypes*/

complex_id = H5Tcreate (H5T_COMPOUND, sizeof(complex_t));
H5Tinsert (complex_id, "re", HOFFSET(complex_t,re),
           H5T_NATIVE_DOUBLE);
H5Tinsert (complex_id, "im", HOFFSET(complex_t,im),
           H5T_NATIVE_DOUBLE);

surf_id = H5Tcreate (H5T_COMPOUND, sizeof(surf_t));
H5Tinsert (surf_id, "x", HOFFSET(surf_t,x), complex_id);
H5Tinsert (surf_id, "y", HOFFSET(surf_t,y), complex_id);

```

Example 10. Code for a compound datatype nested within a compound datatype

Note that a similar result could be accomplished by creating a compound datatype and inserting four fields. See the figure below. This results in the same layout as the figure above. The difference would be how the fields are addressed. In the first case, the real part of 'y' is called 'y.re'; in the second case it is 'y-re'.

```

typedef struct {
    complex_t x;
    complex_t y;
} surf_t;

hid_t surf_id = H5Tcreate (H5T_COMPOUND, sizeof(surf_t));
H5Tinsert (surf_id, "x-re", HOFFSET(surf_t,x.re),
          H5T_NATIVE_DOUBLE);
H5Tinsert (surf_id, "x-im", HOFFSET(surf_t,x.im),
          H5T_NATIVE_DOUBLE);
H5Tinsert (surf_id, "y-re", HOFFSET(surf_t,y.re),
          H5T_NATIVE_DOUBLE);
H5Tinsert (surf_id, "y-im", HOFFSET(surf_t,y.im),
          H5T_NATIVE_DOUBLE);

```

Example 11. Another compound datatype nested within a compound datatype

The members of a compound datatype do not always fill all the bytes. The `HOFFSET` macro assures that the members will be laid out according to the requirements of the platform and language. The example below shows an example of a C struct which requires extra bytes of padding on many platforms. The second element, 'b', is a 1-byte character followed by an 8 byte double, 'c'. On many systems, the 8-byte value must be stored on a 4- or 8-byte boundary. This requires the struct to be larger than the sum of the size of its elements.

In the example below, `sizeof` and `HOFFSET` are used to assure that the members are inserted at the correct offset to match the memory conventions of the platform. The figure below shows how this data element would be stored in memory, assuming the double must start on a 4-byte boundary. Notice the extra bytes between 'b' and 'c'.

```

typedef struct s1_t {
    int    a;
    char  b;
    double c;
} s1_t;

s1_tid = H5Tcreate (H5T_COMPOUND, sizeof(s1_t));
H5Tinsert(s1_tid, "a_name", HOFFSET(s1_t, a), H5T_NATIVE_INT);
H5Tinsert(s1_tid, "b_name", HOFFSET(s1_t, b), H5T_NATIVE_CHAR);
H5Tinsert(s1_tid, "c_name", HOFFSET(s1_t, c), H5T_NATIVE_DOUBLE);

```

Example 12. A compound datatype that requires padding

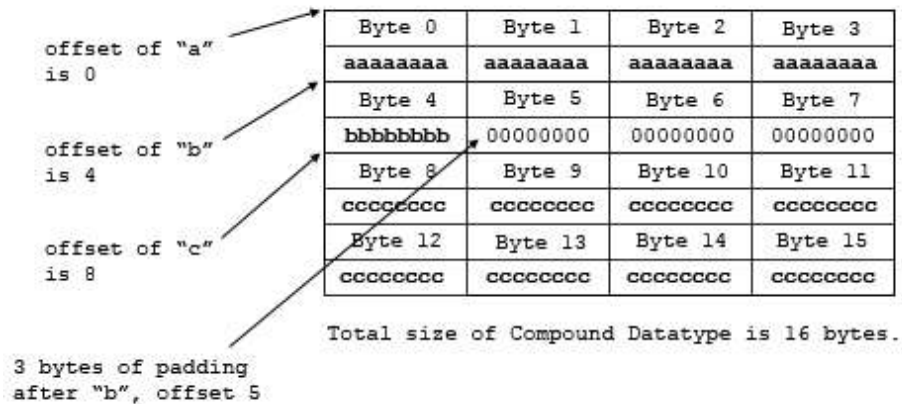

Figure 13. Memory layout of a compound datatype that requires padding

However, data stored on disk does not require alignment, so unaligned versions of compound data structures can be created to improve space efficiency on disk. These unaligned compound datatypes can be created by computing offsets by hand to eliminate inter-member padding, or the members can be packed by calling `H5Tpack` (which modifies a datatype directly, so it is usually preceded by a call to `H5Tcopy`).

The example below shows how to create a disk version of the compound datatype from the figure above in order to store data on disk in as compact a form as possible. Packed compound datatypes should generally not be used to describe memory as they may violate alignment constraints for the architecture being used. Note also that using a packed datatype for disk storage may involve a higher data conversion cost.

```
hid_t s2_tid = H5Tcopy (s1_tid);
             H5Tpack (s2_tid);
```

Example 13. Create a packed compound datatype in C

The example below shows the sequence of Fortran calls to create a packed compound datatype. An HDF5 Fortran compound datatype never describes a compound datatype in memory and compound data is *ALWAYS* written by fields as described in the next section. Therefore packing is not needed unless the offset of each consecutive member is not equal to the sum of the sizes of the previous members.

```
CALL h5tcopy_f(s1_id, s2_id, error)
CALL h5tpack_f(s2_id, error)
```

Example 14. Create a packed compound datatype in Fortran

6.4.3.2.1.2. Creating and Writing Datasets with Compound Datatypes

Creating datasets with compound datatypes is similar to creating datasets with any other HDF5 datatypes. But writing and reading may be different since datasets that have compound datatypes can be written or read by a field (member) or subsets of fields (members). The compound datatype is the only composite datatype that supports “sub-setting” by the elements the datatype is built from.

The example below shows a C example of creating and writing a dataset with a compound datatype.

```
typedef struct s1_t {
    int    a;
    float  b;
    double c;
} s1_t;

s1_t data[LENGTH];

/* Initialize data */
for (i = 0; i < LENGTH; i++) {
    data[i].a = i;
    data[i].b = i*i;
    data[i].c = 1./(i+1);
    ...
s1_tid = H5Tcreate (H5T_COMPOUND, sizeof(s1_t));
H5Tinsert(s1_tid, "a_name", HOFFSET(s1_t, a), H5T_NATIVE_INT);
H5Tinsert(s1_tid, "b_name", HOFFSET(s1_t, b), H5T_NATIVE_FLOAT);
H5Tinsert(s1_tid, "c_name", HOFFSET(s1_t, c), H5T_NATIVE_DOUBLE);
...
dataset_id = H5Dcreate(file_id, "SDScompound.h5", s1_t, space_id,
                      H5P_DEFAULT, H5P_DEFAULT, H5P_DEFAULT);
H5Dwrite (dataset_id, s1_tid, H5S_ALL, H5S_ALL, H5P_DEFAULT, data);
```

Example 15. Create and write a dataset with a compound datatype in C

The example below shows the content of the file written on a little-endian machine.

```
HDF5 "SDScompound.h5" {
GROUP "/" {
  DATASET "ArrayOfStructures" {
    DATATYPE H5T_COMPOUND {
      H5T_STD_I32LE "a_name";
      H5T_IEEE_F32LE "b_name";
      H5T_IEEE_F64LE "c_name";
    }
    DATASPACE SIMPLE { ( 3 ) / ( 3 ) }
    DATA {
      (0): {
        0,
        0,
        1
      },
      (1): {
        1,
        1,
        0.5
      },
      (2): {
        2,
        4,
        0.333333
      }
    }
  }
}
}
```

Example 16. Create and write a little-endian dataset with a compound datatype in C

It is not necessary to write the whole data at once. Datasets with compound datatypes can be written by field or by subsets of fields. In order to do this one has to remember to set the transfer property of the dataset using the `H5Pset_preserve` call and to define the memory datatype that corresponds to a field. The example below shows how float and double fields are written to the dataset.

```
typedef struct sb_t {
    float b;
    double c;
} sb_t;

typedef struct sc_t {
    float b;
    double c;
} sc_t;
sb_t data1[LENGTH];
sc_t data2[LENGTH];

/* Initialize data */
for (i = 0; i < LENGTH; i++) {
    data1.b = i*i;
    data2.c = 1./(i+1);
}
...
/* Create dataset as in example 15 */
```

```

...
/* Create memory datatypes corresponding to float and double
datatype fields */

sb_tid = H5Tcreate (H5T_COMPOUND, sizeof(sb_t));
H5Tinsert(sb_tid, "b_name", HOFFSET(sb_t, b), H5T_NATIVE_FLOAT);
sc_tid = H5Tcreate (H5T_COMPOUND, sizeof(sc_t));
H5Tinsert(sc_tid, "c_name", HOFFSET(sc_t, c), H5T_NATIVE_DOUBLE);
...
/* Set transfer property */
xfer_id = H5Pcreate(H5P_DATASET_XFER);
H5Pset_preserve(xfer_id, 1);
H5Dwrite (dataset_id, sb_tid, H5S_ALL, H5S_ALL, xfer_id, data1);
H5Dwrite (dataset_id, sc_tid, H5S_ALL, H5S_ALL, xfer_id, data2);

```

Example 17. Writing floats and doubles to a dataset

The figure below shows the content of the file written on a little-endian machine. Only float and double fields are written. The default fill value is used to initialize the unwritten integer field.

```

HDF5 "SDScompound.h5" {
GROUP "/" {
  DATASET "ArrayOfStructures" {
    DATATYPE H5T_COMPOUND {
      H5T_STD_I32LE "a_name";
      H5T_IEEE_F32LE "b_name";
      H5T_IEEE_F64LE "c_name";
    }
    DATASPACE SIMPLE { ( 3 ) / ( 3 ) }
    DATA {
      (0): {
        0,
        0,
        1
      },
      (1): {
        0,
        1,
        0.5
      },
      (2): {
        0,
        4,
        0.333333
      }
    }
  }
}
}

```

Example 18. Writing floats and doubles to a dataset on a little-endian system

The example below contains a Fortran example that creates and writes a dataset with a compound datatype. As this example illustrates, writing and reading compound datatypes in Fortran is *always* done by fields. The content of the written file is the same as shown in the example above.

```

! One cannot write an array of a derived datatype in Fortran.
TYPE s1_t
  INTEGER          a
  REAL             b
  DOUBLE PRECISION c
END TYPE s1_t
TYPE(s1_t) d(LENGTH)

! Therefore, the following code initializes an array corresponding
! to each field in the derived datatype and writes those arrays
! to the dataset

INTEGER, DIMENSION(LENGTH)      :: a
REAL, DIMENSION(LENGTH)         :: b
DOUBLE PRECISION, DIMENSION(LENGTH) :: c

! Initialize data
do i = 1, LENGTH
  a(i) = i-1
  b(i) = (i-1) * (i-1)
  c(i) = 1./i
enddo

...

! Set dataset transfer property to preserve partially initialized fields
! during write/read to/from dataset with compound datatype.
!
CALL h5pcreate_f(H5P_DATASET_XFER_F, plist_id, error)
CALL h5pset_preserve_f(plist_id, .TRUE., error)
...
!
! Create compound datatype.
!
! First calculate total size by calculating sizes of each member
!
CALL h5tget_size_f(H5T_NATIVE_INTEGER, type_sizei, error)
CALL h5tget_size_f(H5T_NATIVE_REAL, type_sizer, error)
CALL h5tget_size_f(H5T_NATIVE_DOUBLE, type_sized, error)
type_size = type_sizei + type_sizer + type_sized
CALL h5tcreate_f(H5T_COMPOUND_F, type_size, dtype_id, error)
!
! Insert members
!
! INTEGER member
!
offset = 0
CALL h5tinsert_f(dtype_id, "a_name", offset, H5T_NATIVE_INTEGER, error)
!
! REAL member
!
offset = offset + type_sizei
CALL h5tinsert_f(dtype_id, "b_name", offset, H5T_NATIVE_REAL, error)
!

```

```

! DOUBLE PRECISION member
!
offset = offset + type_sizer
CALL h5tinsert_f(dtype_id, "c_name", offset, H5T_NATIVE_DOUBLE, error)

!
! Create the dataset with compound datatype.
!
CALL h5dcreate_f(file_id, dsetname, dtype_id, dspace_id, &
                 dset_id, error, H5P_DEFAULT_F, H5P_DEFAULT_F, H5P_DEFAULT_F)
!
...
! Create memory types. We have to create a compound datatype
! for each member we want to write.
!
!
CALL h5tcreate_f(H5T_COMPOUND_F, type_sizei, dt1_id, error)
offset = 0
CALL h5tinsert_f(dt1_id, "a_name", offset, H5T_NATIVE_INTEGER, error)
!
CALL h5tcreate_f(H5T_COMPOUND_F, type_sizer, dt2_id, error)
offset = 0
CALL h5tinsert_f(dt2_id, "b_name", offset, H5T_NATIVE_REAL, error)
!
CALL h5tcreate_f(H5T_COMPOUND_F, type_sized, dt3_id, error)
offset = 0
CALL h5tinsert_f(dt3_id, "c_name", offset, H5T_NATIVE_DOUBLE, error)
!
! Write data by fields in the datatype. Fields order is not important.
!
CALL h5dwrite_f(dset_id, dt3_id, c, data_dims, error, xfer_prp = plist_id)
CALL h5dwrite_f(dset_id, dt2_id, b, data_dims, error, xfer_prp = plist_id)
CALL h5dwrite_f(dset_id, dt1_id, a, data_dims, error, xfer_prp = plist_id)

```

Example 19. Create and write a dataset with a compound datatype in Fortran

6.4.3.2.1.3. Reading Datasets with Compound Datatypes

Reading datasets with compound datatypes may be a challenge. For general applications there is no way to know *a priori* the corresponding C structure. Also, C structures cannot be allocated on the fly during discovery of the dataset's datatype. For general C, C++, Fortran and Java application the following steps will be required to read and to interpret data from the dataset with compound datatype:

1. Get the identifier of the compound datatype in the file with the `H5Dget_type` call
2. Find the number of the compound datatype members with the `H5Tget_nmembers` call
3. Iterate through compound datatype members
 - ◇ Get member class with the `H5Tget_member_class` call
 - ◇ Get member name with the `H5Tget_member_name` call
 - ◇ Check class type against predefined classes
 - `H5T_INTEGER`
 - `H5T_FLOAT`
 - `H5T_STRING`
 - `H5T_BITFIELD`
 - `H5T_OPAQUE`
 - `H5T_COMPOUND`
 - `H5T_REFERENCE`
 - `H5T_ENUM`
 - `H5T_VLEN`
 - `H5T_ARRAY`
 - ◇ If class is `H5T_COMPOUND`, then go to step 2 and repeat all steps under step 3. If class is not `H5T_COMPOUND`, then a member is of an atomic class and can be read to a corresponding buffer after discovering all necessary information specific to each atomic type (e.g. size of the integer or floats, super class for enumerated and array datatype, and it sizes, etc.)

The examples below show how to read a dataset with a known compound datatype.

The first example below shows the steps needed to read data of a known structure. First, build a memory datatype the same way it was built when the dataset was created, and then second use the datatype in a H5Dread call.

```
typedef struct s1_t {
    int    a;
    float  b;
    double c;
} s1_t;

s1_t *data;

...
s1_tid = H5Tcreate(H5T_COMPOUND, sizeof(s1_t));
H5Tinsert(s1_tid, "a_name", HOFFSET(s1_t, a), H5T_NATIVE_INT);
H5Tinsert(s1_tid, "b_name", HOFFSET(s1_t, b), H5T_NATIVE_FLOAT);
H5Tinsert(s1_tid, "c_name", HOFFSET(s1_t, c), H5T_NATIVE_DOUBLE);
...
dataset_id = H5Dopen(file_id, "SDScompound.h5", H5P_DEFAULT);
...
data = (s1_t *) malloc (sizeof(s1_t)*LENGTH);
H5Dread(dataset_id, s1_tid, H5S_ALL, H5S_ALL, H5P_DEFAULT, data);
```

Example 20. Read a dataset using a memory datatype

Instead of building a memory datatype, the application could use the H5Tget_native_type function. See the example below.

```
typedef struct s1_t {
    int    a;
    float  b;
    double c;
} s1_t;

s1_t *data;
hid_t file_s1_t, mem_s1_t;

...
dataset_id = H5Dopen(file_id, "SDScompound.h5", H5P_DEFAULT);
/* Discover datatype in the file */
file_s1_t = H5Dget_type(dataset_id);
/* Find corresponding memory datatype */
mem_s1_t = H5Tget_native_type(file_s1_t, H5T_DIR_DEFAULT);

...
data = (s1_t *) malloc (sizeof(s1_t)*LENGTH);
H5Dread (dataset_id, mem_s1_tid, H5S_ALL, H5S_ALL, H5P_DEFAULT, data);
```

Example 21. Read a dataset using H5Tget_native_type

The example below shows how to read just one float member of a compound datatype.

```
typedef struct s1_t {
    float b;
} sf_t;

sf_t *data;

...
sf_tid = H5Tcreate(H5T_COMPOUND, sizeof(sf_t));
H5Tinsert(sf_tid, "b_name", HOFFSET(sf_t, b), H5T_NATIVE_FLOAT);
...
dataset_id = H5Dopen(file_id, "SDScompound.h5", H5P_DEFAULT);
...
data = (sf_t *) malloc (sizeof(sf_t)*LENGTH);
H5Dread(dataset_id, sf_tid, H5S_ALL, H5S_ALL, H5P_DEFAULT, data);
```

Example 22. Read one floating point member of a compound datatype

The example below shows how to read float and double members of a compound datatype into a structure that has those fields in a different order. Please notice that `H5Tinsert` calls can be used in an order different from the order of the structure's members.

```
typedef struct s1_t {
    double c;
    float b;
} sdf_t;

sdf_t *data;

...
sdf_tid = H5Tcreate(H5T_COMPOUND, sizeof(sdf_t));
H5Tinsert(sdf_tid, "b_name", HOFFSET(sdf_t, b), H5T_NATIVE_FLOAT);
H5Tinsert(sdf_tid, "c_name", HOFFSET(sdf_t, c), H5T_NATIVE_DOUBLE);
...
dataset_id = H5Dopen(file_id, "SDScompound.h5", H5P_DEFAULT);
...
data = (sdf_t *) malloc (sizeof(sdf_t)*LENGTH);
H5Dread(dataset_id, sdf_tid, H5S_ALL, H5S_ALL, H5P_DEFAULT, data);
```

Example 23. Read float and double members of a compound datatype

6.4.3.2.2. Array

Many scientific datasets have multiple measurements for each point in a space. There are several natural ways to represent this data, depending on the variables and how they are used in computation. See the table and the figure below.

Table 20. Representing data with multiple measurements

Storage Strategy	Stored as	Remarks
Multiple planes	Several datasets with identical dataspace	This is optimal when variables are accessed individually, or when often uses only selected variables.
Additional dimension	One dataset, the last “dimension” is a vector of variables	This can give good performance, although selecting only a few variables may be slow. This may not reflect the science.
Record with multiple values	One dataset with compound datatype	This enables the variables to be read all together or selected. Also handles “vectors” of heterogenous data.
Vector or Tensor value	One dataset, each data element is a small array of values.	This uses the same amount of space as the previous two, and may represent the science model better.

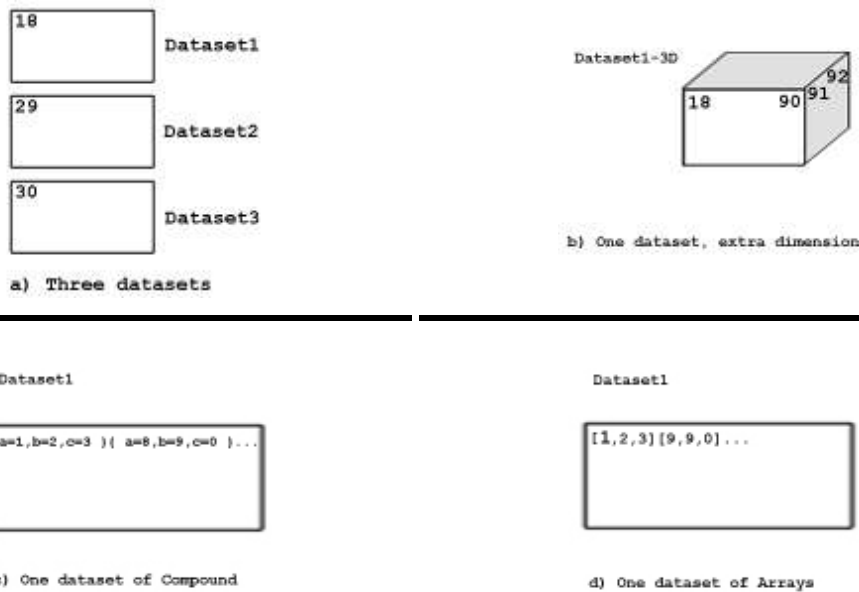

Figure 14. Representing data with multiple measurements

The HDF5 `H5T_ARRAY` datatype defines the data element to be a homogeneous, multi-dimensional array. See Figure 14d above. The elements of the array can be any HDF5 datatype (including compound and array), and the size of the datatype is the total size of the array. A dataset of array datatype cannot be subdivided for I/O within the data element: the entire array of the data element must be transferred. If the data elements need to be accessed separately, e.g., by plane, then the array datatype should not be used. The table below shows advantages and disadvantages of various storage methods.

Table 21. Storage method advantages and disadvantages

Method	Advantages	Disadvantages
a) Multiple Datasets	<ul style="list-style-type: none"> • Easy to access each plane, can select any plane(s) 	<ul style="list-style-type: none"> • Less efficient to access a 'column' through the planes
b) N+1 Dimension	<ul style="list-style-type: none"> • All access patterns supported 	<ul style="list-style-type: none"> • Must be homogeneous datatype • The added dimension may not make sense in the scientific model
c) Compound Datatype	<ul style="list-style-type: none"> • Can be heterogenous datatype 	<ul style="list-style-type: none"> • Planes must be named, selection is by plane • Not a natural representation for a matrix
d) Array	<ul style="list-style-type: none"> • A natural representation for vector or tensor data 	<ul style="list-style-type: none"> • Cannot access elements separately (no access by plane)

An array datatype may be multi-dimensional with 1 to H5S_MAX_RANK (the maximum rank of a dataset is currently 32) dimensions. The dimensions can be any size greater than 0, but unlimited dimensions are not supported (although the datatype can be a variable-length datatype).

An array datatype is created with the `H5Tarray_create` call, which specifies the number of dimensions, the size of each dimension, and the base type of the array. The array datatype can then be used in any way that any datatype object is used. The example below shows the creation of a datatype that is a two-dimensional array of native integers, and this is then used to create a dataset. Note that the dataset can be a dataspace that is any number and size of dimensions. The figure below shows the layout in memory assuming that the native integers are 4 bytes. Each data element has 6 elements, for a total of 24 bytes.

```

hid_t      file, dataset;
hid_t      datatype, dataspace;
hsize_t    adims[] = {3, 2};

datatype = H5Tarray_create(H5T_NATIVE_INT, 2, adims, NULL);

dataset = H5Dcreate(file, datasetname, datatype, dataspace,
                   H5P_DEFAULT, H5P_DEFAULT, H5P_DEFAULT);

```

Example 24. Create a two-dimensional array datatype

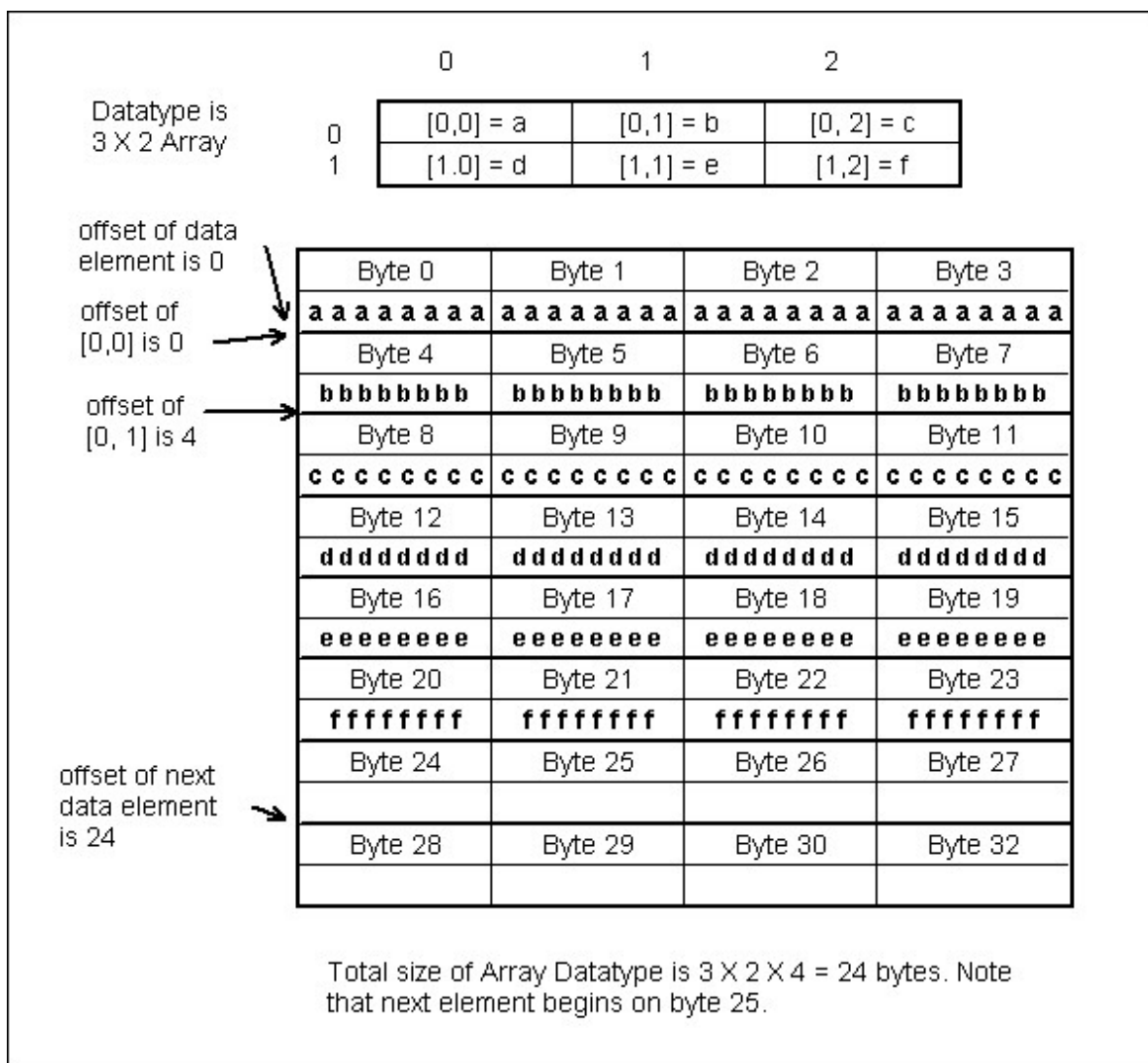

Figure 15. Memory layout of a two-dimensional array datatype

6.4.3.2.3. Variable-length Datatypes

A variable-length (VL) datatype is a one-dimensional sequence of a datatype which are not fixed in length from one dataset location to another, i.e., each data element may have a different number of members. Variable-length datatypes cannot be divided, the entire data element must be transferred.

VL datatypes are useful to the scientific community in many different ways, possibly including:

- *Ragged arrays*: Multi-dimensional ragged arrays can be implemented with the last (fastest changing) dimension being ragged by using a VL datatype as the type of the element stored.
- *Fractal arrays*: A nested VL datatype can be used to implement ragged arrays of ragged arrays, to whatever nesting depth is required for the user.
- *Polygon lists*: A common storage requirement is to efficiently store arrays of polygons with different numbers of vertices. A VL datatypes can be used to efficiently and succinctly describe an array of polygons with different numbers of vertices.
- *Character strings*: Perhaps the most common use of VL datatypes will be to store C-like VL character strings in dataset elements or as attributes of objects.
- *Indices, e.g. of objects within the file*: An array of VL object references could be used as an index to all the objects in a file which contain a particular sequence of dataset values.
- *Object Tracking*: An array of VL dataset region references can be used as a method of tracking objects or features appearing in a sequence of datasets.

A VL datatype is created by calling `H5Tvlen_create` which specifies the base datatype. The first example below shows an example of code that creates a VL datatype of unsigned integers. Each data element is a one-dimensional array of zero or more members and is stored in the `hvl_t` structure. See the second example below.

```
tid1 = H5Tvlen_create (H5T_NATIVE_UINT);

dataset=H5Dcreate(fid1, "Dataset1", tid1, sid1, H5P_DEFAULT,
                 H5P_DEFAULT, H5P_DEFAULT);
```

Example 25. Create a variable-length datatype of unsigned integers

```
typedef struct {
    size_t len; /* Length of VL data (in base type units) */
    void *p;   /* Pointer to VL data */
} hvl_t;
```

Example 26. Data element storage for members of the VL datatype

The first example below shows how the VL data is written. For each of the 10 data elements, a length and data buffer must be allocated. Below the two examples is a figure that shows how the data is laid out in memory.

An analogous procedure must be used to read the data. See the second example below. An appropriate array of `vl_t` must be allocated, and the data read. It is then traversed one data element at a time. The `H5Dvlen_reclaim` call frees the data buffer for the buffer. With each element possibly being of different sequence lengths for a dataset with a VL datatype, the memory for the VL datatype must be dynamically allocated. Currently there are two methods of managing the memory for VL datatypes: the standard C `malloc/free` memory allocation routines or a method of calling user-defined memory management routines to allocate or free memory (set with `H5Pset_vlen_mem_manager`). Since the memory allocated when reading (or writing) may be complicated to release, the `H5Dvlen_reclaim` function is provided to traverse a memory buffer and free the VL datatype information without leaking memory.

```

hvl_t wdata[10];          /* Information to write */

/* Allocate and initialize VL data to write */
for(i=0; i < 10; i++) {
    wdata[i].p = malloc((i+1)*sizeof(unsigned int));
    wdata[i].len = i+1;
    for(j=0; j

```

Example 27. Write VL data

```

hvl_t rdata[SPACE1_DIM1];
ret=H5Dread(dataset, tid1, H5S_ALL, H5S_ALL, xfer_pid, rdata);

for(i=0; i<SPACE1_DIM1; i++) {
    printf("%d: len %d ",rdata[i].len);
    for(j=0; j<rdata[i].len; j++) {
        printf(" value: %u\n",((unsigned int *)rdata[i].p)[j]);
    }
}
ret=H5Dvlen_reclaim(tid1, sid1, xfer_pid, rdata);

```

Example 28. Read VL data

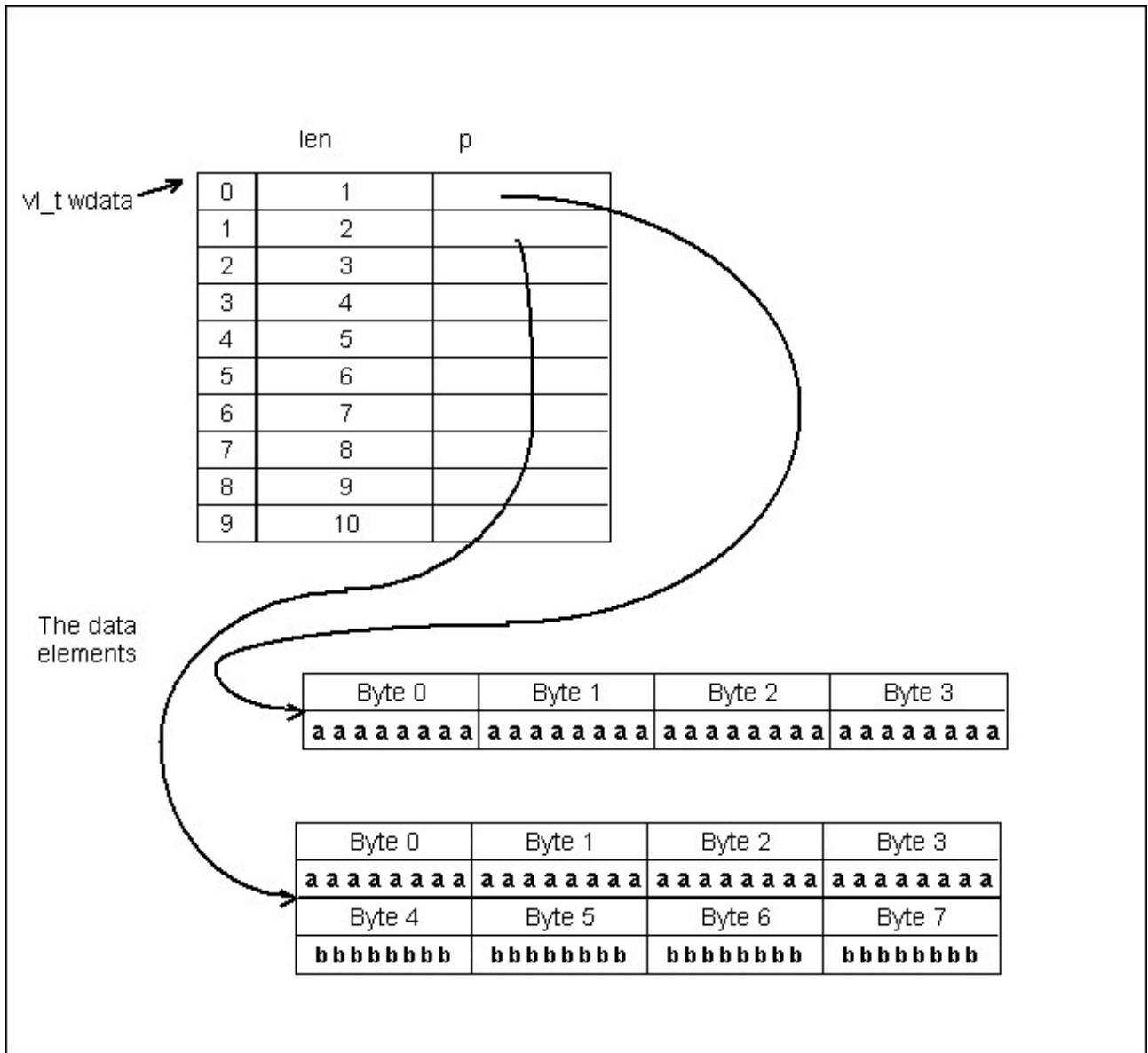

Figure 16. Memory layout of a VL datatype

The user program must carefully manage these relatively complex data structures. The `H5Dvlen_reclaim` function performs a standard traversal, freeing all the data. This function analyzes the datatype and dataspace objects, and visits each VL data element, recursing through nested types. By default, the system `free` is called for the pointer in each `vl_t`. Obviously, this call assumes that all of this memory was allocated with the system `malloc`.

The user program may specify custom memory manager routines, one for allocating and one for freeing. These may be set with the `H5Pvlen_mem_manager`, and must have the following prototypes:

- `typedef void *(*H5MM_allocate_t)(size_t size, void *info);`
- `typedef void (*H5MM_free_t)(void *mem, void *free_info);`

The utility function `H5Dget_vlen_buf_size` checks the number of bytes required to store the VL data from the dataset. This function analyzes the datatype and dataspace object to visit all the VL data elements, to determine the number of bytes required to store the data for the in the destination storage (memory). The `size` value is adjusted for data conversion and alignment in the destination.

6.5. Other Non-numeric Datatypes

Several datatype classes define special types of objects.

6.5.1. Strings

Text data is represented by arrays of characters, called strings. Many programming languages support different conventions for storing strings, which may be fixed or variable-length, and may have different rules for padding unused storage. HDF5 can represent strings in several ways. See the figure below.

The Strings to store are: "Four score",
"lazy programmers."

- a) H5T_NATIVE_CHAR the dataset is a one-dimensional array with 29 elements, each element is a single character.

0	1	2	3	4	...	25	26	27	28
'F'	'o'	'u'	'r'	' '	...	'r'	's'	'.'	'\0'

- b) Fixed-length string

The dataset is a one-dimensional array with 2 elements, each element is 20 characters.

0	"Four score\0"
1	"lazy programmers.\0"

- c) Variable-length string

The dataset is a one-dimensional array with 2 elements, each element is a variable-length string.

This is the same result when stored as fixed-length string, except that first element of the array will need only 11 bytes for storage instead of 20.

0	"Four score\0"
1	"lazy programmers.\0"

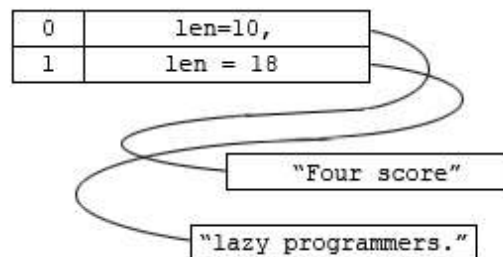

Figure 17. Ways to represent strings

First, a dataset may have a dataset with datatype H5T_NATIVE_CHAR, with each character of the string as an element of the dataset. This will store an unstructured block of text data, but gives little indication of any structure in the text. See item a in the figure above.

A second alternative is to store the data using the datatype class `H5T_STRING`, with each element a fixed length. See item b in the figure above. In this approach, each element might be a word or a sentence, addressed by the dataspace. The dataset reserves space for the specified number of characters, although some strings may be shorter. This approach is simple and usually is fast to access, but can waste storage space if the length of the Strings varies.

A third alternative is to use a variable-length datatype. See item c in the figure above. This can be done using the standard mechanisms described above (e.g., using `H5T_NATIVE_CHAR` instead of `H5T_NATIVE_INT` in Example 25 above). The program would use `vl_t` structures to write and read the data.

A fourth alternative is to use a special feature of the string datatype class to set the size of the datatype to `H5T_VARIABLE`. See item c in the figure above. The example below shows a declaration of a datatype of type `H5T_C_S1` which is set to `H5T_VARIABLE`. The HDF5 Library automatically translates between this and the `vl_t` structure. (Note: the `H5T_VARIABLE` size can only be used with string datatypes.)

```
tid1 = H5Tcopy (H5T_C_S1);
ret = H5Tset_size (tid1, H5T_VARIABLE);
```

Example 29. Set the string datatype size with `H5T_VARIABLE`

Variable-length strings can be read into C strings (i.e., pointers to zero terminated arrays of `char`). See the figure below.

```
char *rdata[SPACE1_DIM1];

ret=H5Dread(dataset, tid1, H5S_ALL, H5S_ALL, xfer_pid, rdata);

for(i=0; i<SPACE1_DIM1; i++) {
    printf("%d: len: %d, str is: %s\n", strlen(rdata[i]),rdata[i]);
}

ret=H5Dvlen_reclaim(tid1, sid1, xfer_pid, rdata);
```

Example 30. Read variable-length strings into C strings

6.5.2. Reference

In HDF5, objects (i.e. groups, datasets, and committed datatypes) are usually accessed by name. There is another way to access stored objects - by reference. There are two reference datatypes: object reference and region reference. Object reference objects are created with `H5Rcreate` and other calls (cross reference). These objects can be stored and retrieved in a dataset as elements with reference datatype. The first example below shows an example of code that creates references to four objects, and then writes the array of object references to a dataset. The second example below shows a dataset of datatype reference being read and one of the reference objects being dereferenced to obtain an object pointer.

In order to store references to regions of a dataset, the datatype should be `H5T_REGION_OBJ`. Note that a data element must be either an object reference or a region reference: these are different types and cannot be mixed within a single array.

A reference datatype cannot be divided for I/O: an element is read or written completely.

```
dataset=H5Dcreate(fid1, "Dataset3", H5T_STD_REF_OBJ, sid1,
                 H5P_DEFAULT, H5P_DEFAULT, H5P_DEFAULT);

/* Create reference to dataset */
ret = H5Rcreate(&wbuf[0], fid1, "/Group1/Dataset1", H5R_OBJECT, -1);

/* Create reference to dataset */
ret = H5Rcreate(&wbuf[1], fid1, "/Group1/Dataset2", H5R_OBJECT, -1);

/* Create reference to group */
ret = H5Rcreate(&wbuf[2], fid1, "/Group1", H5R_OBJECT, -1);

/* Create reference to committed datatype */
ret = H5Rcreate(&wbuf[3], fid1, "/Group1/Datatype1", H5R_OBJECT, -1);

/* Write selection to disk */

ret=H5Dwrite(dataset, H5T_STD_REF_OBJ, H5S_ALL, H5S_ALL, H5P_DEFAULT, wbuf);
```

Example 31. Create object references and write to a dataset

```
rbuf = malloc(sizeof(hobj_ref_t)*SPACE1_DIM1);

/* Read selection from disk */
ret=H5Dread(dataset, H5T_STD_REF_OBJ, H5S_ALL, H5S_ALL, H5P_DEFAULT, rbuf);

/* Open dataset object */
dset2 = H5Rdereference(dataset, H5R_OBJECT, &rbuf[0]);
```

Example 32. Read a dataset with a reference datatype

6.5.3. ENUM

The enum datatype implements a set of (name, value) pairs, similar to C/C++ enum. The values are currently limited to native integer datatypes. Each name can be the name of only one value, and each value can have only one name. There can be up to 2^{16} different names for a given enumeration.

The data elements of the ENUMERATION are stored according to the datatype, e.g., as an array of integers. The example below shows an example of how to create an enumeration with five elements. The elements map symbolic names to 2-byte integers. See the table below.

```
hid_t hdf_en_colors = H5Tcreate(H5T_ENUM, sizeof(short));
short val;
    H5Tenum_insert(hdf_en_colors, "RED", (val=0,&val));
    H5Tenum_insert(hdf_en_colors, "GREEN", (val=1,&val));
    H5Tenum_insert(hdf_en_colors, "BLUE", (val=2,&val));
    H5Tenum_insert(hdf_en_colors, "WHITE", (val=3,&val));
    H5Tenum_insert(hdf_en_colors, "BLACK", (val=4,&val));

    H5Dcreate(fileid, datasetname, hdf_en_colors, spaceid, H5P_DEFAULT,
             H5P_DEFAULT, H5P_DEFAULT);
```

Example 33. Create an enumeration with five elements

Table 22. An enumeration with five elements

Name	Value
RED	0
GREEN	1
BLUE	2
WHITE	3
BLACK	4

The figure below shows how an array of eight values might be stored. Conceptually, the array is an array of symbolic names [BLACK, RED, WHITE, BLUE, ...]. See item a in the figure below. These are stored as the values and are short integers. So, the first 2 bytes are the value associated with “BLACK”, which is the number 4, and so on. See item b in the figure below.

a) Logical data to be written - eight elements

Index	Name
0	:BLACK
1	RED
2	WHITE
3	BLUE
4	RED
5	WHITE
6	BLUE
7	GREEN

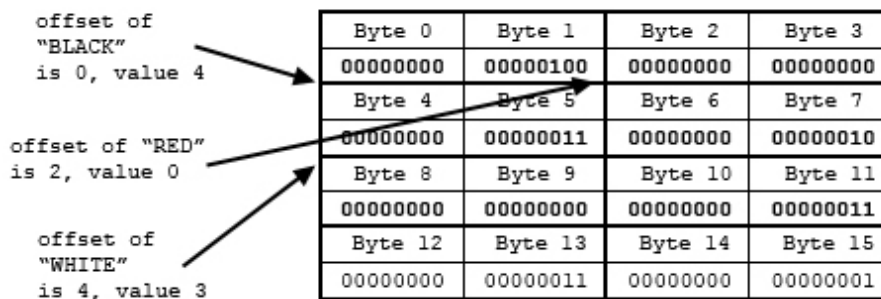

b) The storage layout. Total size of the array is 16 bytes, 2 bytes per element.

Figure 18. Storing an enum array

The order that members are inserted into an enumeration type is unimportant; the important part is the associations between the symbol names and the values. Thus, two enumeration datatypes will be considered equal if and only if both types have the same symbol/value associations and both have equal underlying integer datatypes. Type equality is tested with the `H5Tequal` function.

If a particular architecture type is required, a little-endian or big-endian datatype for example, use a native integer datatype as the ENUM base datatype and use `H5Tconvert` on values as they are read from or written to a dataset.

6.5.4. Opaque

In some cases, a user may have data objects that should be stored and retrieved as blobs with no attempt to interpret them. For example, an application might wish to store an array of encrypted certificates which are 100 bytes long.

While an arbitrary block of data may always be stored as bytes, characters, integers, or whatever, this might mislead programs about the meaning of the data. The opaque datatype defines data elements which are uninterpreted by HDF5. The opaque data may be labeled with `H5Tset_tag` with a string that might be used by an application. For example, the encrypted certificates might have a tag to indicate the encryption and the certificate standard.

6.5.5. Bitfield

Some data is represented as bits, where the number of bits is not an integral byte and the bits are not necessarily interpreted as a standard type. Some examples might include readings from machine registers (e.g., switch positions), a cloud mask, or data structures with several small integers that should be store in a single byte.

This data could be stored as integers, strings, or enumerations. However, these storage methods would likely result in considerable wasted space. For example, storing a cloud mask with one byte per value would use up to eight times the space of a packed array of bits.

The HDF5 bitfield datatype class defines a data element that is a contiguous sequence of bits, which are stored on disk in a packed array. The programming model is the same as for unsigned integers: the datatype object is created by copying a predefined datatype, and then the precision, offset, and padding are set.

While the use of the bitfield datatype will reduce storage space substantially, there will still be wasted space if the bitfield as a whole does not match the 1-, 2-, 4-, or 8-byte unit in which it is written. The remaining unused space can be removed by applying the N-bit filter to the dataset containing the bitfield data.

6.6. Fill Values

The “fill value” for a dataset is the specification of the default value assigned to data elements that have not yet been written. In the case of a dataset with an atomic datatype, the fill value is a single value of the appropriate datatype, such as ‘0’ or ‘-1.0’. In the case of a dataset with a composite datatype, the fill value is a single data element of the appropriate type. For example, for an array or compound datatype, the fill value is a single data element with values for all the component elements of the array or compound datatype.

The fill value is set (permanently) when the dataset is created. The fill value is set in the dataset creation properties in the `H5Dcreate` call. Note that the `H5Dcreate` call must also include the datatype of the dataset, and the value provided for the fill value will be interpreted as a single element of this datatype. The example below shows code which creates a dataset of integers with fill value -1. Any unwritten data elements will be set to -1.

```
hid_t      plist_id;
int filler;

filler = -1;
plist_id = H5Pcreate(H5P_DATASET_CREATE);
H5Pset_fill_value(plist_id, H5T_NATIVE_INT, &filler);

/* Create the dataset with fill value '-1'. */
dataset_id = H5Dcreate(file_id, "/dset", H5T_STD_I32BE,
                      dataspace_id, H5P_DEFAULT, plist_id, H5P_DEFAULT);
```

Example 34. Create a dataset with a fill value of -1

```
typedef struct s1_t {
    int    a;
    char  b;
    double c;
} s1_t;
s1_t      filler;

s1_t tid = H5Tcreate (H5T_COMPOUND, sizeof(s1_t));
H5Tinsert(s1_t tid, "a_name", HOFFSET(s1_t, a), H5T_NATIVE_INT);
H5Tinsert(s1_t tid, "b_name", HOFFSET(s1_t, b), H5T_NATIVE_CHAR);
H5Tinsert(s1_t tid, "c_name", HOFFSET(s1_t, c), H5T_NATIVE_DOUBLE);

filler.a = -1;
filler.b = '*';
filler.c = -2.0;

plist_id = H5Pcreate(H5P_DATASET_CREATE);
H5Pset_fill_value(plist_id, s1_t tid, &filler);

/* Create the dataset with fill value (-1, '*', -2.0). */
dataset = H5Dcreate(file, datasetname, s1_t tid, space, H5P_DEFAULT,
                   plist_id, H5P_DEFAULT);
```

Example 35. Create a fill value for a compound datatype

The figure above shows how to create a fill value for a compound datatype. The procedure is the same as the previous example except the filler must be a structure with the correct fields. Each field is initialized to the

desired fill value.

The fill value for a dataset can be retrieved by reading the dataset creation properties of the dataset and then by reading the fill value with `H5Pget_fill_value`. The data will be read into memory using the storage layout specified by the datatype. This transfer will convert data in the same way as `H5Dread`. The figure below shows how to get the fill value from the dataset created in Example 33 above.

```
hid_t plist2;
int filler;

dataset_id = H5Dopen(file_id, "/dset", H5P_DEFAULT);
plist2 = H5Dget_create_plist(dataset_id);

H5Pget_fill_value(plist2, H5T_NATIVE_INT, &filler);

/* filler has the fill value, '-1' */
```

Example 36. Retrieve a fill value

A similar procedure is followed for any datatype. The example below shows how to read the fill value for the compound datatype created in an example above. Note that the program must pass an element large enough to hold a fill value of the datatype indicated by the argument to `H5Pget_fill_value`. Also, the program must understand the datatype in order to interpret its components. This may be difficult to determine without knowledge of the application that created the dataset.

```
char *      fillbuf;
int sz;
dataset = H5Dopen( file, DATASETNAME, H5P_DEFAULT);

s1_tid = H5Dget_type(dataset);

sz = H5Tget_size(s1_tid);

fillbuf = (char *)malloc(sz);

plist_id = H5Dget_create_plist(dataset);

H5Pget_fill_value(plist_id, s1_tid, fillbuf);

printf("filler.a: %d\n", ((s1_t *) fillbuf)->a);
printf("filler.b: %c\n", ((s1_t *) fillbuf)->b);
printf("filler.c: %f\n", ((s1_t *) fillbuf)->c);
```

Example 37. Read the fill value for a compound datatype

6.7. Complex Combinations of Datatypes

Several composite datatype classes define collections of other datatypes, including other composite datatypes. In general, a datatype can be nested to any depth, with any combination of datatypes.

For example, a compound datatype can have members that are other compound datatypes, arrays, VL datatypes. An array can be an array of array, an array of compound, or an array of VL. And a VL datatype can be a variable-length array of compound, array, or VL datatypes.

These complicated combinations of datatypes form a logical tree, with a single root datatype, and leaves which must be atomic datatypes (predefined or user-defined). The figure below shows an example of a logical tree describing a compound datatype constructed from different datatypes.

Recall that the datatype is a description of the layout of storage. The complicated compound datatype is constructed from component datatypes, each of which describe the layout of part of the storage. Any datatype can be used as a component of a compound datatype, with the following restrictions:

1. No byte can be part of more than one component datatype (i.e., the fields cannot overlap within the compound datatype)
2. The total size of the components must be less than or equal to the total size of the compound datatype

These restrictions are essentially the rules for C structures and similar record types familiar from programming languages. Multiple typing, such as a C union, is not allowed in HDF5 datatypes.

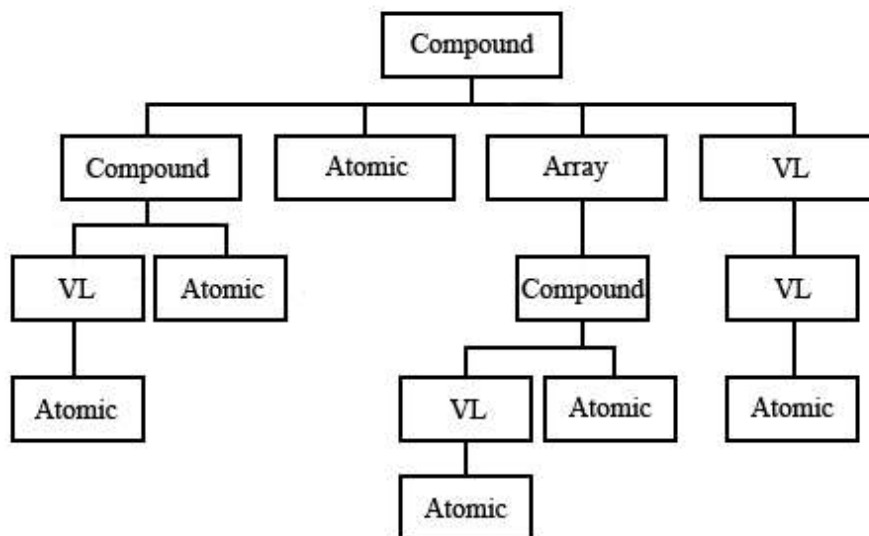

Figure 19. A compound datatype built with different datatypes

6.7.1. Creating a Complicated Compound Datatype

To construct a complicated compound datatype, each component is constructed, and then added to the enclosing datatype description. The example below shows how to create a compound datatype with four members:

- “T1”, a compound datatype with three members
- “T2”, a compound datatype with two members
- “T3”, a one-dimensional array of integers
- “T4”, a string

Below the example code is a figure that shows this datatype as a logical tree. The output of the *h5dump* utility is shown in the example below the figure.

Each datatype is created as a separate datatype object. Figure 20 below shows the storage layout for the four individual datatypes. Then the datatypes are inserted into the outer datatype at an appropriate offset. Figure 21 below shows the resulting storage layout. The combined record is 89 bytes long.

The Dataset is created using the combined compound datatype. The dataset is declared to be a 4 by 3 array of compound data. Each data element is an instance of the 89-byte compound datatype. Figure 22 below shows the layout of the dataset, and expands one of the elements to show the relative position of the component data elements.

Each data element is a compound datatype, which can be written or read as a record, or each field may be read or written individually. The first field (“T1”) is itself a compound datatype with three fields (“T1.a”, “T1.b”, and “T1.c”). “T1” can be read or written as a record, or individual fields can be accessed. Similarly, the second field is a compound datatype with two fields (“T2.f1”, “T2.f2”).

The third field (“T3”) is an array datatype. Thus, “T3” should be accessed as an array of 40 integers. Array data can only be read or written as a single element, so all 40 integers must be read or written to the third field. The fourth field (“T4”) is a single string of length 25.

```

typedef struct s1_t {
    int    a;
    char  b;
    double c;
} s1_t;

typedef struct s2_t {
    float f1;
    float f2;
} s2_t;
hid_t    s1_tid, s2_tid, s3_tid, s4_tid, s5_tid;

/* Create a datatype for s1 */
s1_tid = H5Tcreate (H5T_COMPOUND, sizeof(s1_t));
H5Tinsert(s1_tid, "a_name", HOFFSET(s1_t, a), H5T_NATIVE_INT);
H5Tinsert(s1_tid, "b_name", HOFFSET(s1_t, b), H5T_NATIVE_CHAR);
H5Tinsert(s1_tid, "c_name", HOFFSET(s1_t, c), H5T_NATIVE_DOUBLE);

/* Create a datatype for s2. */
s2_tid = H5Tcreate (H5T_COMPOUND, sizeof(s2_t));
H5Tinsert(s2_tid, "f1", HOFFSET(s2_t, f1), H5T_NATIVE_FLOAT);
H5Tinsert(s2_tid, "f2", HOFFSET(s2_t, f2), H5T_NATIVE_FLOAT);

/* Create a datatype for an Array of integers */
s3_tid = H5Tarray_create(H5T_NATIVE_INT, RANK, dim);

/* Create a datatype for a String of 25 characters */
s4_tid = H5Tcopy(H5T_C_S1);
H5Tset_size(s4_tid, 25);

/*
 * Create a compound datatype composed of one of each of these
 * types.
 * The total size is the sum of the size of each.
 */

sz = H5Tget_size(s1_tid) + H5Tget_size(s2_tid) + H5Tget_size(s3_tid)
    + H5Tget_size(s4_tid);

s5_tid = H5Tcreate (H5T_COMPOUND, sz);

/* insert the component types at the appropriate offsets */

H5Tinsert(s5_tid, "T1", 0, s1_tid);
H5Tinsert(s5_tid, "T2", sizeof(s1_t), s2_tid);
H5Tinsert(s5_tid, "T3", sizeof(s1_t)+sizeof(s2_t), s3_tid);
H5Tinsert(s5_tid, "T4", (sizeof(s1_t) +sizeof(s2_t)+
    H5Tget_size(s3_tid)), s4_tid);

/*
 * Create the dataset with this datatype.
 */
dataset = H5Dcreate(file, DATASETNAME, s5_tid, space, H5P_DEFAULT,
    H5P_DEFAULT, H5P_DEFAULT);

```

Example 38. Create a compound datatype with four members

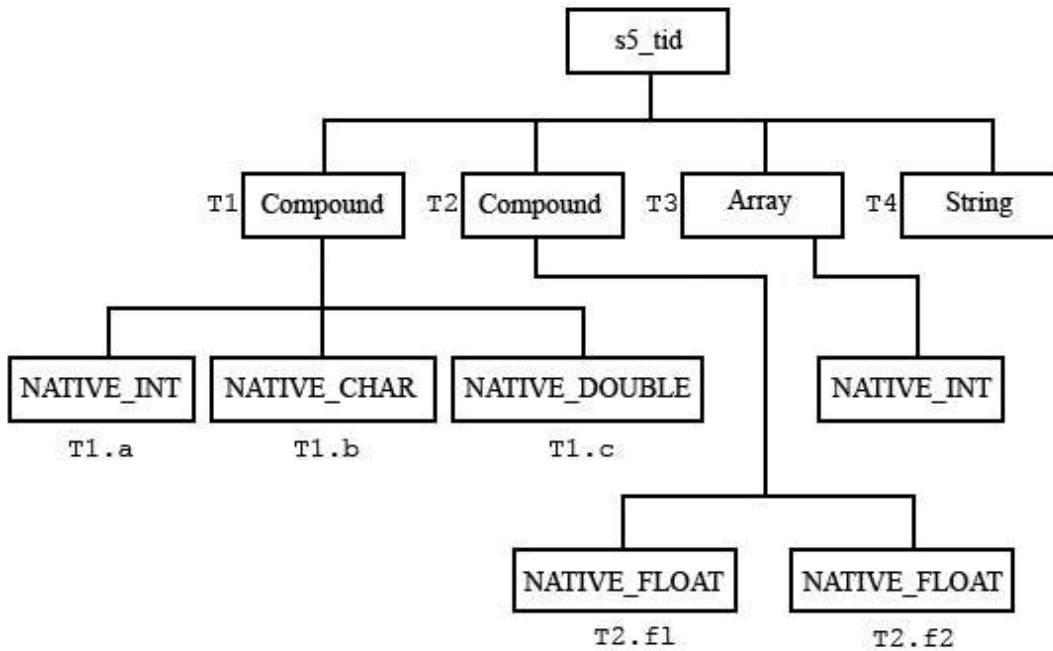

Figure 19. Logical tree for the compound datatype with four members

```

DATATYPE H5T_COMPOUND {
  H5T_COMPOUND {
    H5T_STD_I32LE "a_name";
    H5T_STD_I8LE "b_name";
    H5T_IEEE_F64LE "c_name";
  } "T1";
  H5T_COMPOUND {
    H5T_IEEE_F32LE "f1";
    H5T_IEEE_F32LE "f2";
  } "T2";
  H5T_ARRAY { [10] H5T_STD_I32LE } "T3";
  H5T_STRING {
    STRSIZE 25;
    STRPAD H5T_STR_NULLTERM;
    CSET H5T_CSET_ASCII;
    CTYPE H5T_C_S1;
  } "T4";
}

```

Example 39. Output from h5dump for the compound datatype

a) Compound type 's1_t', size 16 bytes.

Byte 0	Byte 1	Byte 2	Byte 3
aaaaaaaa	aaaaaaaa	aaaaaaaa	aaaaaaaa
Byte 4	Byte 5	Byte 6	Byte 7
bbbbbbbb			
Byte 8	Byte 9	Byte 10	Byte 11
cccccccc	cccccccc	cccccccc	cccccccc
Byte 12	Byte 13	Byte 14	Byte 15
cccccccc	cccccccc	cccccccc	cccccccc

b) Compound type 's2_t', size 8 bytes.

Byte 0	Byte 1	Byte 2	Byte 3
ffffffff	ffffffff	ffffffff	ffffffff
Byte 4	Byte 5	Byte 6	Byte 7
gggggggg	gggggggg	gggggggg	gggggggg

c) Array type 's3_tid', 40 integers, total size 40 bytes.

Byte 0	Byte 1	Byte 2	Byte 3
00000000	00000000	00000000	00000000
Byte 4	Byte 5	Byte 6	Byte 7
00000000	00000000	00000000	00000001

...

Byte 36	Byte 37	Byte 38	Byte 39
00000000	00000000	00000000	00001010

d) String type 's4_tid', size 25 bytes.

Byte 0	Byte 1	Byte 2	Byte 3
'a'	'b'	'c'	'd'

...

Byte 24	Byte 25	Byte 26	Byte 27
00000000			

Figure 20. The storage layout for the four member datatypes

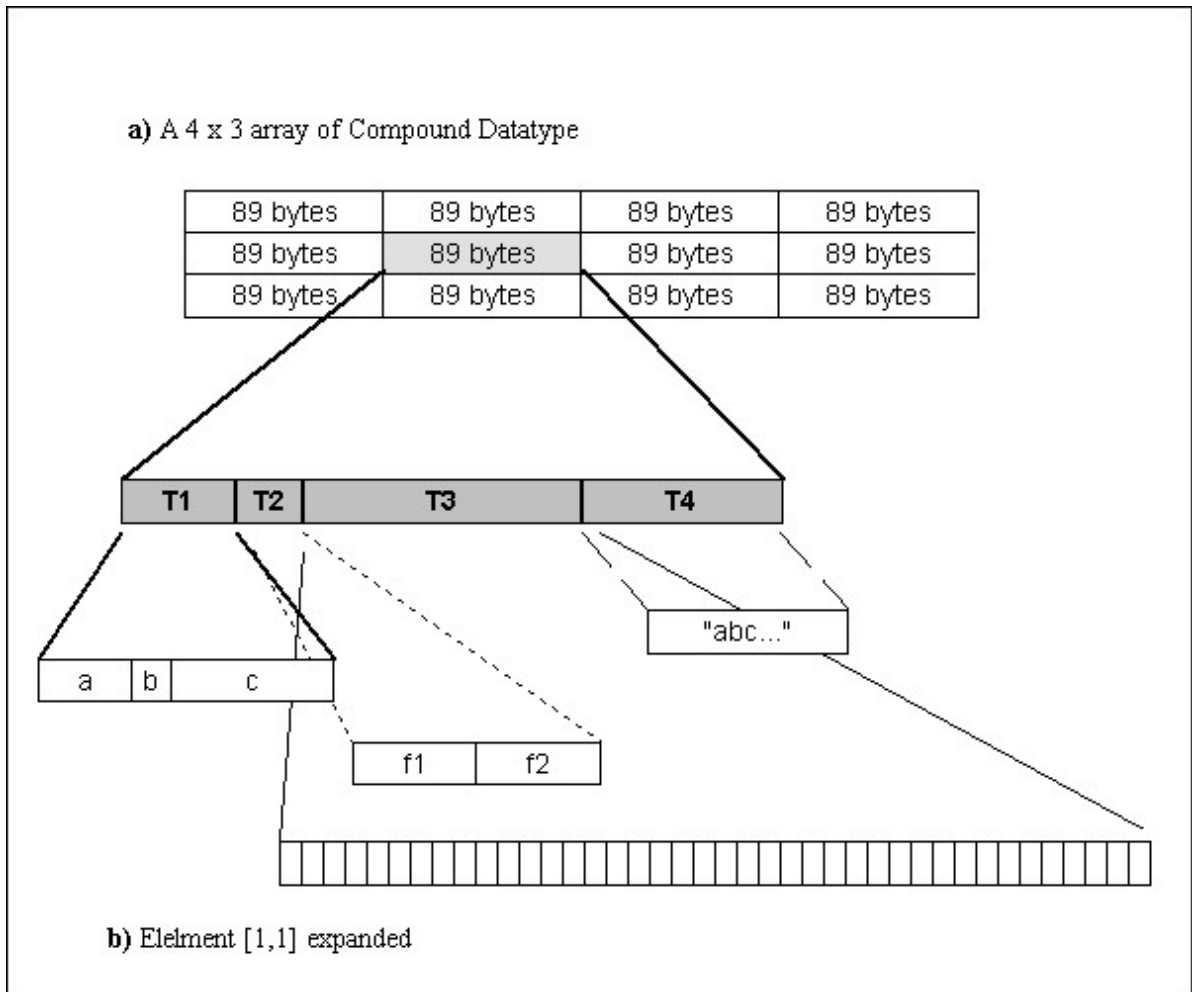

Figure 22. The layout of the dataset

6.7.2. Analyzing and Navigating a Compound Datatype

A complicated compound datatype can be analyzed piece by piece to discover the exact storage layout. In the example above, the outer datatype is analyzed to discover that it is a compound datatype with four members. Each member is analyzed in turn to construct a complete map of the storage layout.

The example below shows an example of code that partially analyzes a nested compound datatype. The name and overall offset and size of the component datatype is discovered, and then its type is analyzed depending on the datatype class. Through this method, the complete storage layout can be discovered.

```
s1_tid = H5Dget_type(dataset);

if (H5Tget_class(s1_tid) == H5T_COMPOUND) {
    printf("COMPOUND DATATYPE {\n");
    sz = H5Tget_size(s1_tid);
    nmemb = H5Tget_nmembers(s1_tid);
    printf("  %d bytes\n",sz);
    printf("  %d members\n",nmemb);
    for (i =0; i < nmemb; i++) {
        s2_tid = H5Tget_member_type(s1_tid, i);
        if (H5Tget_class(s2_tid) == H5T_COMPOUND) {
            /* recursively analyze the nested type. */

        } else if (H5Tget_class(s2_tid) == H5T_ARRAY) {
            sz2 = H5Tget_size(s2_tid);
            printf("  %s: NESTED ARRAY DATATYPE offset %d size %d {\n",
                H5Tget_member_name(s1_tid, i),
                H5Tget_member_offset(s1_tid, i),
                sz2);
            H5Tget_array_dims(s2_tid, dim);
            s3_tid = H5Tget_super(s2_tid);
            /* Etc., analyze the base type of the array */
        } else {
            /* analyze a simple type */
            printf("    %s: type code %d offset %d size %d\n",
                H5Tget_member_name(s1_tid, i),
                H5Tget_class(s2_tid),
                H5Tget_member_offset(s1_tid, i),
                H5Tget_size(s2_tid));
        }
    }
    /* and so on . */
}
```

Example 40. Analyzing a compound datatype and its members

6.8. Life Cycle of the Datatype Object

Application programs access HDF5 datatypes through identifiers. Identifiers are obtained by creating a new datatype or by copying or opening an existing datatype. The identifier can be used until it is closed or until the library shuts down. See items a and b in the figure below. By default, a datatype is *transient*, and it disappears when it is closed.

When a dataset or attribute is created (`H5Dcreate` or `H5Acreate`), its datatype is stored in the HDF5 file as part of the dataset or attribute object. See item c in the figure below. Once an object created, its datatype cannot be changed or deleted. The datatype can be accessed by calling `H5Dget_type`, `H5Aget_type`, `H5Tget_super`, or `H5Tget_member_type`. See item d in the figure below. These calls return an identifier to a *transient* copy of the datatype of the dataset or attribute unless the datatype is a committed datatype.

Note that when an object is created, the stored datatype is a copy of the transient datatype. If two objects are created with the same datatype, the information is stored in each object with the same effect as if two different datatypes were created and used.

A transient datatype can be stored using `H5Tcommit` in the HDF5 file as an independent, named object, called a committed datatype. Committed datatypes were formerly known as named datatypes. See item e in the figure below. Subsequently, when a committed datatype is opened with `H5Topen` (item f), or is obtained with `H5Tget_type` or similar call (item k), the return is an identifier to a transient copy of the stored datatype. The identifier can be used in the same way as other datatype identifiers except that the committed datatype cannot be modified. When a committed datatype is copied with `H5Tcopy`, the return is a new, modifiable, transient datatype object (item f).

When an object is created using a committed datatype (`H5Dcreate`, `H5Acreate`), the stored datatype is used without copying it to the object. See item j in the figure below. In this case, if multiple objects are created using the same committed datatype, they all share the exact same datatype object. This saves space and makes clear that the datatype is shared. Note that a committed datatype can be shared by objects within the same HDF5 file, but not by objects in other files.

A committed datatype can be deleted from the file by calling `H5Ldelete` which replaces `H5Gunlink`. See item i in the figure below. If one or more objects are still using the datatype, the committed datatype cannot be accessed with `H5Topen`, but will not be removed from the file until it is no longer used. `H5Tget_type` and similar calls will return a transient copy of the datatype.

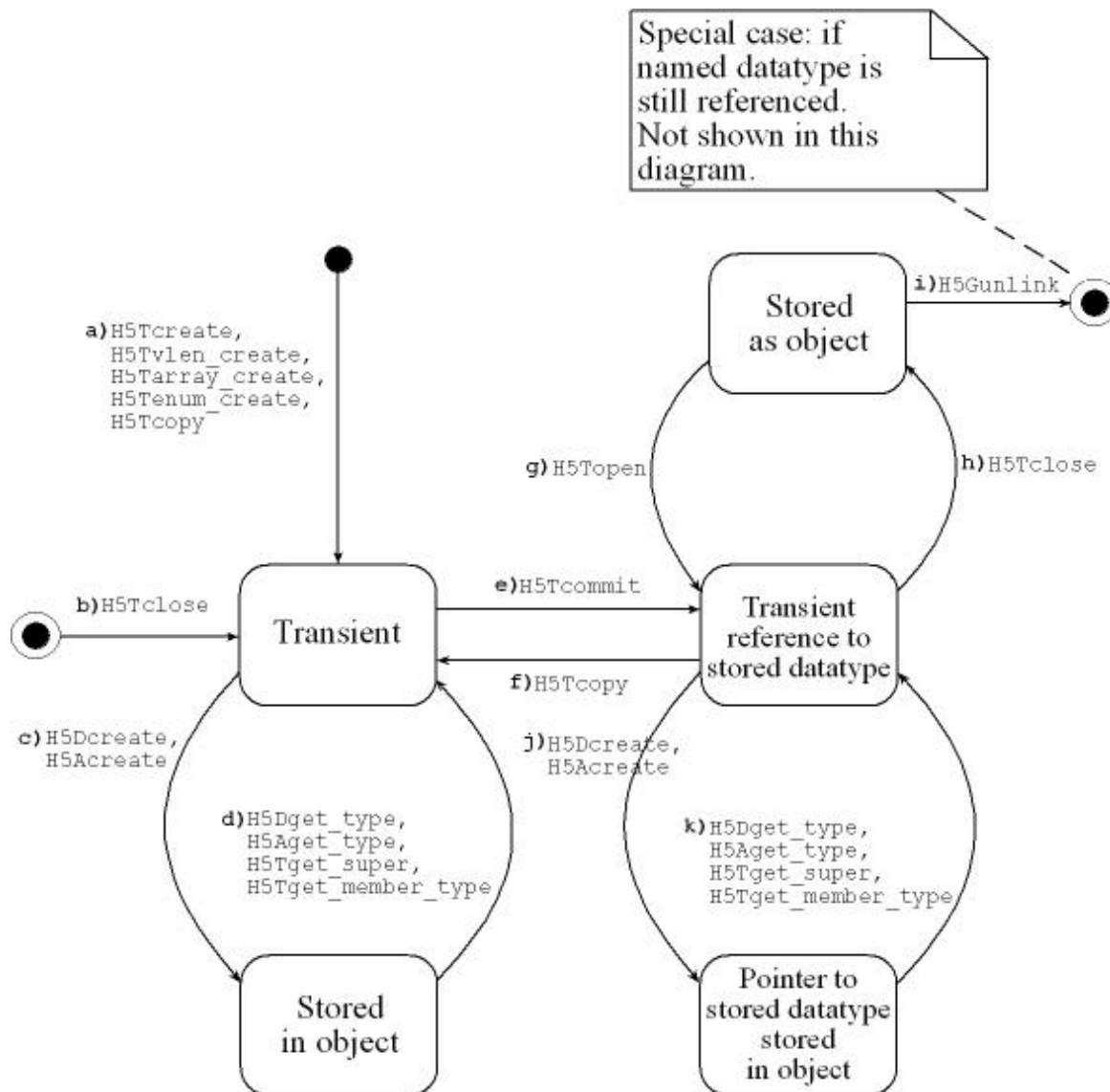

Figure 23. Life cycle of a datatype

Transient datatypes are initially modifiable. Note that when a datatype is copied or when it is written to the file (when an object is created) or the datatype is used to create a composite datatype, a copy of the current state of the datatype is used. If the datatype is then modified, the changes have no effect on datasets, attributes, or datatypes that have already been created. See the figure below.

A transient datatype can be made *read-only* (`H5Tlock`). Note that the datatype is still transient, and otherwise does not change. A datatype that is *immutable* is *read-only* but cannot be closed except when the entire library is closed. The predefined types such as `H5T_NATIVE_INT` are *immutable transient* types.

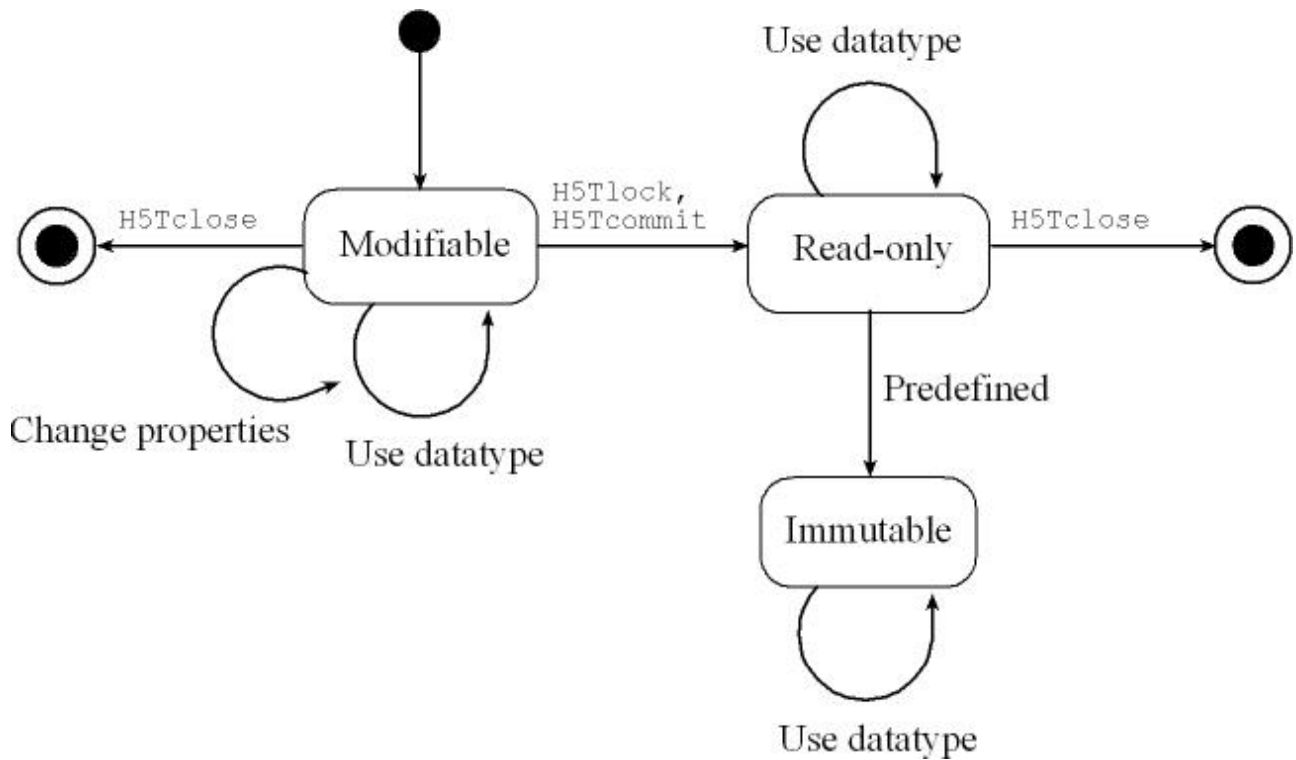

Figure 24. Transient datatype states: modifiable, read-only, and immutable

To create two or more datasets that share a common datatype, first commit the datatype, and then use that datatype to create the datasets. See the example below.

```
hid_t t1 = ...some transient type...;
H5Tcommit (file, "shared_type", t1, H5P_DEFAULT, H5P_DEFAULT,
           H5P_DEFAULT);
hid_t dset1 = H5Dcreate (file, "dset1", t1, space, H5P_DEFAULT,
                        H5P_DEFAULT, H5P_DEFAULT);
hid_t dset2 = H5Dcreate (file, "dset2", t1, space, H5P_DEFAULT,
                        H5P_DEFAULT, H5P_DEFAULT);

hid_t dset1 = H5Dopen (file, "dset1", H5P_DEFAULT);
hid_t t2 = H5Dget_type (dset1);
hid_t dset3 = H5Dcreate (file, "dset3", t2, space, H5P_DEFAULT,
                        H5P_DEFAULT, H5P_DEFAULT);
hid_t dset4 = H5Dcreate (file, "dset4", t2, space, H5P_DEFAULT,
                        H5P_DEFAULT, H5P_DEFAULT);
```

Example 41. Create a shareable datatype

Table 23. Datatype APIs

Function	Description
<code>hid_t H5Topen (hid_t location, const char *name)</code>	A committed datatype can be opened by calling this function, which returns a datatype identifier. The identifier should eventually be released by calling <code>H5Tclose()</code> to release resources. The committed datatype returned by this function is read-only or a negative value is returned for failure. The location is either a file or group identifier.
<code>herr_t H5Tcommit (hid_t location, const char *name, hid_t type, H5P_DEFAULT, H5P_DEFAULT, H5P_DEFAULT)</code>	A transient datatype (not immutable) can be written to a file and turned into a committed datatype by calling this function. The location is either a file or group identifier and when combined with name refers to a new committed datatype.
<code>htri_t H5Tcommitted (hid_t type)</code>	A type can be queried to determine if it is a committed type or a transient type. If this function returns a positive value then the type is committed. Datasets which return committed datatypes with <code>H5Dget_type()</code> are able to share the datatype with other datasets in the same file.

6.9. Data Transfer: Datatype Conversion and Selection

When data is transferred (write or read), the storage layout of the data elements may be different. For example, an integer might be stored on disk in big-endian byte order and read into memory with little-endian byte order. In this case, each data element will be transformed by the HDF5 Library during the data transfer.

The conversion of data elements is controlled by specifying the datatype of the source and specifying the intended datatype of the destination. The storage format on disk is the datatype specified when the dataset is created. The datatype of memory must be specified in the library call.

In order to be convertible, the datatype of the source and destination must have the same datatype class. Thus, integers can be converted to other integers, and floats to other floats, but integers cannot (yet) be converted to floats. For each atomic datatype class, the possible conversions are defined.

Basically, any datatype can be converted to another datatype of the same datatype class. The HDF5 Library automatically converts all properties. If the destination is too small to hold the source value then an overflow or underflow exception occurs. If a handler is defined with the `H5Pset_type_conv_cb` function, it will be called. Otherwise, a default action will be performed. The table below summarizes the default actions.

Table 24. Default actions for datatype conversion exceptions

Datatype Class	Possible Exceptions	Default Action
Integer	Size, offset, pad	
Float	Size, offset, pad, ebits, etc.	
String	Size	Truncates, zero terminate if required.
Enumeration	No field	All bits set

For example, when reading data from a dataset, the source datatype is the datatype set when the dataset was created, and the destination datatype is the description of the storage layout in memory. The destination datatype must be specified in the `H5Dread` call. The example below shows an example of reading a dataset of 32-bit integers. The figure below the example shows the data transformation that is performed.

```
/* Stored as H5T_STD_BE32 */
/* Use the native memory order in the destination */
mem_type_id = H5Tcopy(H5T_NATIVE_INT);
status = H5Dread(dataset_id, mem_type_id, mem_space_id,
                file_space_id, xfer_plist_id, buf );
```

Example 42. Specify the destination datatype with `H5Dread`

Source Datatype: H5T_STD_BE32

Byte 0	Byte 1	Byte 2	Byte 3
aaaaaaaa	bbbbbbbb	cccccccc	dddddddd
Byte 4	Byte 5	Byte 6	Byte 7
wwwwwww	xxxxxxxx	yyyyyyyy	zzzzzzzz

....



Automatically byte swapped
during the H5Dread

Destination Datatype: H5T_STD_LE32

Byte 0	Byte 1	Byte 2	Byte 3
bbbbbbbb	aaaaaaaa	dddddddd	cccccccc
Byte 4	Byte 5	Byte 6	Byte 7
xxxxxxxx	wwwwwww	zzzzzzzz	yyyyyyyy

....

Figure 25. Layout of a datatype conversion

One thing to note in the example above is the use of the predefined native datatype `H5T_NATIVE_INT`. Recall that in this example, the data was stored as a 4-bytes in big-endian order. The application wants to read this data into an array of integers in memory. Depending on the system, the storage layout of memory might be either big or little-endian, so the data may need to be transformed on some platforms and not on others. The `H5T_NATIVE_INT` type is set by the HDF5 Library to be the correct type to describe the storage layout of the memory on the system. Thus, the code in the example above will work correctly on any platform, performing a transformation when needed.

There are predefined native types for most atomic datatypes, and these can be combined in composite datatypes. In general, the predefined native datatypes should always be used for data stored in memory.

Predefined native datatypes describe
the storage properties of memory.

For composite datatypes, the component atomic datatypes will be converted. For a variable-length datatype, the source and destination must have compatible base datatypes. For a fixed-size string datatype, the length and padding of the strings will be converted. Variable-length strings are converted as variable-length datatypes.

For an array datatype, the source and destination must have the same rank and dimensions, and the base datatype must be compatible. For example an array datatype of 4 x 3 32-bit big-endian integers can be transferred to an array datatype of 4 x 3 little-endian integers, but not to a 3 x 4 array.

For an enumeration datatype, data elements are converted by matching the symbol names of the source and destination datatype. The figure below shows an example of how two enumerations with the same names and different values would be converted. The value '2' in the source dataset would be converted to '0x0004' in the destination.

If the source data stream contains values which are not in the domain of the conversion map then an overflow exception is raised within the library.

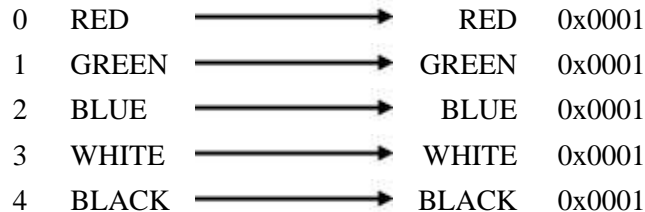

Figure 26. An enum datatype conversion

For compound datatypes, each field of the source and destination datatype is converted according to its type. The name and order of the fields must be the same in the source and the destination but the source and destination may have different alignments of the fields, and only some of the fields might be transferred.

The example below shows the compound datatypes shows sample code to create a compound datatype with the fields aligned on word boundaries (`s1_tid`) and with the fields packed (`s2_tid`). The former is suitable as a description of the storage layout in memory, the latter would give a more compact store on disk. These types can be used for transferring data, with `s2_tid` used to create the dataset, and `s1_tid` used as the memory datatype.

```
typedef struct s1_t {
    int    a;
    char   b;
    double c;
} s1_t;

s1_tid = H5Tcreate (H5T_COMPOUND, sizeof(s1_t));
H5Tinsert(s1_tid, "a_name", HOFFSET(s1_t, a), H5T_NATIVE_INT);
H5Tinsert(s1_tid, "b_name", HOFFSET(s1_t, b), H5T_NATIVE_CHAR);
H5Tinsert(s1_tid, "c_name", HOFFSET(s1_t, c), H5T_NATIVE_DOUBLE);

s2_tid = H5Tcopy(s1_tid);
H5Tpack(s2_tid);
```

Example 43. Create an aligned and packed compound datatype

When the data is transferred, the fields within each data element will be aligned according to the datatype specification. The figure below shows how one data element would be aligned in memory and on disk. Note that the size and byte order of the elements might also be converted during the transfer.

It is also possible to transfer some of the fields of compound datatypes. Based on the example above, the example below shows a compound datatype that selects the first and third fields of the `s1_tid`. The second datatype can be used as the memory datatype, in which case data is read from or written to these two fields, while skipping the middle field. The second figure below shows the layout for two data elements.

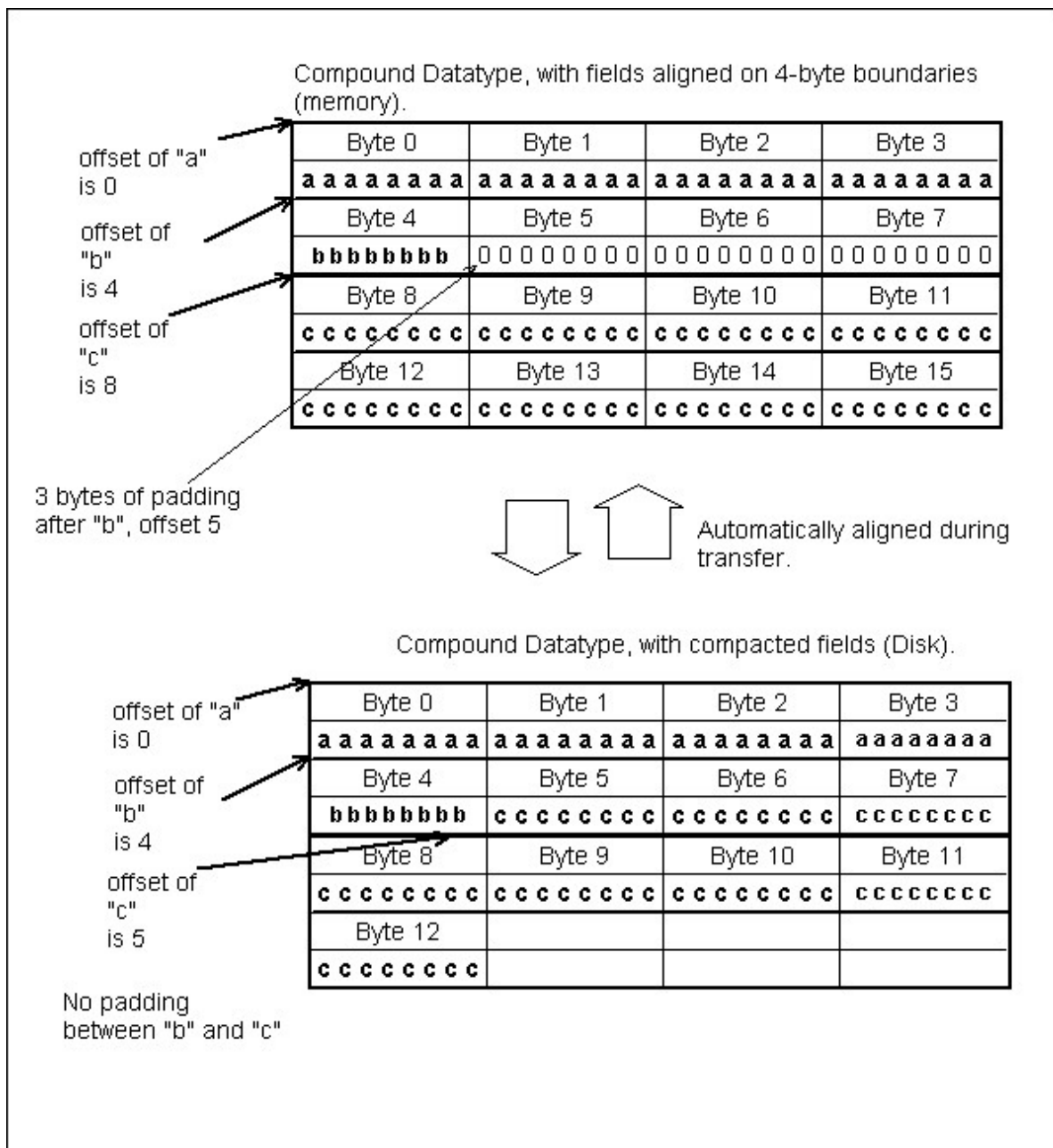

Figure 27. Alignment of a compound datatype

```
typedef struct s1_t {
    int    a;
    char  b;
    double c;
} s1_t;

typedef struct s2_t { /* two fields from s1_t */
    int    a;
    double c;
} s2_t;

s1_tid = H5Tcreate (H5T_COMPOUND, sizeof(s1_t));
H5Tinsert(s1_tid, "a_name", HOFFSET(s1_t, a), H5T_NATIVE_INT);
H5Tinsert(s1_tid, "b_name", HOFFSET(s1_t, b), H5T_NATIVE_CHAR);
H5Tinsert(s1_tid, "c_name", HOFFSET(s1_t, c), H5T_NATIVE_DOUBLE);

s2_tid = H5Tcreate (H5T_COMPOUND, sizeof(s2_t));
H5Tinsert(s1_tid, "a_name", HOFFSET(s2_t, a), H5T_NATIVE_INT);
H5Tinsert(s1_tid, "c_name", HOFFSET(s2_t, c), H5T_NATIVE_DOUBLE);
```

Example 44. Transfer some fields of a compound datatype

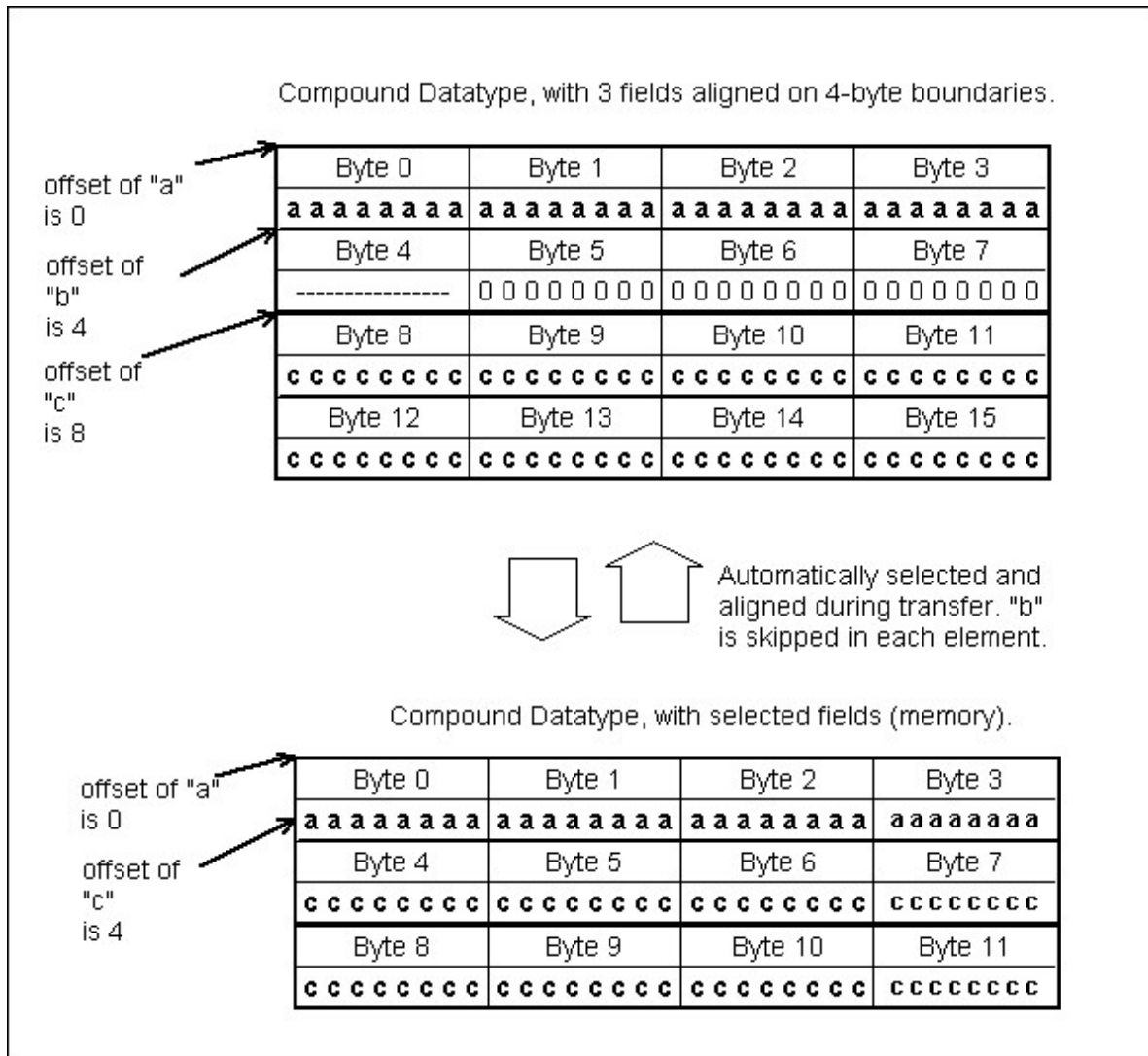

Figure 28. Layout when an element is skipped

6.10. Text Descriptions of Datatypes: Conversion to and from

HDF5 provides a means for generating a portable and human-readable text description of a datatype and for generating a datatype from such a text description. This capability is particularly useful for creating complex datatypes in a single step, for creating a text description of a datatype for debugging purposes, and for creating a portable datatype definition that can then be used to recreate the datatype on many platforms or in other applications.

These tasks are handled by two functions provided in the HDF5 high-level library (H5HL):

`H5LTtext_to_dtype` Creates an HDF5 datatype in a single step.

`H5LTdtype_to_text` Translates an HDF5 datatype into a text description.

Note that this functionality requires that the HDF5 High-Level Library (H5LT) be installed.

While `H5LTtext_to_dtype` can be used to generate any sort of datatype, it is particularly useful for complex datatypes.

`H5LTdtype_to_text` is most likely to be used in two sorts of situations: when a datatype must be closely examined for debugging purpose or to create a portable text description of the datatype that can then be used to recreate the datatype on other platforms or in other applications.

These two functions work for all valid HDF5 datatypes except time, bitfield, and reference datatypes.

The currently supported text format used by `H5LTtext_to_dtype` and `H5LTdtype_to_text` is the data description language (DDL) and conforms to the *HDF5 DDL*. The portion of the *HDF5 DDL* that defines HDF5 datatypes appears below.

```

<datatype> ::= <atomic_type> | <compound_type> | <array_type> |
               <variable_length_type>

<atomic_type> ::= <integer> | <float> | <time> | <string> |
                  <bitfield> | <opaque> | <reference> | <enum>

<integer> ::=  H5T_STD_I8BE      | H5T_STD_I8LE      |
                H5T_STD_I16BE   | H5T_STD_I16LE   |
                H5T_STD_I32BE   | H5T_STD_I32LE   |
                H5T_STD_I64BE   | H5T_STD_I64LE   |
                H5T_STD_U8BE    | H5T_STD_U8LE    |
                H5T_STD_U16BE   | H5T_STD_U16LE   |
                H5T_STD_U32BE   | H5T_STD_U32LE   |
                H5T_STD_U64BE   | H5T_STD_U64LE   |
                H5T_NATIVE_CHAR | H5T_NATIVE_UCHAR |
                H5T_NATIVE_SHORT | H5T_NATIVE_USHORT |
                H5T_NATIVE_INT  | H5T_NATIVE_UINT  |
                H5T_NATIVE_LONG  | H5T_NATIVE_ULONG |
                H5T_NATIVE_LLONG | H5T_NATIVE_ULLONG

<float> ::=  H5T_IEEE_F32BE   | H5T_IEEE_F32LE   |
              H5T_IEEE_F64BE   | H5T_IEEE_F64LE   |
              H5T_NATIVE_FLOAT | H5T_NATIVE_DOUBLE |
              H5T_NATIVE_LDOUBLE

<time> ::= TBD

```

```

<string> ::= H5T_STRING { STRSIZE <strsize> ;
  STRPAD <strpad> ;
  CSET <cset> ;
  CTYPE <ctype> ;}

<strsize> ::= <int_value> | H5T_VARIABLE
<strpad> ::= H5T_STR_NULLTERM | H5T_STR_NULLPAD | H5T_STR_SPACEPAD
<cset> ::= H5T_CSET_ASCII | H5T_CSET_UTF8
<ctype> ::= H5T_C_S1 | H5T_FORTRAN_S1

<bitfield> ::= TBD

<opaque> ::= H5T_OPAQUE { OPQ_SIZE <opq_size>;
  OPQ_TAG <opq_tag>; }
opq_size ::= <int_value>
opq_tag ::= "<string>"

<reference> ::= Not supported

<compound_type> ::= H5T_COMPOUND { <member_type_def>+ }
<member_type_def> ::= <datatype> <field_name> <offset>opt ;
<field_name> ::= "<identifier>"
<offset> ::= : <int_value>

<variable_length_type> ::= H5T_VLEN { <datatype> }

<array_type> ::= H5T_ARRAY { <dim_sizes> <datatype> }
<dim_sizes> ::= [<dim_size>] | [<dim_size>] <dim_sizes>
<dim_size> ::= <int_value>

<enum> ::= H5T_ENUM { <enum_base_type>; <enum_def>+ }
<enum_base_type> ::= <integer>
// Currently enums can only hold integer type data, but they may be
//expanded in the future to hold any datatype
<enum_def> ::= <enum_symbol> <enum_val>;
<enum_symbol> ::= "<identifier>"
<enum_val> ::= <int_value>

```

Example 45. The definition of HDF5 datatypes from the *HDF5 DDL*

The definitions of opaque and compound datatype above are revised for HDF5 Release 1.8. In Release 1.6.5. and earlier, they were defined as follows:

```

<opaque> ::= H5T_OPAQUE { <identifier> }

<compound_type> ::= H5T_COMPOUND { <member_type_def>+ }
<member_type_def> ::= <datatype> <field_name> ;
<field_name> ::= <identifier>

```

Example 46. Old definitions of the opaque and compound datatypes

Examples

The code sample below illustrates the use of `H5LTtext_to_dtype` to generate a variable-length string datatype.

```
hid_t  dtype;
if((dtype = H5LTtext_to_dtype("H5T_STRING {
                                STRSIZE H5T_VARIABLE;
                                STRPAD H5T_STR_NULLPAD;
                                CSET H5T_CSET_ASCII;
                                CTYPE H5T_C_S1;
                                }", H5LT_DDL))<0)
    goto out;
```

Example 47. Creating a variable-length string datatype from a text description

The code sample below illustrates the use of `H5LTtext_to_dtype` to generate a complex array datatype.

```
hid_t  dtype;
if((dtype = H5LTtext_to_dtype("H5T_ARRAY { [5][7][13] H5T_ARRAY
                                { [17][19] H5T_COMPOUND
                                {
                                    H5T_STD_I8BE
                                    \"arr_compound_1\";
                                    H5T_STD_I32BE
                                    \"arr_compound_2\";
                                }
                                }
                                }", H5LT_DDL))
```

Example 48. Creating a complex array datatype from a text description

Chapter 7

HDF5 Dataspaces and Partial I/O

7.1. Introduction

The HDF5 *dataspace* is a required component of an HDF5 dataset or attribute definition. The dataspace defines the size and shape of the dataset or attribute raw data. In other words, a dataspace defines the number of dimensions and the size of each dimension of the multidimensional array in which the raw data is represented. The dataspace must be defined when the dataset or attribute is created.

The *dataspace* is also used during dataset I/O operations, defining the elements of the dataset that participate in the I/O operation.

This chapter explains the *dataspace* object and its use in dataset and attribute creation and data transfer. It also describes selection operations on a dataspace used to implement sub-setting, sub-sampling, and scatter-gather access to datasets.

The rest of this chapter is structured as follows:

- Section 2, “Dataspace Function Summaries,” provides a categorized list of dataspace functions, also known as the H5S APIs
- Section 3, “Definition of Dataspace Objects and the Dataspace Programming Model,” describes dataspace objects and the programming model, including the creation and use of dataspaces
- Section 4, “Dataspaces and Data Transfer,” describes the use of dataspaces in data transfer
- Section 5, “Dataspace Selection Operations and Data Transfer,” describes selection operations on dataspaces and their usage in data transfer
- Section 6, “References to Dataset Regions,” briefly discusses references to dataset regions
- Section 7, “Sample Programs,” contains the full programs from which several of the code samples in this chapter were derived

7.2. Dataspace (H5S) Function Summaries

This section provides a reference list of dataspace functions, the H5S APIs, with brief descriptions. The functions are presented in the following categories:

- Dataspace management functions
- Dataspace query functions
- Dataspace selection functions: hyperslabs
- Dataspace selection functions: points

Sections 3 through 6 will provide examples and explanations of how to use these functions.

Function Listing 1. Dataspace management functions

C Function	Purpose
Fortran Function	
H5Screate	Creates a new dataspace of a specified type.
h5screate_f	
H5Scopy	Creates an exact copy of a dataspace.
h5scopy_f	
H5Sclose	Releases and terminates access to a dataspace.
h5sclose_f	
H5Sdecode	Decode a binary object description of a dataspace and return a new object identifier.
h5sdecode_f	
H5Sencode	Encode a dataspace object description into a binary buffer.
h5sencode	
H5Screate_simple	Creates a new simple dataspace and opens it for access.
h5screate_simple_f	
H5Sis_simple	Determines whether a dataspace is a simple dataspace.
h5sis_simple_f	
H5Sextent_copy	Copies the extent of a dataspace.
h5sextent_copy_f	
H5Sextent_equal	Determines whether two dataspace extents are equal.
h5sextent_equal_f	
H5Sset_extent_simple	Sets or resets the size of an existing dataspace.
h5sset_extent_simple_f	
H5Sset_extent_none	Removes the extent from a dataspace.
h5sset_extent_none_f	

Function Listing 2. Dataspace query functions

C Function	Purpose
Fortran Function	
H5Sget_simple_extent_dims	Retrieves dataspace dimension size and maximum size.
h5sget_simple_extent_dims_f	
H5Sget_simple_extent_ndims	Determines the dimensionality of a dataspace.
h5sget_simple_extent_ndims_f	
H5Sget_simple_extent_npoints	Determines the number of elements in a dataspace.
h5sget_simple_extent_npoints_f	
H5Sget_simple_extent_type	Determine the current class of a dataspace.
h5sget_simple_extent_type_f	

Function Listing 3. Dataspace selection functions: hyperslabs

C Function	Purpose
Fortran Function	
H5Soffset_simple	Sets the offset of a simple dataspace.
h5soffset_simple_f	
H5Sget_select_type	Determines the type of the dataspace selection.
h5sget_select_type_f	
H5Sget_select_hyper_nblocks	Get number of hyperslab blocks.
h5sget_select_hyper_nblocks_f	
H5Sget_select_hyper_blocklist	Gets the list of hyperslab blocks currently selected.
h5sget_select_hyper_blocklist_f	
H5Sget_select_bounds	Gets the bounding box containing the current selection.
h5sget_select_bounds_f	
H5Sselect_all	Selects the entire dataspace.
h5sselect_all_f	
H5Sselect_none	Resets the selection region to include no elements.
h5sselect_none_f	
H5Sselect_valid	Verifies that the selection is within the extent of the dataspace.
h5sselect_valid_f	
H5Sselect_hyperslab	Selects a hyperslab region to add to the current selected region.
h5sselect_hyperslab_f	

Function Listing 4. Dataspace selection functions: points

C Function	Purpose
Fortran Function	
H5Sget_select_npoints	Determines the number of elements in a dataspace selection.
h5sget_select_npoints_f	
H5Sget_select_elem_npoints	Gets the number of element points in the current selection.
h5sget_select_elem_npoints_f	
H5Sget_select_elem_pointlist	Gets the list of element points currently selected.
h5sget_select_elem_pointlist_f	
H5Sselect_elements	Selects array elements to be included in the selection for a dataspace.
h5sselect_elements_f	

7.3. Definition of Dataspace Objects and the Dataspace Programming Model

This section introduces the notion of the HDF5 dataspace object and a programming model for creating and working with dataspaces.

7.3.1. Dataspace Objects

An HDF5 dataspace is a required component of an HDF5 dataset or attribute. A dataspace defines the size and the shape of a dataset's or an attribute's raw data. Currently, HDF5 supports the following types of the dataspace:

- Scalar dataspace
- Simple dataspace
- Null dataspace

A *scalar dataspace*, `H5S_SCALAR`, represents just one element, a scalar. Note that the datatype of this one element may be very complex, e.g., a compound structure with members being of any allowed HDF5 datatype, including multidimensional arrays, strings, and nested compound structures. By convention, the rank of a scalar dataspace is always 0 (zero); think of it geometrically as a single, dimensionless point, though that point may be complex.

A *simple dataspace*, `H5S_SIMPLE`, is a multidimensional array of elements. The dimensionality of the dataspace (or the rank of the array) is fixed and is defined at creation time. The size of each dimension can grow during the life time of the dataspace from the *current size* up to the *maximum size*. Both the current size and the maximum size are specified at creation time. The sizes of dimensions at any particular time in the life of a dataspace are called the *current dimensions*, or the *dataspace extent*. They can be queried along with the maximum sizes.

A *null dataspace*, `H5S_NULL`, contains no data elements. Note that no selections can be applied to a null dataset as there is nothing to select.

As shown in the UML diagram in the figure below, an HDF5 simple dataspace object has three attributes: the rank or number of dimensions; the current sizes, expressed as an array of length rank with each element of the array denoting the current size of the corresponding dimension; and the maximum sizes, expressed as an array of length rank with each element of the array denoting the maximum size of the corresponding dimension.

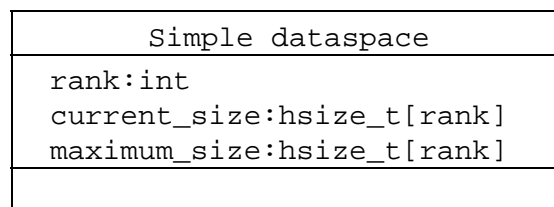

Figure 1. A simple dataspace

A simple dataspace is defined by its rank, the current size of each dimension, and the maximum size of each dimension.

The size of a current dimension cannot be greater than the maximum size, which can be unlimited, specified as `H5S_UNLIMITED`. Note that while the HDF5 file format and library impose no maximum size on an unlimited dimension, practically speaking its size will always be limited to the biggest integer available on the particular

system being used.

Dataspace rank is restricted to 32, the standard limit in C on the rank of an array, in the current implementation of the HDF5 Library. The HDF5 file format, on the other hand, allows any rank up to the maximum integer value on the system, so the library restriction can be raised in the future if higher dimensionality is required.

Note that most of the time Fortran applications calling HDF5 will work with dataspace ranks less than or equal to seven, since seven is the maximum number of dimensions in a Fortran array. But dataspace rank is not limited to seven for Fortran applications.

The current dimensions of a dataspace, also referred to as the dataspace extent, define the bounding box for dataset elements that can participate in I/O operations.

7.3.2. Programming Model

The programming model for creating and working with HDF5 dataspace can be summarized as follows:

1. Create a dataspace
2. Use the dataspace to create a dataset in the file or to describe a data array in memory
3. Modify the dataspace to define dataset elements that will participate in I/O operations
4. Use the modified dataspace while reading/writing dataset raw data or to create a region reference
5. Close the dataspace when no longer needed

The rest of this section will address steps 1, 2, and 5 of the programming model; steps 3 and 4 will be discussed in later sections of this chapter.

7.3.2.1. Creating a Dataspace

A dataspace can be created by calling the `H5Screate` function (`h5screate_f` in Fortran). Since the definition of a simple dataspace requires the specification of dimensionality (or rank) and initial and maximum dimension sizes, the HDF5 Library provides a *convenience* API, `H5Screate_simple` (`h5screate_simple_f`) to create a simple dataspace in one step.

The following examples illustrate the usage of these APIs.

7.3.2.2. Creating a Scalar Dataspace

A scalar dataspace is created with the `H5Screate` or the `h5screate_f` function.

In C:

```
hid_t space_id;
. . .
space_id = H5Screate(H5S_SCALAR);
```

In Fortran:

```
INTEGER(HID_T) :: space_id
. . .
CALL h5screate_f(H5S_SCALAR_F, space_id, error)
```

As mentioned above, the dataspace will contain only one element. Scalar dataspaces are used more often for describing attributes that have just one value, e.g. the attribute temperature with the value celsius is used to indicate that the dataset with this attribute stores temperature values using the celsius scale.

7.3.2.3. Creating a Null Dataspace

A null dataspace is created with the `H5Screate` or the `h5screate_f` function.

In C:

```
hid_t space_id;
. . .
space_id = H5Screate(H5S_NULL);
```

In Fortran:

(`H5S_NULL` not yet implemented in Fortran.)

```
INTEGER(HID_T) :: space_id
. . .
CALL h5screate_f(H5S_NULL_F, space_id, error)
```

As mentioned above, the dataspace will contain no elements.

7.3.2.4. Creating a Simple Dataspace

Let's assume that an application wants to store a two-dimensional array of data, `A(20,100)`. During the life of the application, the first dimension of the array can grow up to 30; there is no restriction on the size of the second dimension. The following steps are used to declare a dataspace for the dataset in which the array data will be stored.

In C:

```
hid_t space_id;
int rank = 2;
hsize_t current_dims[2] = {20, 100};
hsize_t max_dims[2] = {30, H5S_UNLIMITED};
. . .
space_id = H5Screate(H5S_SIMPLE);
H5Sset_extent_simple(space_id, rank, current_dims, max_dims);
```

In Fortran:

```
INTEGER(HID_T) :: space_id
INTEGER :: rank = 2
INTEGER(HSIZE_T) :: current_dims = /( 20, 100)/
INTEGER(HSIZE_T) :: max_dims = /(30, H5S_UNLIMITED_F)/
INTEGER error
. . .
CALL h5screate_f(H5S_SIMPLE_F, space_id, error)
```

```
CALL h5sset_extent_simple_f(space_id, rank, current_dims, max_dims, error)
```

Alternatively, the convenience APIs `H5Screate_simple/h5screate_simple_f` can replace the `H5Screate/h5screate_f` and `H5Sset_extent_simple/h5sset_extent_simple_f` calls.

In C:

```
space_id = H5Screate_simple(rank, current_dims, max_dims);
```

In Fortran:

```
CALL h5screate_simple_f(rank, current_dims, space_id, error, max_dims)
```

In this example, a dataspace with current dimensions of 20 by 100 is created. The first dimension can be extended only up to 30. The second dimension, however, is declared unlimited; it can be extended up to the largest available integer value on the system.

Note that when there is a difference between the current dimensions and the maximum dimensions of an array, then chunking storage must be used. In other words, if the number of dimensions may change over the life of the dataset, then chunking must be used. If the array dimensions are fixed (if the number of current dimensions is equal to the maximum number of dimensions when the dataset is created), then contiguous storage can be used. See the “Data Transfer” section in the “Datasets” chapter.

Maximum dimensions can be the same as current dimensions. In such a case, the sizes of dimensions cannot be changed during the life of the dataspace object. In C, `NULL` can be used to indicate to the `H5Screate_simple` and `H5Sset_extent_simple` functions that the maximum sizes of all dimensions are the same as the current sizes. In Fortran, the maximum size parameter is optional for `h5screate_simple_f` and can be omitted when the sizes are the same.

In C:

```
space_id = H5Screate_simple(rank, current_dims, NULL);
```

In Fortran:

```
CALL h5screate_f(rank, current_dims, space_id, error)
```

The created dataspace will have current and maximum dimensions of 20 and 100 correspondingly, and the sizes of those dimensions cannot be changed.

7.3.2.5. C versus Fortran Dataspaces

Dataspace dimensions are numbered from 1 to rank. HDF5 uses C storage conventions, assuming that the last listed dimension is the fastest-changing dimension and the first-listed dimension is the slowest changing. The HDF5 file format storage layout specification adheres to the C convention and the HDF5 Library adheres to the same convention when storing dataspace dimensions in the file. This affects how C programs and tools interpret data written from Fortran programs and vice versa. The example below illustrates the issue.

When a Fortran application describes a dataspace to store an array as A(20,100), it specifies the value of the first dimension to be 20 and the second to be 100. Since Fortran stores data by columns, the first-listed dimension with the value 20 is the fastest-changing dimension and the last-listed dimension with the value 100 is the slowest-changing. In order to adhere to the HDF5 storage convention, the HDF5 Fortran wrapper transposes dimensions, so the first dimension becomes the last. The dataspace dimensions stored in the file will be 100,20 instead of 20,100 in order to correctly describe the Fortran data that is stored in 100 columns, each containing 20 elements.

When a Fortran application reads the data back, the HDF5 Fortran wrapper transposes the dimensions once more, returning the first dimension to be 20 and the second to be 100, describing correctly the sizes of the array that should be used to read data in the Fortran array A(20,100).

When a C application reads data back, the dimensions will come out as 100 and 20, correctly describing the size of the array to read data into, since the data was written as 100 records of 20 elements each. Therefore C tools such as h5dump and h5ls always display transposed dimensions and values for the data written by a Fortran application.

Consider the following simple example of equivalent C 3 x 5 and Fortran 5 x 3 arrays. As illustrated in the figure below, a C applications will store a 3 x 5 2-dimensional array as three 5-element rows. In order to store the same data in the same order, a Fortran application must view the array as a 5 x 3 array with three 5-element columns. The dataspace of this dataset, as written from Fortran, will therefore be described as 5 x 3 in the application but stored and described in the file according to the C convention as a 3 x 5 array. This ensures that C and Fortran applications will always read the data in the order in which it was written. The HDF5 Fortran interface handles this transposition automatically.

In C (from h5_write.c):

```

#define NX      3                /* dataset dimensions */
#define NY      5
. . .
int            data[NX][NY];    /* data to write */
. . .
/*
 * Data and output buffer initialization.
 */
for (j = 0; j < NX; j++) {
    for (i = 0; i < NY; i++)
        data[j][i] = i + 1 + j*NY;
}
/*
 * 1  2  3  4  5
 * 6  7  8  9 10
 * 11 12 13 14 15
 */
. . .
dims[0] = NX;
dims[1] = NY;
dataspace = H5Screate_simple(RANK, dims, NULL);

```

In Fortran (from `h5_write.f90`):

```

INTEGER, PARAMETER :: NX = 3
INTEGER, PARAMETER :: NY = 5
. . .
INTEGER(HSIZE_T), DIMENSION(2) :: dims = (/3,5/) ! Dataset dimensions
---
INTEGER      ::      data(NX,NY)
. . .
!
! Initialize data
!
  do i = 1, NX
    do j = 1, NY
      data(i,j) = j + (i-1)*NY
    enddo
  enddo
!
! Data
!
!  1  2  3  4  5
!  6  7  8  9 10
! 11 12 13 14 15
. . .
CALL h5screate_simple_f(rank, dims, dspace_id, error)

```

In Fortran (from `h5_write_tr.f90`):

```

INTEGER, PARAMETER :: NX = 3
INTEGER, PARAMETER :: NY = 5
. . .
INTEGER(HSIZE_T), DIMENSION(2) :: dims = (/NY, NX/) ! Dataset dimensions
. . .
!
! Initialize data
!
  do i = 1, NY
    do j = 1, NX
      data(i,j) = i + (j-1)*NY
    enddo
  enddo
!
! Data
!
!  1  6  11
!  2  7  12
!  3  8  13
!  4  9  14
!  5 10  15
. . .
CALL h5screate_simple_f(rank, dims, dspace_id, error)

```

A dataset stored by a
C program in a 3 x 5 array:

1	2	3	4	5
6	7	8	9	10
11	12	13	14	15

The same dataset stored by a
Fortran program in a 5 x 3 array:

1	6	11
2	7	12
3	8	13
4	9	14
5	10	15

The left-hand dataset above as written to an HDF5 file from C or the right-hand dataset as written from Fortran:

1	2	3	4	5	6	7	8	9	10	11	12	13	14	15
---	---	---	---	---	---	---	---	---	----	----	----	----	----	----

The left-hand dataset above as written to an HDF5 file from Fortran:

1	6	11	2	7	12	3	8	13	4	9	14	5	10	15
---	---	----	---	---	----	---	---	----	---	---	----	---	----	----

Figure 2. Comparing C and Fortran dataspace

The HDF5 Library stores arrays along the fastest-changing dimension. This approach is often referred to as being “in C order.” C, C++, and Java work with arrays in row-major order. In other words, the row, or the last dimension, is the fastest-changing dimension. Fortran, on the other hand, handles arrays in column-major order making the column, or the first dimension, the fastest-changing dimension. Therefore, the C and Fortran arrays illustrated in the top portion of this figure are stored identically in an HDF5 file. This ensures that data written by any language can be meaningfully read, interpreted, and manipulated by any other.

7.3.2.6. Finding Dataspace Characteristics

The HDF5 Library provides several APIs designed to query the characteristics of a dataspace.

The function `H5Sis_simple` (`h5sis_simple_f`) returns information about the type of a dataspace. This function is rarely used and currently supports only simple and scalar dataspace.

To find out the dimensionality, or rank, of a dataspace, use `H5Sget_simple_extent_ndims` (`h5sget_simple_extent_ndims_f`). `H5Sget_simple_extent_dims` can also be used to find out the rank. See the example below. If both functions return 0 for the value of rank, then the dataspace is scalar.

To query the sizes of the current and maximum dimensions, use `H5Sget_simple_extent_dims` (`h5sget_simple_extent_dims_f`).

The following example illustrates querying the rank and dimensions of a dataspace using these functions.

In C:

```
hid_t space_id;
int rank;
hsize_t *current_dims;
hsize_t *max_dims;
-----

rank=H5Sget_simple_extent_ndims(space_id);
    (or rank=H5Sget_simple_extent_dims(space_id, NULL, NULL);)
current_dims= (hsize_t)malloc(rank*sizeof(hsize_t));
max_dims=(hsize_t)malloc(rank*sizeof(hsize_t));
H5Sget_simple_extent_dims(space_id, current_dims, max_dims);
Print values here for the previous example
```

7.4. Dataspaces and Data Transfer

The *dataspace* object is also used to control data transfer when data is read or written. The *dataspace* of the dataset (attribute) defines the stored form of the array data, the order of the elements as explained above. When reading from the file, the *dataspace* of the dataset defines the layout of the source data, a similar description is needed for the destination storage. A *dataspace* object is used to define the organization of the data (rows, columns, etc.) in memory. If the program requests a different order for memory than the storage order, the data will be rearranged by the HDF5 Library during the `H5Dread` operation. Similarly, when writing data, the memory *dataspace* defines the source data, which is converted to the dataset *dataspace* when stored by the `H5Dwrite` call.

Item a in the figure below shows a simple example of a read operation in which the data is stored as a 3 by 4 array in the file (item b), but the program wants it to be a 4 by 3 array in memory. This is accomplished by setting the memory *dataspace* to describe the desired memory layout, as in item c. The HDF5 Library will transform the data to the correct arrangement during the read operation.

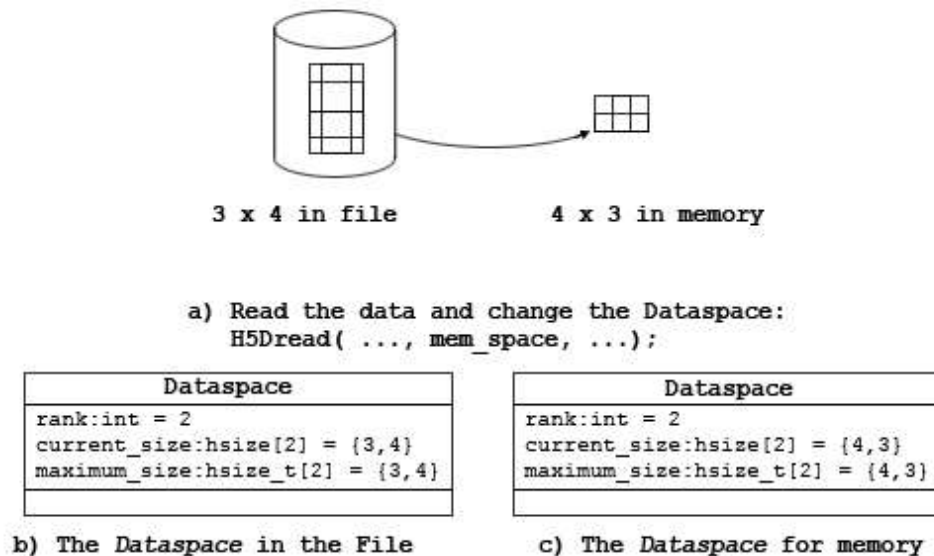

Figure 3. Data layout before and after a read operation

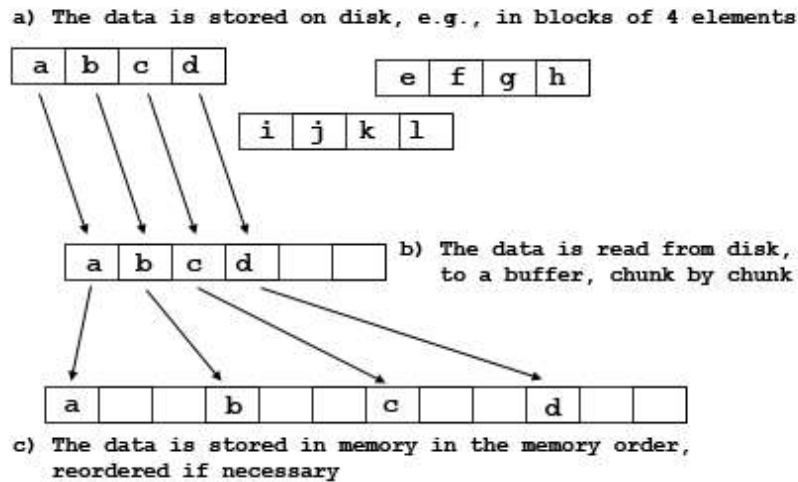

Figure 4. Moving data from disk to memory

Both the source and destination are stored as contiguous blocks of storage with the elements in the order specified by the *dataspace*. The figure above shows one way the elements might be organized. In item a, the elements are stored as 3 blocks of 4 elements. The destination is an array of 12 elements in memory (see item c). As the figure suggests, the transfer reads the disk blocks into a memory buffer (see item b), and then writes the elements to the correct locations in memory. A similar process occurs in reverse when data is written to disk.

7.4.1. Data Selection

In addition to rearranging data, the transfer may select the data elements from the source and destination.

Data selection is implemented by creating a *dataspace* object that describes the selected elements (within the hyper rectangle) rather than the whole array. Two *dataspace* objects with selections can be used in data transfers to read selected elements from the source and write selected elements to the destination. When data is transferred using the *dataspace* object, only the selected elements will be transferred.

This can be used to implement partial I/O, including:

- Sub-setting - reading part of a large dataset
- Sampling - reading selected elements (e.g., every second element) of a dataset
- Scatter-gather - read non-contiguous elements into contiguous locations (gather) or read contiguous elements into non-contiguous locations (scatter) or both

To use selections, the following steps are followed:

1. Get or define the *dataspace* for the source and destination
2. Specify one or more selections for source and destination *dataspaces*
3. Transfer data using the *dataspaces* with selections

A selection is created by applying one or more selections to a *dataspace*. A selection may override any other selections (H5T_SELECT_SET) or may be “Ored” with previous selections on the same dataspace (H5T_SELECT_OR). In the latter case, the resulting selection is the union of the selection and all previously selected selections. Arbitrary sets of points from a dataspace can be selected by specifying an appropriate set of selections.

Two selections are used in data transfer, so the source and destination must be compatible, as described below.

There are two forms of selection, hyperslab and point. A selection must be either a point selection or a set of hyperslab selections. Selections cannot be mixed.

The definition of a selection within a dataspace, not the data in the selection, cannot be saved to the file unless the selection definition is saved as a region reference. See the [References to Dataset Regions](#) section for more information.

7.4.1.1. Hyperslab selection

A hyperslab is a selection of elements from a hyper rectangle. An HDF5 hyperslab is a rectangular pattern defined by four arrays. The four arrays are summarized in the table below .

The *offset* defines the origin of the hyperslab in the original dataspace.

The *stride* is the number of elements to increment between selected elements. A stride of ‘1’ is every element, a stride of ‘2’ is every second element, etc. Note that there may be a different stride for each dimension of the dataspace. The default stride is 1.

The *count* is the number of elements in the hyperslab selection. When the stride is 1, the selection is a hyper rectangle with a corner at the offset and size count[0] by count[1] by.... When stride is greater than one, the hyperslab bounded by the offset and the corners defined by stride[n] * count[n].

Table 1. Hyperslab elements

Parameter	Description
Offset	The starting location for the hyperslab.
Stride	The number of elements to separate each element or block to be selected.
Count	The number of elements or blocks to select along each dimension.
Block	The size of the block selected from the dataspace.

The *block* is a count on the number of repetitions of the hyperslab. The default block size is ‘1’, which is one hyperslab. A block of 2 would be two hyperslabs in that dimension, with the second starting at offset[n]+ (count[n] * stride[n]) + 1.

A hyperslab can be used to access a sub-set of a large dataset. The figure below shows an example of a hyperslab that reads a rectangle from the middle of a larger two dimensional array. The destination is the same shape as the source.

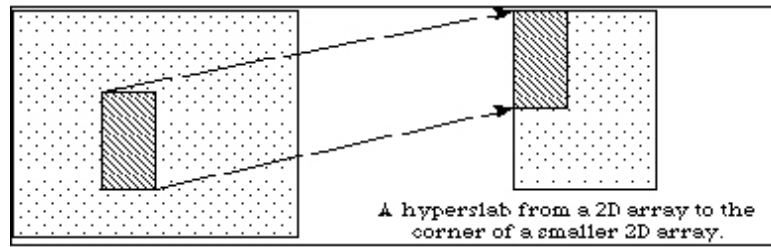

Figure 5. Access a sub-set of data with a hyperslab

Hyperslabs can be combined to select complex regions of the source and destination. The figure below shows an example of a transfer from one non-rectangular region into another non-rectangular region. The source is defined as the union of two hyperslabs, and the destination is the union of three hyperslabs.

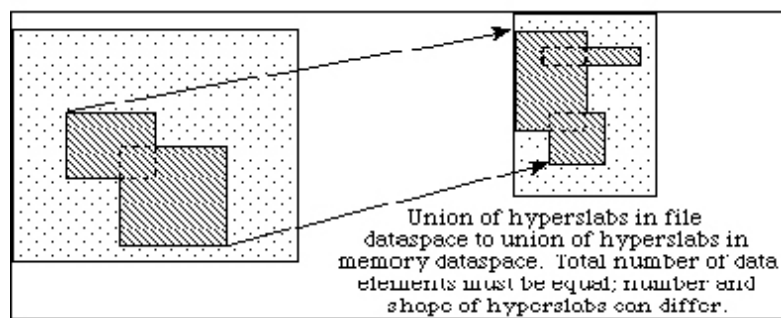

Figure 6. Build complex regions with hyperslab unions

Hyperslabs may also be used to collect or scatter data from regular patterns. The figure below shows an example where the source is a repeating pattern of blocks, and the destination is a single, one dimensional array.

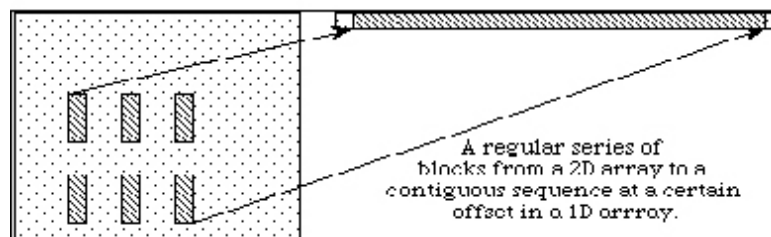

Figure 7. Use hyperslabs to combine or disperse data

7.4.1.2. Select Points

The second type of selection is an array of points, i.e., coordinates. Essentially, this selection is a list of all the points to include. The figure below shows an example of a transfer of seven elements from a two dimensional dataspace to a three dimensional dataspace using a point selection to specify the points.

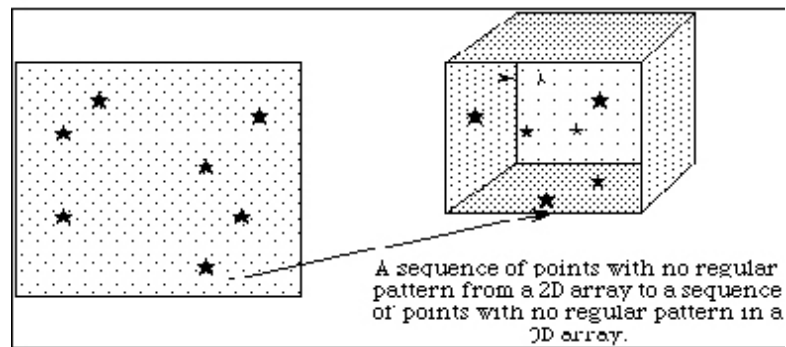

Figure 8. Point selection

7.4.1.3. Rules for Defining Selections

A selection must have the same number of dimensions (rank) as the dataspace it is applied to, although it may select from only a small region, e.g., a plane from a 3D dataspace. Selections do not affect the extent of the *dataspace*, the selection may be larger than the *dataspace*. The boundaries of selections are reconciled with the extent at the time of the data transfer.

7.4.1.4. Data Transfer with Selections

A data transfer (read or write) with selections is the same as any read or write, except the source and destination *dataspace* have compatible selections.

During the data transfer, the following steps are executed by the library:

- The source and destination *dataspaces* are checked to assure that the selections are compatible.
 - ◆ Each selection must be within the current extent of the *dataspace*. A selection may be defined to extend outside the current extent of the *dataspace*, but the *dataspace* cannot be accessed if the selection is not valid at the time of the access.
 - ◆ The total number of points selected in the source and destination must be the same. Note that the dimensionality of the source and destination can be different (e.g., the source could be 2D, the destination 1D or 3D), and the shape can be different, but the number of elements selected must be the same.
- The data is transferred, element by element.

Selections have an iteration order for the points selected, which can be any permutation of the dimensions involved (defaulting to ‘C’ array order) or a specific order for the selected points, for selections composed of single array elements with `H5Sselect_elements`.

The elements of the selections are transferred in row-major, or C order. That is, it is assumed that the first dimension varies slowest, the second next slowest, and so forth. For hyperslab selections, the order can be any permutation of the dimensions involved (defaulting to ‘C’ array order). When multiple hyperslabs are combined, the hyperslabs are coalesced into contiguous reads and writes.

In the case of point selections, the points are read and written in the order specified.

7.4.2. Programming Model

7.4.2.1. Selecting Hyperslabs

Suppose we want to read a 3x4 hyperslab from a dataset in a file beginning at the element <1,2> in the dataset, and read it into a 7 x 7 x 3 array in memory. See the figure below. In order to do this, we must create a dataspace that describes the overall rank and dimensions of the dataset in the file as well as the position and size of the hyperslab that we are extracting from that dataset.

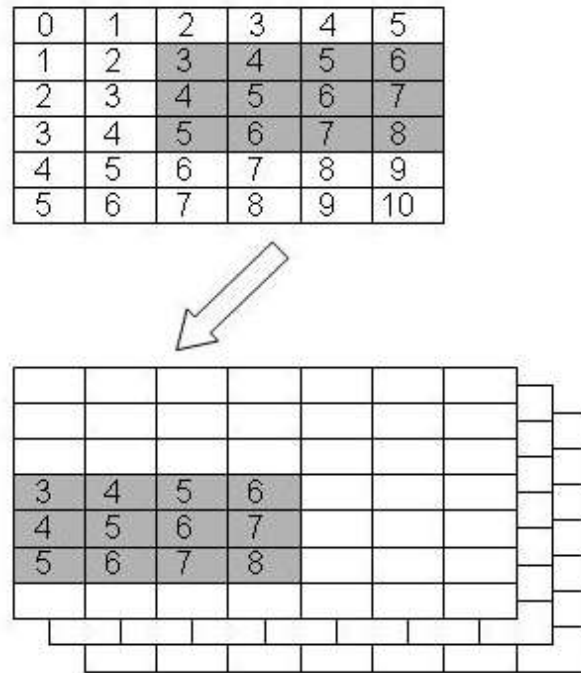

Figure 9. Selecting a hyperslab

The code in the first example below illustrates the selection of the hyperslab in the file dataspace. The second example below shows the definition of the destination dataspace in memory. Since the in-memory dataspace has three dimensions, the hyperslab is an array with three dimensions with the last dimension being 1: <3,4,1>. The third example below shows the read using the source and destination *dataspaces* with selections.

```

/*
 * get the file dataspace.
 */
dataspace = H5Dget_space(dataset);    /* dataspace identifier */

/*
 * Define hyperslab in the dataset.
 */
offset[0] = 1;
offset[1] = 2;
count[0] = 3;
count[1] = 4;
status = H5Sselect_hyperslab(dataspace, H5S_SELECT_SET, offset, NULL,
                             count, NULL);

```

Example 1. Selecting a hyperslab

```

/*
 * Define memory dataspace.
 */
dimsm[0] = 7;
dimsm[1] = 7;
dimsm[2] = 3;
memspace = H5Screate_simple(3,dimsm,NULL);

/*
 * Define memory hyperslab.
 */
offset_out[0] = 3;
offset_out[1] = 0;
offset_out[2] = 0;
count_out[0] = 3;
count_out[1] = 4;
count_out[2] = 1;
status = H5Sselect_hyperslab(memspace, H5S_SELECT_SET, offset_out, NULL,
                             count_out, NULL);

```

Example 2. Defining the destination memory

```

ret = H5Dread(dataset, H5T_NATIVE_INT, memspace, dataspace, H5P_DEFAULT,
              data);

```

Example 3. A sample read specifying source and destination dataspace

7.4.2.2. Example with Strides and Blocks

Consider an 8 x 12 dataspace into which we want to write eight 3 x 2 blocks in a two dimensional array from a source dataspace in memory that is a 50-element one dimensional array. See the figure below.

a) The source is a 1D array with 50 elements

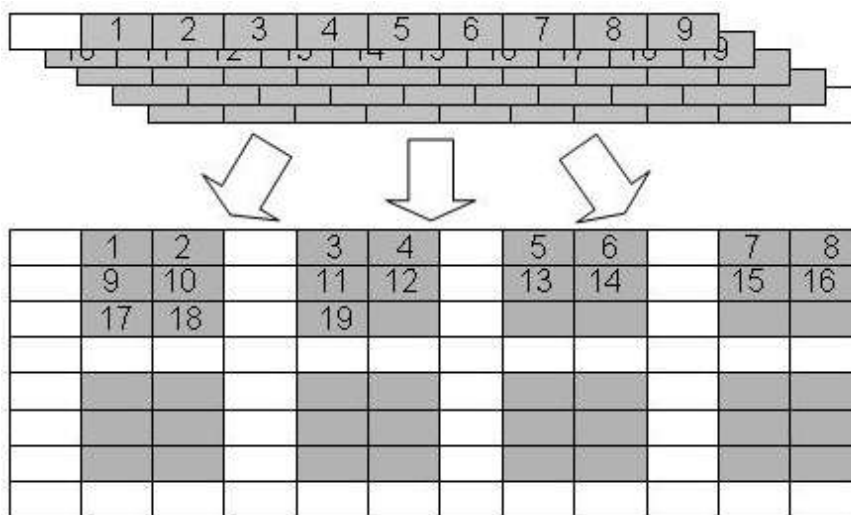

b) The destination on disk is a 2D array with 48 selected elements

Figure 10. Write from a one dimensional array to a two dimensional array

The example below shows code to write 48 elements from the one dimensional array to the file dataset starting with the second element in vector. The destination hyperslab has the following parameters: offset=(0,1), stride=(4,3), count=(2,4), block=(3,2). The source has the parameters: offset=(1), stride=(1), count=(48), block=(1). After these operations, the file dataspace will have the values shown in item b in the figure above . Notice that the values are inserted in the file dataset in row-major order.

```

/* Select hyperslab for the dataset in the file, using 3 x 2 blocks, (4,3) stride
 * (2,4) count starting at the position (0,1).
 */
offset[0] = 0; offset[1] = 1;
stride[0] = 4; stride[1] = 3;
count[0] = 2; count[1] = 4;
block[0] = 3; block[1] = 2;
ret = H5Sselect_hyperslab(fid, H5S_SELECT_SET, offset, stride, count, block);

/*
 * Create dataspace for the first dataset.
 */
mid1 = H5Screate_simple(MSPACE1_RANK, dim1, NULL);

/*
 * Select hyperslab.
 * We will use 48 elements of the vector buffer starting at the second element.
 * Selected elements are 1 2 3 . . . 48
 */
offset[0] = 1;
stride[0] = 1;
count[0] = 48;
block[0] = 1;
ret = H5Sselect_hyperslab(mid1, H5S_SELECT_SET, offset, stride, count, block);

/*
 * Write selection from the vector buffer to the dataset in the file.
 */
ret = H5Dwrite(dataset, H5T_NATIVE_INT, mid1, fid, H5P_DEFAULT, vector)

```

Example 4. Write from a one dimensional array to a two dimensional array

7.4.2.3. Selecting a Union of Hyperslabs

The HDF5 Library allows the user to select a union of hyperslabs and write or read the selection into another selection. The shapes of the two selections may differ, but the number of elements must be equal.

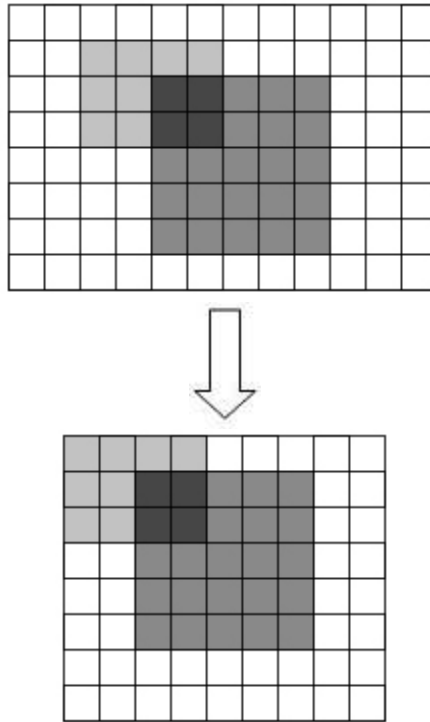

Figure 11. Transferring hyperslab unions

The figure above shows the transfer of a selection that is two overlapping hyperslabs from the dataset into a union of hyperslabs in the memory dataset. Note that the destination dataset has a different shape from the source dataset. Similarly, the selection in the memory dataset could have a different shape than the selected union of hyperslabs in the original file. For simplicity, the selection is that same shape at the destination.

To implement this transfer, it is necessary to:

1. Get the source dataspace
2. Define one hyperslab selection for the source
3. Define a second hyperslab selection, unioned with the first
4. Get the destination dataspace
5. Define one hyperslab selection for the destination
6. Define a second hyperslab selection, unioned with the first
7. Execute the data transfer (`H5Dread` or `H5Dwrite`) using the source and destination dataspace

The example below shows example code to create the selections for the source dataspace (the file). The first hyperslab is size 3 x 4 and the left upper corner at the position (1,2). The hyperslab is a simple rectangle, so the stride and block are 1. The second hyperslab is 6 x 5 at the position (2,4). The second selection is a union with the first hyperslab (H5S_SELECT_OR).

```

    fid = H5Dget_space(dataset);

/*
 * Select first hyperslab for the dataset in the file.
 *
 */
offset[0] = 1; offset[1] = 2;
block[0] = 1; block[1] = 1;
stride[0] = 1; stride[1] = 1;
count[0] = 3; count[1] = 4;
ret = H5Sselect_hyperslab(fid, H5S_SELECT_SET, offset, stride, count, block);
/*
 * Add second selected hyperslab to the selection.
 */
offset[0] = 2; offset[1] = 4;
block[0] = 1; block[1] = 1;
stride[0] = 1; stride[1] = 1;
count[0] = 6; count[1] = 5;
ret = H5Sselect_hyperslab(fid, H5S_SELECT_OR, offset, stride, count, block);

```

Example 5. Select source hyperslabs

The example below shows example code to create the selection for the destination in memory. The steps are similar. In this example, the hyperslabs are the same shape, but located in different positions in the dataspace. The first hyperslab is 3 x 4 and starts at (0,0), and the second is 6 x 5 and starts at (1,2).

Finally, the `H5Dread` call transfers the selected data from the file dataspace to the selection in memory.

In this example, the source and destination selections are two overlapping rectangles. In general, any number of rectangles can be OR'ed, and they do not have to be contiguous. The order of the selections does not matter, but the first should use `H5S_SELECT_SET`; subsequent selections are unioned using `H5S_SELECT_OR`.

It is important to emphasize that the source and destination do not have to be the same shape (or number of rectangles). As long as the two selections have the same number of elements, the data can be transferred.

```

/*
 * Create memory dataspace.
 */
mid = H5Screate_simple(MSPACE_RANK, mdim, NULL);

/*
 * Select two hyperslabs in memory. Hyperslabs has the same
 * size and shape as the selected hyperslabs for the file dataspace.
 */
offset[0] = 0; offset[1] = 0;
block[0] = 1; block[1] = 1;
stride[0] = 1; stride[1] = 1;
count[0] = 3; count[1] = 4;
ret = H5Sselect_hyperslab(mid, H5S_SELECT_SET, offset, stride, count, block);
offset[0] = 1; offset[1] = 2;
block[0] = 1; block[1] = 1;
stride[0] = 1; stride[1] = 1;
count[0] = 6; count[1] = 5;
ret = H5Sselect_hyperslab(mid, H5S_SELECT_OR, offset, stride, count, block);

ret = H5Dread(dataset, H5T_NATIVE_INT, mid, fid, H5P_DEFAULT, matrix_out);

```

Example 6. Select destination hyperslabs

7.4.2.4. Selecting a List of Independent Points

It is also possible to specify a list of elements to read or write using the function `H5Sselect_elements`. The procedure is similar to hyperslab selections.

1. Get the source dataspace
2. Set the selected points
3. Get the destination dataspace
4. Set the selected points
5. Transfer the data using the source and destination dataspace

The figure below shows an example where four values are to be written to four separate points in a two dimensional dataspace. The source dataspace is a one dimensional array with the values 53, 59, 61, 67. The destination dataspace is an 8 x 12 array. The elements are to be written to the points (0,0), (3,3), (3,5), and (5,6). In this example, the source does not require a selection. The example below the figure shows example code to implement this transfer.

A point selection lists the exact points to be transferred and the order they will be transferred. The source and destination are required to have the same number of elements. A point selection can be used with a hyperslab (e.g., the source could be a point selection and the destination a hyperslab, or vice versa), so long as the number of elements selected are the same.

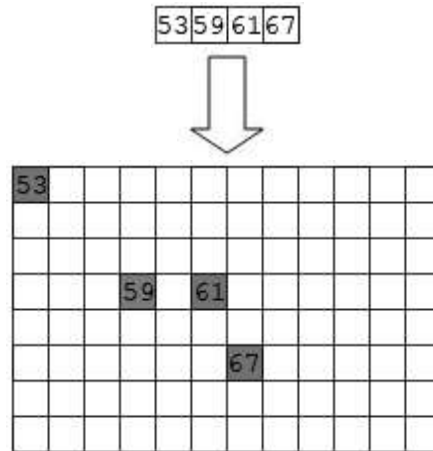

Figure 12. Write data to separate points

```

hsize_t dim2[] = {4};
int     values[] = {53, 59, 61, 67};

hssize_t coord[4][2]; /* Array to store selected points
                       from the file dataspace */

/*
 * Create dataspace for the second dataset.
 */
mid2 = H5Screate_simple(1, dim2, NULL);

/*
 * Select sequence of NPOINTS points in the file dataspace.
 */
coord[0][0] = 0; coord[0][1] = 0;
coord[1][0] = 3; coord[1][1] = 3;
coord[2][0] = 3; coord[2][1] = 5;
coord[3][0] = 5; coord[3][1] = 6;

ret = H5Sselect_elements(fid, H5S_SELECT_SET, NPOINTS,
                        (const hssize_t **)coord);

ret = H5Dwrite(dataset, H5T_NATIVE_INT, mid2, fid, H5P_DEFAULT, values);

```

Example 7. Write data to separate points

7.4.2.5. Combinations of Selections

Selections are a very flexible mechanism for reorganizing data during a data transfer. With different combinations of *dataspaces* and selections, it is possible to implement many kinds of data transfers including sub-setting, sampling, and reorganizing the data. The table below gives some example combinations of source and destination, and the operations they implement.

Table 2. Selection operations

Source	Destination	Operation
All	All	Copy whole array
All	All (different shape)	Copy and reorganize array
Hyperslab	All	Sub-set
Hyperslab	Hyperslab (same shape)	Selection
Hyperslab	Hyperslab (different shape)	Select and rearrange
Hyperslab with stride or block	All or hyperslab with stride 1	Sub-sample, scatter
Hyperslab	Points	Scatter
Points	Hyperslab or all	Gather
Points	Points (same)	Selection
Points	Points (different)	Reorder points

7.5. Dataspace Selection Operations and Data Transfer

This section is under construction.

7.6. References to Dataset Regions

Another use of selections is to store a reference to a region of a dataset. An HDF5 object reference object is a pointer to an object (dataset, group, or committed datatype) in the file. A selection can be used to create a pointer to a set of selected elements of a *dataset*, called a region reference. The selection can be either a point selection or a hyperslab selection.

A more complete description of region references can be found in the chapter “HDF5 Datatypes.”

A region reference is an object maintained by the HDF5 Library. The region reference can be stored in a dataset or attribute, and then read. The dataset or attribute is defined to have the special datatype, `H5T_STD_REF_DSETREG`.

To discover the elements and/or read the data, the region reference can be dereferenced. The `H5Rdereference` call returns an identifier for the *dataset*, and then the selected dataspace can be retrieved with `H5Rget_select` call. The selected *dataspace* can be used to read the selected data elements.

7.6.1. Example Uses for Region References

Region references are used to implement stored pointers to data within a dataset. For example, features in a large dataset might be indexed by a table. See the figure below. This table could be stored as an HDF5 dataset with a compound datatype, for example, with a field for the name of the feature and a region reference to point to the feature in the dataset. See the second figure below.

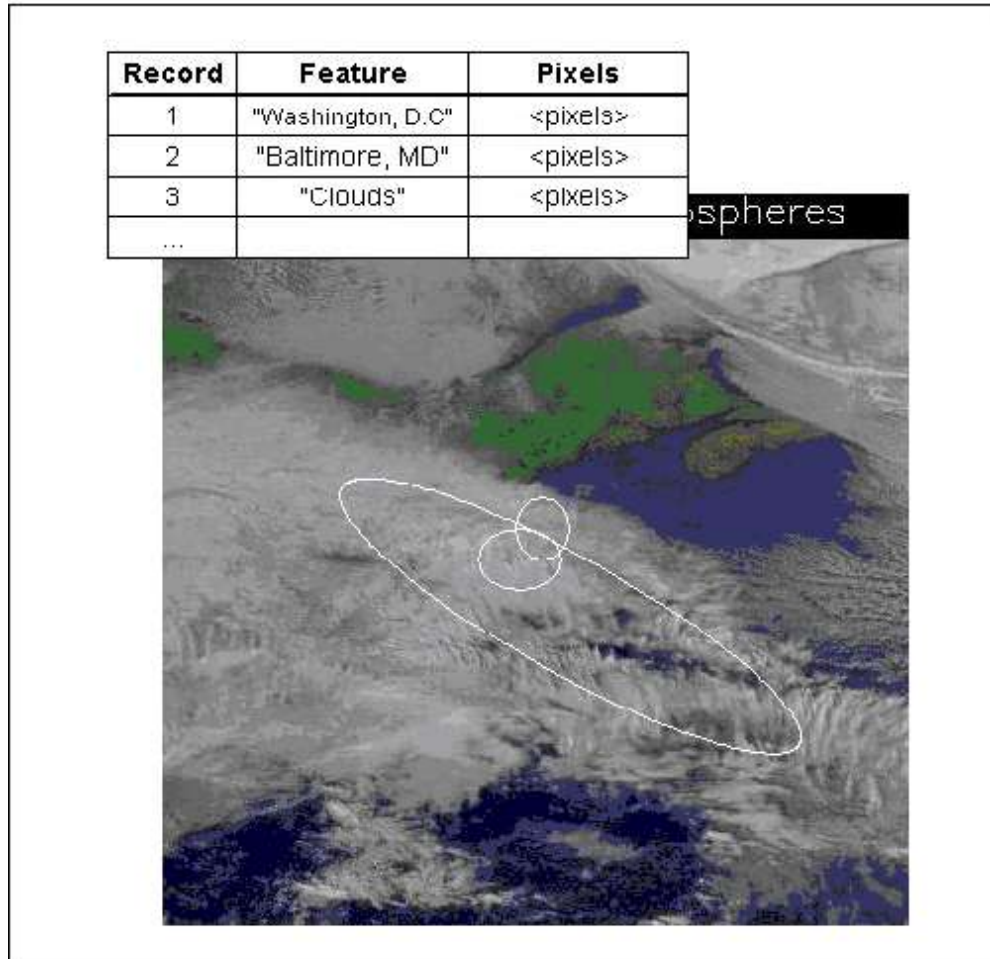
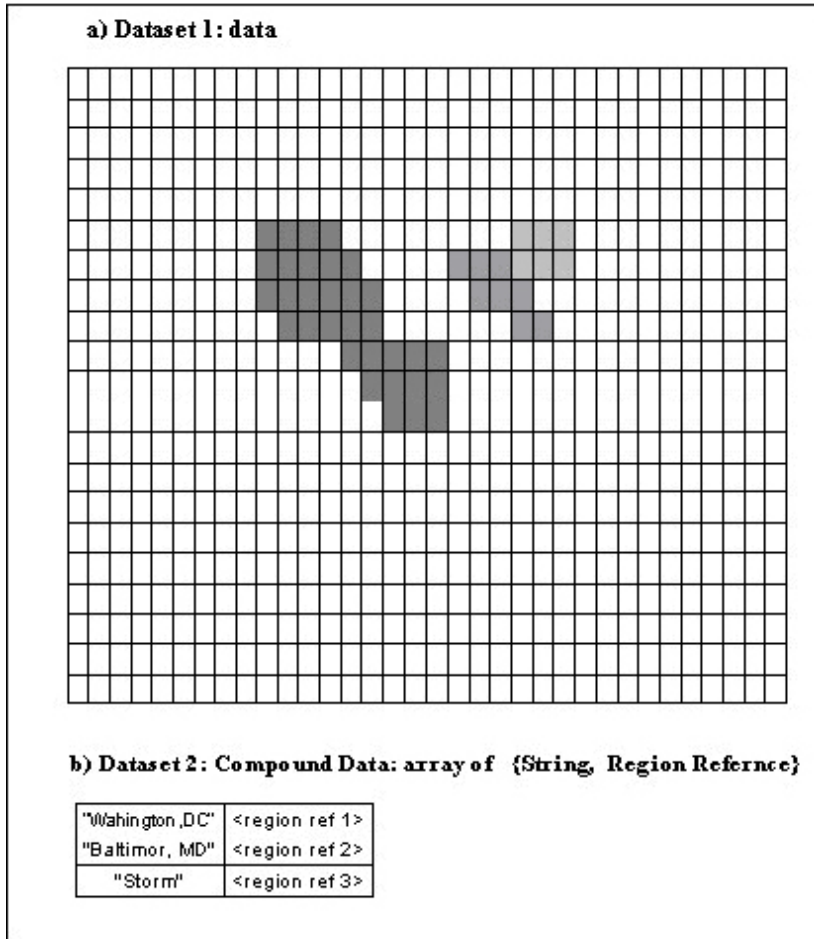

Figure 13. Features indexed by a table

a) Dataset 1: data



b) Dataset 2: Compound Data: array of {String, Region Reference}

"Washington, DC"	<region ref 1>
"Baltimore, MD"	<region ref 2>
"Storm"	<region ref 3>

Figure 14. Storing the table with a compound datatype

7.6.2. Creating References to Regions

To create a region reference:

1. Create or open the dataset that contains the region
2. Get the dataspace for the dataset
3. Define a selection that specifies the region
4. Create a region reference using the dataset and dataspace with selection
5. Write the region reference(s) to the desired dataset or attribute

The figure below shows a diagram of a file with three datasets. Dataset D1 and D2 are two dimensional arrays of integers. Dataset R1 is a one dimensional array of references to regions in D1 and D2. The regions can be any valid selection of the dataspace of the target dataset.

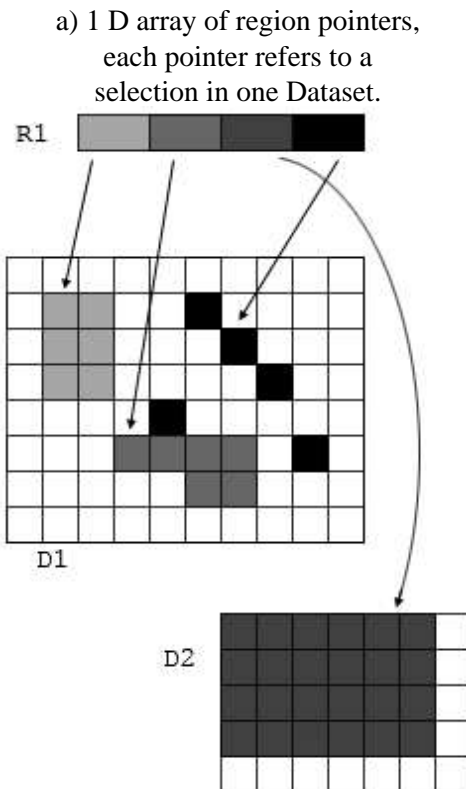

Figure 15. A file with three datasets

The example below shows code to create the array of region references. The references are created in an array of type `hdset_reg_ref_t`. Each region is defined as a selection on the dataspace of the dataset, and a reference is created using `H5Rcreate()`. The call to `H5Rcreate()` specifies the file, dataset, and the dataspace with selection.

```

/* create an array of 4 region references */
hdset_reg_ref_t ref[4];
/*
 * Create a reference to the first hyperslab in the first Dataset.
 */
offset[0] = 1; offset[1] = 1;
count[0] = 3; count[1] = 2;
status = H5Sselect_hyperslab(space_id, H5S_SELECT_SET, offset, NULL,
    count, NULL);
status = H5Rcreate(&ref[0], file_id, "D1", H5R_DATASET_REGION,
    space_id);

/*
 * The second reference is to a union of hyperslabs in the first
 * Dataset
 */

offset[0] = 5; offset[1] = 3;
count[0] = 1; count[1] = 4;
status = H5Sselect_none(space_id);
status = H5Sselect_hyperslab(space_id, H5S_SELECT_SET, offset,
    NULL, count, NULL);
offset[0] = 6; offset[1] = 5;
count[0] = 1; count[1] = 2;
status = H5Sselect_hyperslab(space_id, H5S_SELECT_OR, offset, NULL,
    count, NULL);
status = H5Rcreate(&ref[1], file_id, "D1", H5R_DATASET_REGION,
    space_id);

/*
 * the fourth reference is to a selection of points in the first
 * Dataset
 */
status = H5Sselect_none(space_id);
coord[0][0] = 4; coord[0][1] = 4;
coord[1][0] = 2; coord[1][1] = 6;
coord[2][0] = 3; coord[2][1] = 7;
coord[3][0] = 1; coord[3][1] = 5;
coord[4][0] = 5; coord[4][1] = 8;
status = H5Sselect_elements(space_id, H5S_SELECT_SET, num_points,
    (const hssize_t **)coord);
status = H5Rcreate(&ref[3], file_id, "D1", H5R_DATASET_REGION,
    space_id);

/*
 * the third reference is to a hyperslab in the second Dataset
 */
offset[0] = 0; offset[1] = 0;
count[0] = 4; count[1] = 6;
status = H5Sselect_hyperslab(space_id2, H5S_SELECT_SET, offset, NULL,
    count, NULL);
status = H5Rcreate(&ref[2], file_id, "D2", H5R_DATASET_REGION,
    space_id2);

```

Example 8. Create an array of region references

When all the references are created, the array of references is written to the dataset R1. The dataset is declared to have datatype H5T_STD_REF_DSETREG. See the example below.

```
Hsize_t dimsr[1];
dimsr[0] = 4;
/*
 * Dataset with references.
 */
spacer_id = H5Screate_simple(1, dimsr, NULL);
dsetr_id = H5Dcreate(file_id, "R1", H5T_STD_REF_DSETREG,
                    spacer_id, H5P_DEFAULT, H5P_DEFAULT, H5P_DEFAULT);

/*
 * Write dataset with the references.
 */
status = H5Dwrite(dsetr_id, H5T_STD_REF_DSETREG, H5S_ALL, H5S_ALL,
                 H5P_DEFAULT, ref);
```

Example 9. Write the array of references to a dataset

When creating region references, the following rules are enforced.

- The selection must be a valid selection for the target *dataset*, just as when transferring data
- The *dataset* must exist in the file when the reference is created (H5Rcreate)
- The target *dataset* must be in the same file as the stored reference

7.6.3. Reading References to Regions

To retrieve data from a region reference, the reference must be read from the file, and then the data can be retrieved. The steps are:

1. Open the dataset or attribute containing the reference objects
2. Read the reference object(s)
3. For each region reference, get the dataset (H5R_dereference) and dataspace (H5Rget_space)
4. Use the dataspace and datatype to discover what space is needed to store the data, allocate the correct storage and create a dataspace and datatype to define the memory data layout

The example below shows code to read an array of region references from a dataset, and then read the data from the first selected region. Note that the region reference has information that records the dataset (within the file) and the selection on the *dataspace* of the *dataset*. After dereferencing the regions reference, the *datatype*, number of points, and some aspects of the selection can be discovered. (For a union of hyperslabs, it may not be possible to determine the exact set of hyperslabs that has been combined.) The table below the code example shows the inquiry functions.

When reading data from a region reference, the following rules are enforced:

- The target *dataset* must be present and accessible in the file
- The selection must be a valid selection for the *dataset*

```

dsetr_id = H5Dopen (file_id, "R1", H5P_DEFAULT);

status = H5Dread(dsetr_id, H5T_STD_REF_DSETREG, H5S_ALL, H5S_ALL,
                H5P_DEFAULT, ref_out);

/*
 * Dereference the first reference.
 * 1) get the dataset (H5Rdereference)
 * 2) get the selected dataspace (H5Rget_region)
 */
dsetv_id = H5Rdereference(dsetr_id, H5R_DATASET_REGION,
                          &ref_out[0]);
space_id = H5Rget_region(dsetr_id, H5R_DATASET_REGION,&ref_out[0]);

/*
 * Discover how many points and shape of the data
 */
ndims = H5Sget_simple_extent_ndims(space_id);

H5Sget_simple_extent_dims(space_id,dimsx,NULL);

/*
 * Read and display hyperslab selection from the dataset.
 */
dimy[0] = H5Sget_select_npoints(space_id);
spacex_id = H5Screate_simple(1, dimsy, NULL);

status = H5Dread(dsetv_id, H5T_NATIVE_INT, H5S_ALL, space_id,
                H5P_DEFAULT, data_out);
printf("Selected hyperslab: ");
for (i = 0; i < 8; i++)
{
    printf("\n");
    for (j = 0; j < 10; j++)
        printf("%d ", data_out[i][j]);
}
printf("\n");

```

Example 10. Read an array of region references, and then read from the first selection

Table 3. The inquiry functions

Function	Information
H5Sget_select_npoints	The number of elements in the selection (hyperslab or point selection).
H5Sget_select_bounds	The bounding box that encloses the selected points (hyperslab or point selection).
H5Sget_select_hyper_nblocks	The number of blocks in the selection.
H5Sget_select_hyper_blocklist	A list of the blocks in the selection.
H5Sget_select_elem_npoints	The number of points in the selection.
H5Sget_select_elem_pointlist	The points.

7.7. Sample Programs

This section contains the full programs from which several of the code examples in this chapter were derived. The h5dump output from the program's output file immediately follows each program.

7.7.1. h5_write.c

```

-----
#include "hdf5.h"

#define H5FILE_NAME      "SDS.h5"
#define DATASETNAME     "C Matrix"
#define NX              3          /* dataset dimensions */
#define NY              5
#define RANK            2

int
main (void)
{
    hid_t      file, dataset;          /* file and dataset identifiers */
    hid_t      datatype, dataspace;   /* identifiers */
    hsize_t    dims[2];               /* dataset dimensions */
    herr_t     status;
    int        data[NX][NY];          /* data to write */
    int        i, j;

    /*
     * Data and output buffer initialization.
     */
    for (j = 0; j < NX; j++) {
        for (i = 0; i < NY; i++)
            data[j][i] = i + 1 + j*NY;
    }
    /*
     *  1  2  3  4  5
     *  6  7  8  9 10
     * 11 12 13 14 15
     */

    /*
     * Create a new file using H5F_ACC_TRUNC access,
     * default file creation properties, and default file
     * access properties.
     */
    file = H5Fcreate(H5FILE_NAME, H5F_ACC_TRUNC, H5P_DEFAULT, H5P_DEFAULT);

    /*
     * Describe the size of the array and create the data space for fixed
     * size dataset.
     */
    dims[0] = NX;
    dims[1] = NY;
    dataspace = H5Screate_simple(RANK, dims, NULL);

    /*
     * Create a new dataset within the file using defined dataspace and
     * datatype and default dataset creation properties.
     */
    dataset = H5Dcreate(file, DATASETNAME, H5T_NATIVE_INT, dataspace,
                       H5P_DEFAULT, H5P_DEFAULT, H5P_DEFAULT);
}

```

```

/*
 * Write the data to the dataset using default transfer properties.
 */
status = H5Dwrite(dataset, H5T_NATIVE_INT, H5S_ALL, H5S_ALL,
                 H5P_DEFAULT, data);

/*
 * Close/release resources.
 */
H5Sclose(dataspace);
H5Dclose(dataset);
H5Fclose(file);

return 0;
}

```

SDS.out

```

-----
HDF5 "SDS.h5" {
GROUP "/" {
  DATASET "C Matrix" {
    DATATYPE H5T_STD_I32BE
    DATASPACE SIMPLE { ( 3, 5 ) / ( 3, 5 ) }
    DATA {
      1, 2, 3, 4, 5,
      6, 7, 8, 9, 10,
      11, 12, 13, 14, 15
    }
  }
}
}
}

```

7.7.2. h5_write.f90

```

-----
PROGRAM DSETEXAMPLE

```

```

USE HDF5 ! This module contains all necessary modules

```

```

IMPLICIT NONE

```

```

CHARACTER(LEN=7), PARAMETER :: filename = "SDSf.h5" ! File name
CHARACTER(LEN=14), PARAMETER :: dsetname = "Fortran Matrix" ! Dataset name
INTEGER, PARAMETER :: NX = 3
INTEGER, PARAMETER :: NY = 5

```

```

INTEGER(HID_T) :: file_id      ! File identifier
INTEGER(HID_T) :: dset_id     ! Dataset identifier
INTEGER(HID_T) :: dspace_id   ! Dataspace identifier

```

```

INTEGER(HSIZE_T), DIMENSION(2) :: dims = (/3,5/) ! Dataset dimensions
INTEGER      :: rank = 2                ! Dataset rank
INTEGER      :: data(NX,NY)

```

```

INTEGER      :: error ! Error flag

```



```

INTEGER      :: i, j

!
! Initialize data
!
do i = 1, NX
  do j = 1, NY
    data(i,j) = j + (i-1)*NY
  enddo
enddo
!
! Data
!
!  1  2  3  4  5
!  6  7  8  9 10
! 11 12 13 14 15

!
! Initialize FORTRAN interface.
!
CALL h5open_f(error)

!
! Create a new file using default properties.
!
CALL h5fcreate_f(filename, H5F_ACC_TRUNC_F, file_id, error)

!
! Create the dataspace.
!
CALL h5screate_simple_f(rank, dims, dspace_id, error)

!
! Create and write dataset using default properties.
!
CALL h5dcreate_f(file_id, dsetname, H5T_NATIVE_INTEGER, dspace_id, &
                dset_id, error, H5P_DEFAULT_F, H5P_DEFAULT_F, &
                H5P_DEFAULT_F)

CALL h5dwrite_f(dset_id, H5T_NATIVE_INTEGER, data, dims, error)

!
! End access to the dataset and release resources used by it.
!
CALL h5dclose_f(dset_id, error)

!
! Terminate access to the data space.
!
CALL h5sclose_f(dspace_id, error)

!
! Close the file.
!
CALL h5fclose_f(file_id, error)

!
! Close FORTRAN interface.
!
CALL h5close_f(error)

```

```
END PROGRAM DSETEXAMPLE
```

```
SDSf.out
```

```
-----
```

```
HDF5 "SDSf.h5" {
GROUP "/" {
  DATASET "Fortran Matrix" {
    DATATYPE H5T_STD_I32BE
    DATASPACE SIMPLE { ( 5, 3 ) / ( 5, 3 ) }
    DATA {
      1, 6, 11,
      2, 7, 12,
      3, 8, 13,
      4, 9, 14,
      5, 10, 15
    }
  }
}
}
```

7.7.3. h5_write_tr.f90

```
-----
```

```
PROGRAM DSETEXAMPLE
```

```
USE HDF5 ! This module contains all necessary modules
```

```
IMPLICIT NONE
```

```
CHARACTER(LEN=10), PARAMETER :: filename = "SDSf_tr.h5" ! File name
CHARACTER(LEN=24), PARAMETER :: dsetname = "Fortran Transpose Matrix"
                                     ! Dataset name
```

```
INTEGER, PARAMETER :: NX = 3
INTEGER, PARAMETER :: NY = 5
```

```
INTEGER(HID_T) :: file_id      ! File identifier
INTEGER(HID_T) :: dset_id     ! Dataset identifier
INTEGER(HID_T) :: dspace_id   ! Dataspace identifier
```

```
INTEGER(HSIZE_T), DIMENSION(2) :: dims = (/NY, NX/) ! Dataset dimensions
INTEGER      :: rank = 2                ! Dataset rank
INTEGER      :: data(NY,NX)
```

```
INTEGER      :: error ! Error flag
INTEGER      :: i, j
```

```
!
! Initialize data
!
do i = 1, NY
  do j = 1, NX
    data(i,j) = i + (j-1)*NY
  enddo
enddo
!
! Data
!
```

```
! 1 6 11
! 2 7 12
! 3 8 13
! 4 9 14
! 5 10 15

!
! Initialize FORTRAN interface.
!
CALL h5open_f(error)

!
! Create a new file using default properties.
!
CALL h5fcreate_f(filename, H5F_ACC_TRUNC_F, file_id, error)

!
! Create the dataspace.
!
CALL h5screate_simple_f(rank, dims, dspace_id, error)

!
! Create and write dataset using default properties.
!
CALL h5dcreate_f(file_id, dsetname, H5T_NATIVE_INTEGER, dspace_id, &
                dset_id, error, H5P_DEFAULT_F, H5P_DEFAULT_F, &
                H5P_DEFAULT_F)

CALL h5dwrite_f(dset_id, H5T_NATIVE_INTEGER, data, dims, error)

!
! End access to the dataset and release resources used by it.
!
CALL h5dclose_f(dset_id, error)

!
! Terminate access to the data space.
!
CALL h5sclose_f(dspace_id, error)

!
! Close the file.
!
CALL h5fclose_f(file_id, error)

!
! Close FORTRAN interface.
!
CALL h5close_f(error)

END PROGRAM DSETEXAMPLE
```

```
SDSf_tr.out
-----
HDF5 "SDSf_tr.h5" {
GROUP "/" {
  DATASET "Fortran Transpose Matrix" {
    DATATYPE  H5T_STD_I32LE
    DATASPACE SIMPLE { ( 3, 5 ) / ( 3, 5 ) }
    DATA {
      1, 2, 3, 4, 5,
      6, 7, 8, 9, 10,
      11, 12, 13, 14, 15
    }
  }
}
}
```

Chapter 8

HDF5 Attributes

8.1. Introduction

An HDF5 attribute is a small metadata object describing the nature and/or intended usage of a primary data object. A primary data object may be a dataset, group, or committed datatype.

Attributes are assumed to be very small as data objects go, so storing them as standard HDF5 datasets would be quite inefficient. HDF5 attributes are therefore managed through a special attributes interface, H5A, which is designed to easily attach attributes to primary data objects as small datasets containing metadata information and to minimize storage requirements.

Consider, as examples of the simplest case, a set of laboratory readings taken under known temperature and pressure conditions of 18.0 degrees celsius and 0.5 atmospheres, respectively. The temperature and pressure stored as attributes of the dataset could be described as the following name/value pairs:

```
temp=18.0  
pressure=0.5
```

While HDF5 attributes are not standard HDF5 datasets, they have much in common:

- An attribute has a user-defined dataspace and the included metadata has a user-assigned datatype
- Metadata can be of any valid HDF5 datatype
- Attributes are addressed by name

But there are some very important differences:

- There is no provision for special storage such as compression or chunking
- There is no partial I/O or sub-setting capability for attribute data
- Attributes cannot be shared
- Attributes cannot have attributes
- Being small, an attribute is stored in the object header of the object it describes and is thus attached directly to that object

The “Special Issues” section below describes how to handle attributes that are large in size and how to handle large numbers of attributes.

This chapter discusses or lists the following:

- The HDF5 attributes programming model
- H5A function summaries
- Working with HDF5 attributes
 - ◆ The structure of an attribute
 - ◆ Creating, writing, and reading attributes
 - ◆ Accessing attributes by name or index
 - ◆ Obtaining information regarding an object's attributes
 - ◆ Iterating across an object's attributes
 - ◆ Deleting an attribute
 - ◆ Closing attributes
- Special issues regarding attributes

In the following discussions, attributes are generally attached to datasets. Attributes attached to other primary data objects, i.e., groups or committed datatypes, are handled in exactly the same manner.

8.2. Programming Model

The figure below shows the UML model for an HDF5 attribute and its associated dataspace and datatype.

8.2.1. To Create and Write a New Attribute

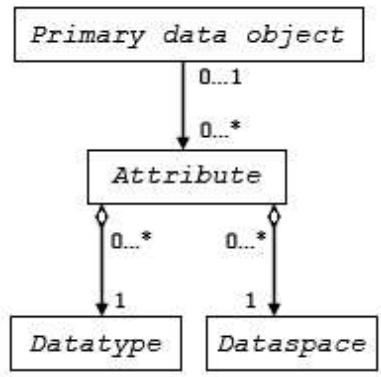

Figure 1. The UML model for an HDF5 attribute

Creating an attribute is similar to creating a dataset. To create an attribute, the application must specify the object to which the attribute is attached, the datatype and dataspace of the attribute data, and the attribute creation property list.

The following steps are required to create and write an HDF5 attribute:

1. Obtain the object identifier for the attribute's primary data object
2. Define the characteristics of the attribute and specify the attribute creation property list
 - ◆ Define the datatype
 - ◆ Define the dataspace
 - ◆ Specify the attribute creation property list
3. Create the attribute
4. Write the attribute data (optional)
5. Close the attribute (and datatype, dataspace, and attribute creation property list, if necessary)
6. Close the primary data object (if appropriate)

8.2.2. To Open and Read or Write an Existing Attribute

The following steps are required to open and read/write an existing attribute. Since HDF5 attributes allow no partial I/O, you need specify only the attribute and the attribute's memory datatype to read it:

1. Obtain the object identifier for the attribute's primary data object
2. Obtain the attribute's name or index
3. Open the attribute
 - ◆ Get attribute dataspace and datatype (optional)
4. Specify the attribute's memory type
5. Read and/or write the attribute data
6. Close the attribute
7. Close the primary data object (if appropriate)

8.3. Attribute (H5A) Function Summaries

Functions that can be used with attributes (H5A functions) and functions that can be used with property lists (H5P functions) are listed below.

Function Listing 1. Attribute functions (H5A)

C Function	Purpose
Fortran Function	
H5Acreate h5acreate_f	Creates a dataset as an attribute of another group, dataset, or committed datatype. The C function is a macro: see “API Compatibility Macros in HDF5.”
H5Acreate_by_name h5acreate_by_name_f	Creates an attribute attached to a specified object.
H5Aexists h5aexists_f	Determines whether an attribute with a given name exists on an object.
H5Aexists_by_name h5aexists_by_name_f	Determines whether an attribute with a given name exists on an object.
H5Aclose h5aclose_f	Closes the specified attribute.
H5Adelete h5adelete_f	Deletes an attribute.
H5Adelete_by_idx h5adelete_by_idx_f	Deletes an attribute from an object according to index order.
H5Adelete_by_name h5adelete_by_name_f	Removes an attribute from a specified location.
H5Aget_create_plist h5aget_create_plist_f	Gets an attribute creation property list identifier.
H5Aget_info h5aget_info_f	Retrieves attribute information by attribute identifier.
H5Aget_info_by_idx h5aget_info_by_idx_f	Retrieves attribute information by attribute index position.
H5Aget_info_by_name h5aget_info_by_name_f	Retrieves attribute information by attribute name.
H5Aget_name h5aget_name_f	Gets an attribute name.
H5Aget_name_by_idx h5aget_name_by_idx_f	Gets an attribute name by attribute index position.
H5Aget_space h5aget_space_f	Gets a copy of the dataspace for an attribute.
H5Aget_storage_size h5aget_storage_size_f	Returns the amount of storage required for an attribute.
H5Aget_type h5aget_type_f	Gets an attribute datatype.

H5Aiterate (none)	Calls a user's function for each attribute attached to a data object. The C function is a macro: see "API Compatibility Macros in HDF5."
H5Aiterate_by_name (none)	Calls user-defined function for each attribute on an object.
H5Aopen h5aopen_f	Opens an attribute for an object specified by object identifier and attribute name.
H5Aopen_by_idx h5aopen_by_idx_f	Opens an existing attribute that is attached to an object specified by location and name.
H5Aopen_by_name h5aopen_by_name_f	Opens an attribute for an object by object name and attribute name.
H5Aread h5aread_f	Reads an attribute.
H5Arename h5arename_f	Renames an attribute.
H5Arename_by_name h5arename_by_name_f	Renames an attribute.
H5Awrite H5awrite_f	Writes an attribute.

Function Listing 2. Attribute creation property list functions (H5P)

C Function	Purpose
Fortran Function	
H5Pset_char_encoding h5pset_char_encoding_f	Sets the character encoding used to encode a string. Use to set ASCII or UTF-8 character encoding for object names.
H5Pget_char_encoding h5pget_char_encoding_f	Retrieves the character encoding used to create a string.
H5Pget_attr_creation_order h5pget_attr_creation_order_f	Retrieves tracking and indexing settings for attribute creation order.
H5Pget_attr_phase_change h5pget_attr_phase_change_f	Retrieves attribute storage phase change thresholds.
H5Pset_attr_creation_order h5pset_attr_creation_order_f	Sets tracking and indexing of attribute creation order.
H5Pset_attr_phase_change h5pset_attr_phase_change_f	Sets attribute storage phase change thresholds.

8.4. Working with Attributes

8.4.1. The Structure of an Attribute

An attribute has two parts: name and value(s)

HDF5 attributes are sometimes discussed as name/value pairs in the form `name=value`.

An attribute's name is a null-terminated ASCII character string. Each attribute attached to an object has a unique name.

The value portion of the attribute contains one or more data elements of the same datatype.

HDF5 attributes have all the characteristics of HDF5 datasets except that there is no partial I/O capability. In other words, attributes can be written and read only in full with no sub-setting.

8.4.2. Creating, Writing, and Reading Attributes

If attributes are used in an HDF5 file, these functions will be employed: `H5Acreate`, `H5Awrite`, and `H5Aread`. `H5Acreate` and `H5Awrite` are used together to place the attribute in the file. If an attribute is to be used and is not currently in memory, `H5Aread` generally comes into play usually in concert with one each of the `H5Aget_*` and `H5Aopen_*` functions.

To create an attribute, call `H5Acreate`:

```
hid_t H5Acreate (hid_t loc_id, const char *name,
                hid_t type_id, hid_t space_id, hid_t create_plist,
                hid_t access_plist)
```

`loc_id` identifies the object (dataset, group, or committed datatype) to which the attribute is to be attached. `name`, `type_id`, `space_id`, and `create_plist` convey, respectively, the attribute's name, datatype, dataspace, and attribute creation property list. The attribute's name must be locally unique: it must be unique within the context of the object to which it is attached.

`H5Acreate` creates the attribute in memory. The attribute does not exist in the file until `H5Awrite` writes it there.

To write or read an attribute, call `H5Awrite` or `H5Aread`, respectively:

```
herr_t H5Awrite (hid_t attr_id, hid_t mem_type_id,
                const void *buf)
herr_t H5Aread (hid_t attr_id, hid_t mem_type_id,
                void *buf)
```

`attr_id` identifies the attribute while `mem_type_id` identifies the in-memory datatype of the attribute data.

`H5Awrite` writes the attribute data from the buffer `buf` to the file. `H5Aread` reads attribute data from the file into `buf`.

The HDF5 Library converts the metadata between the in-memory datatype, `mem_type_id`, and the in-file datatype, defined when the attribute was created, without user intervention.

8.4.3. Accessing Attributes by Name or Index

Attributes can be accessed by name or index value. The use of an index value makes it possible to iterate through all of the attributes associated with a given object.

To access an attribute by its name, use the `H5Aopen_by_name` function. `H5Aopen_by_name` returns an attribute identifier that can then be used by any function that must access an attribute such as `H5Aread`. Use the function `H5Aget_name` to determine an attribute's name.

To access an attribute by its index value, use the `H5Aopen_by_idx` function. To determine an attribute index value when it is not already known, use the `H5Oget_info` function. `H5Aopen_by_idx` is generally used in the course of opening several attributes for later access. Use `H5Aiterate` if the intent is to perform the same operation on every attribute attached to an object.

8.4.4. Obtaining Information Regarding an Object's Attributes

In the course of working with HDF5 attributes, one may need to obtain any of several pieces of information:

- An attribute name
- The dataspace of an attribute
- The datatype of an attribute
- The number of attributes attached to an object

To obtain an attribute's name, call `H5Aget_name` with an attribute identifier, `attr_id`:

```
ssize_t H5Aget_name (hid_t attr_id, size_t buf_size,
                    char *buf)
```

As with other attribute functions, `attr_id` identifies the attribute; `buf_size` defines the size of the buffer; and `buf` is the buffer to which the attribute's name will be read.

If the length of the attribute name, and hence the value required for `buf_size`, is unknown, a first call to `H5Aget_name` will return that size. If the value of `buf_size` used in that first call is too small, the name will simply be truncated in `buf`. A second `H5Aget_name` call can then be used to retrieve the name in an appropriately-sized buffer.

To determine the dataspace or datatype of an attribute, call `H5Aget_space` or `H5Aget_type`, respectively:

```
hid_t H5Aget_space (hid_t attr_id)
```

```
hid_t H5Aget_type (hid_t attr_id)
```

`H5Aget_space` returns the dataspace identifier for the attribute `attr_id`.

`H5Aget_type` returns the datatype identifier for the attribute `attr_id`.

To determine the number of attributes attached to an object, use the `H5Oget_info` function. The function signature is below.

```
herr_t H5Oget_info( hid_t object_id, H5O_info_t *object_info )
```

The number of attributes will be returned in the `object_info` buffer. This is generally the preferred first step in determining attribute index values. If the call returns `N`, the attributes attached to the object `object_id` have index values of 0 through `N - 1`.

8.4.5. Iterating across an Object's Attributes

It is sometimes useful to be able to perform the identical operation across all of the attributes attached to an object. At the simplest level, you might just want to open each attribute. At a higher level, you might wish to perform a rather complex operation on each attribute as you iterate across the set.

To iterate an operation across the attributes attached to an object, one must make a series of calls to `H5Aiterate`:

```
herr_t H5Aiterate (hid_t obj_id, H5_index_t index_type,
                  H5_iter_order_t order, hsize_t *n, H5A_operator2_t op,
                  void *op_data)
```

`H5Aiterate` successively marches across all of the attributes attached to the object specified in `loc_id`, performing the operation(s) specified in `op_func` with the data specified in `op_data` on each attribute.

When `H5Aiterate` is called, `index` contains the index of the attribute to be accessed in this call. When `H5Aiterate` returns, `index` will contain the index of the next attribute. If the returned `index` is the null pointer, then all attributes have been processed, and the iterative process is complete.

`op_func` is a user-defined operation that adheres to the `H5A_operator_t` prototype. This prototype and certain requirements imposed on the operator's behavior are described in the `H5Aiterate` entry in the *HDF5 Reference Manual*.

`op_data` is also user-defined to meet the requirements of `op_func`. Beyond providing a parameter with which to pass this data, HDF5 provides no tools for its management and imposes no restrictions.

8.4.6. Deleting an Attribute

Once an attribute has outlived its usefulness or is no longer appropriate, it may become necessary to delete it.

To delete an attribute, call `H5Adelete`:

```
herr_t H5Adelete (hid_t loc_id, const char *name)
```

`H5Adelete` removes the attribute name from the group, dataset, or committed datatype specified in `loc_id`.

`H5Adelete` must not be called if there are any open attribute identifiers on the object `loc_id`. Such a call can cause the internal attribute indexes to change; future writes to an open attribute would then produce unintended results.

8.4.7. Closing an Attribute

As is the case with all HDF5 objects, once access to an attribute it is no longer needed, that attribute must be closed. It is best practice to close it as soon as practicable; it is mandatory that it be closed prior to the `H5close` call closing the HDF5 Library.

To close an attribute, call `H5Aclose`:

```
herr_t H5Aclose (hid_t attr_id)
```

`H5Aclose` closes the specified attribute by terminating access to its identifier, `attr_id`.

8.5. Special Issues

Some special issues for attributes are discussed below.

Large Numbers of Attributes Stored in Dense Attribute Storage

The dense attribute storage scheme was added in version 1.8 so that datasets, groups, and committed datatypes that have large numbers of attributes could be processed more quickly.

Attributes start out being stored in an object's header. This is known as compact storage. See the “Datasets” chapter for more information on compact, contiguous, and chunked storage.

As the number of attributes grows, attribute-related performance slows. To improve performance, dense attribute storage can be initiated with the `H5Pset_attr_phase_change` function. See the *HDF5 Reference Manual* for more information.

When dense attribute storage is enabled, a threshold is defined for the number of attributes kept in compact storage. When the number is exceeded, the library moves all of the attributes into dense storage at another location. The library handles the movement of attributes and the pointers between the locations automatically. If some of the attributes are deleted so that the number falls below the threshold, then the attributes are moved back to compact storage by the library.

The improvements in performance from using dense attribute storage are the result of holding attributes in a heap and indexing the heap with a B-tree.

Note that there are some disadvantages to using dense attribute storage. One is that this is a new feature. Datasets, groups, and committed datatypes that use dense storage cannot be read by applications built with earlier versions of the library. Another disadvantage is that attributes in dense storage cannot be compressed.

Large Attributes Stored in Dense Attribute Storage

We generally consider the maximum size of an attribute to be 64K bytes. The library has two ways of storing attributes larger than 64K bytes: in dense attribute storage or in a separate dataset. Using dense attribute storage is described in this section, and storing in a separate dataset is described in the next section.

To use dense attribute storage to store large attributes, set the number of attributes that will be stored in compact storage to 0 with the `H5Pset_attr_phase_change` function. This will force all attributes to be put into dense attribute storage and will avoid the 64KB size limitation for a single attribute in compact attribute storage.

Large Attributes Stored in a Separate Dataset

In addition to dense attribute storage (see above), a large attribute can be stored in a separate dataset. In the figure below, DatasetA holds an attribute that is too large for the object header in Dataset1. By putting a pointer to DatasetA as an attribute in Dataset1, the attribute becomes available to those working with Dataset1.

This way of handling large attributes can be used in situations where backward compatibility is important and where compression is important. Applications built with versions before 1.8.x can read large attributes stored in separate datasets. Datasets can be compressed while attributes cannot.

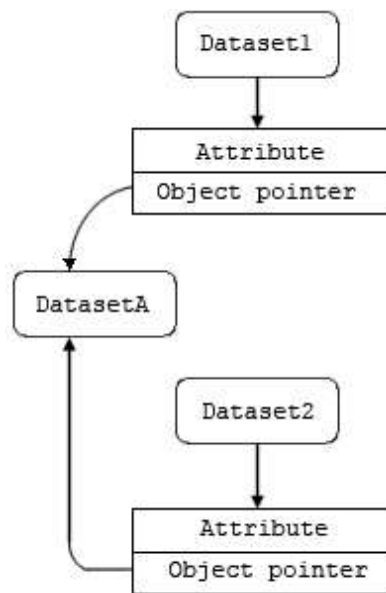

Figure 2. A large or shared HDF5 attribute and its associated dataset(s)
 DatasetA is an attribute of Dataset1 that is too large to store in Dataset1's header. DatasetA is associated with Dataset1 by means of an object reference pointer attached as an attribute to Dataset1. The attribute in DatasetA can be shared among multiple datasets by means of additional object reference pointers attached to additional datasets.

Shared Attributes

Attributes written and managed through the H5A interface cannot be shared. If shared attributes are required, they must be handled in the manner described above for large attributes and illustrated in the figure above.

Attribute Names

While any ASCII or UTF-8 character may be used in the name given to an attribute, it is usually wise to avoid the following kinds of characters:

- Commonly used separators or delimiters such as slash, backslash, colon, and semi-colon (\, /, :, ;)
- Escape characters
- Wild cards such as asterisk and question mark (*, ?)

NULL can be used within a name, but HDF5 names are terminated with a NULL: whatever comes after the NULL will be ignored by HDF5.

The use of ASCII or UTF-8 characters is determined by the character encoding property. See `H5Pset_char_encoding` in the *HDF5 Reference Manual*.

No Special I/O or Storage

HDF5 attributes have all the characteristics of HDF5 datasets except the following:

- Attributes are written and read only in full: there is no provision for partial I/O or sub-setting
- No special storage capability is provided for attributes: there is no compression or chunking, and attributes are not extendable

Chapter 9

HDF5 Error Handling

9.1. Introduction

The HDF5 Library provides an error reporting mechanism for both the library itself and for user application programs. It can trace errors through function stack and error information like file name, function name, line number, and error description.

Section 2 of this chapter discusses the HDF5 error handling programming model.

Section 3 presents summaries of HDF5's error handling functions.

Section 4 discusses the basic error concepts such as error stack, error record, and error message and describes the related API functions. These concepts and functions are sufficient for application programs to trace errors inside the HDF5 Library.

Section 5 talks about the advanced concepts of error class and error stack handle and talks about the related functions. With these concepts and functions, an application library or program using the HDF5 Library can have its own error report blended with HDF5's error report.

Starting with Release 1.8, we have a new set of Error Handling API functions. For the purpose of backward compatibility with version 1.6 and before, we still keep the old API functions, `H5Epush`, `H5Eprint`, `H5Ewalk`, `H5Eclear`, `H5Eget_auto`, `H5Eset_auto`. These functions do not have the error stack as parameter. The library allows them to operate on the default error stack. Users do not have to change their code to catch up with the new Error API but are encouraged to do so.

The old API is similar to functionality discussed in Section 4. The functionality discussed in Section 5, the ability of allowing applications to add their own error records, is the library new design for the Error API.

9.2. Programming Model

This section is under construction.

9.3. Error Handling (H5E) Function Summaries

Functions that can be used to handle errors (H5E functions) are listed below.

Function Listing 1. Error handling functions (H5E)

C Function	Purpose
Fortran Function	
H5Eauto_is_v2 (none)	Determines the type of error stack.
H5Eclear h5eclear_f	Clears the error stack for the current thread. The C function is a macro: see “API Compatibility Macros in HDF5.”
H5Eclear_stack (none)	Clears the error stack for the current thread.
H5Eclose_msg (none)	Closes an error message identifier.
H5Eclose_stack (none)	Closes object handle for error stack.
H5Ecreate_msg (none)	Add major error message to an error class.
H5Eget_auto h5eget_auto_f	Returns the current settings for the automatic error stack traversal function and its data. The C function is a macro: see “API Compatibility Macros in HDF5.”
H5Eget_class_name (none)	Retrieves error class name.
H5Eget_current_stack (none)	Registers the current error stack.
H5Eget_msg (none)	Retrieves an error message.
H5Eget_num (none)	Retrieves the number of error messages in an error stack.
H5Epop (none)	Deletes specified number of error messages from the error stack.
H5Eprint h5eprint_f	Prints the error stack in a default manner. The C function is a macro: see “API Compatibility Macros in HDF5.”
H5Epush (none)	Pushes new error record onto error stack. The C function is a macro: see “API Compatibility Macros in HDF5.”
H5Eregister_class (none)	Registers a client library or application program to the HDF5 error API.
H5Eset_auto h5eset_auto_f	Turns automatic error printing on or off. The C function is a macro: see “API Compatibility Macros in HDF5.”

H5Eset_current_stack (none)	Replaces the current error stack.
H5Eunregister_class (none)	Removes an error class.
H5Ewalk (none)	Walks the error stack for the current thread, calling a specified function. The C function is a macro: see “API Compatibility Macros in HDF5.”

9.4. Basic Error Handling Operations

9.4.1. Introduction

Let us first try to understand the error stack. An *error stack* is a collection of error records. Error records can be pushed onto or popped off the error stack. By default, when an error occurs deep within the HDF5 Library, an error record is pushed onto an error stack and that function returns a failure indication. Its caller detects the failure, pushes another record onto the stack, and returns a failure indication. This continues until the API function called by the application returns a failure indication. The next API function being called will reset the error stack. All HDF5 Library error records belong to the same error class (explained in Section 5).

9.4.2. Error Stack and Error Message

In normal circumstances, an error causes the stack to be printed on the standard error stream automatically. This automatic error stack is the library's default stack. For all the functions in this section, whenever an error stack ID is needed as a parameter, `H5E_DEFAULT` can be used to indicate the library's default stack. The first error record of the error stack, number #000, is produced by the API function itself and is usually sufficient to indicate to the application what went wrong.

Example: An Error Report

If an application calls `H5Tclose` on a predefined datatype, then the message in the example below is printed on the standard error stream. This is a simple error that has only one component, the API function; other errors may have many components.

```
HDF5-DIAG: Error detected in HDF5 (1.6.4) thread 0.
#000: H5T.c line 462 in H5Tclose(): predefined datatype
      major: Function argument
      minor: Bad value
```

Example 1. An error report

In the example above, we can see that an *error record* has a major message and a minor message. A *major message* generally indicates where the error happens. The location can be a dataset or a dataspace, for example. A *minor message* explains further details of the error. An example is “unable to open file”. Another specific detail about the error can be found at the end of the first line of each error record. This *error description* is usually added by the library designer to tell what exactly goes wrong. In the example above, the “predefined datatype” is an error description.

9.4.3. Print and Clear an Error Stack

Besides the automatic error report, the error stack can also be printed and cleared by the functions `H5Eprint()` and `H5Eclear_stack()`. If an application wishes to make explicit calls to `H5Eprint()` to print the error stack, the automatic printing should be turned off to prevent error messages from being displayed twice (see `H5Eset_auto()` below).

To print an error stack

```
herr_t H5Eprint(hid_t error_stack, FILE * stream)
```

This function prints the error stack specified by `error_stack` on the specified stream, `stream`. If the error stack is empty, a one-line message will be printed. The following is an example of such a message. This message would be generated if the error was in the HDF5 Library.

```
HDF5-DIAG: Error detected in HDF5 Library version: 1.5.62 thread 0.
```

To clear an error stack

```
herr_t H5Eclear_stack(hid_t error_stack)
```

The `H5Eclear_stack` function shown above clears the error stack specified by `error_stack`. `H5E_DEFAULT` can be passed in to clear the current error stack. The current stack is also cleared whenever an API function is called; there are certain exceptions to this rule such as `H5Eprint()`.

9.4.4. Mute Error Stack

Sometimes an application calls a function for the sake of its return value, fully expecting the function to fail; sometimes the application wants to call `H5Eprint()` explicitly. In these situations, it would be misleading if an error message were still automatically printed. Using the `H5Eset_auto()` function can control the automatic printing of error messages.

To enable or disable automatic printing of errors

```
herr_t H5Eset_auto(hid_t error_stack, H5E_auto_t func, void *client_data)
```

The `H5Eset_auto` function can be used to turn on or off the automatic printing of errors for the error stack specified by `error_stack`. When turned on (non-null `func` pointer), any API function which returns an error indication will first call `func`, passing it `client_data` as an argument. When the library is first initialized the auto printing function is set to `H5Eprint()` (cast appropriately) and `client_data` is the standard error stream pointer, `stderr`.

To see the current settings

```
herr_t H5Eget_auto(hid_t error_stack, H5E_auto_t * func, void **client_data  
)
```

The function above returns the current settings for the automatic error stack traversal function, `func`, and its data, `client_data`. If either or both of the arguments are null, then the value is not returned.

Example: Error Control

An application can temporarily turn off error messages while “probing” a function. See the example below.

```

/* Save old error handler */
herr_t (*old_func)(void*);
void *old_client_data;

H5Eget_auto(error_stack, &old_func, &old_client_data);

/* Turn off error handling */
H5Eset_auto(error_stack, NULL, NULL);

/* Probe. Likely to fail, but that's okay */
status = H5Fopen (.....);

/* Restore previous error handler */
H5Eset_auto(error_stack, old_func, old_client_data);

```

Example 2. Turn off error messages while probing a function

Or automatic printing can be disabled altogether and error messages can be explicitly printed.

```

/* Turn off error handling permanently */
H5Eset_auto(error_stack, NULL, NULL);

/* If failure, print error message */
if (H5Fopen (.....)<0) {
    H5Eprint(H5E_DEFAULT, stderr);
    exit (1);
}

```

Example 3. Disable automatic printing and explicitly print error messages

9.4.5. Customized Printing of an Error Stack

Applications are allowed to define an automatic error traversal function other than the default `H5Eprint()`. For instance, one can define a function that prints a simple, one-line error message to the standard error stream and then exits. The first example below defines a such a function. The second example below installs the function as the error handler.

```

herr_t
my_hdf5_error_handler(void *unused)
{
    fprintf (stderr, "An HDF5 error was detected. Bye.\n");
    exit (1);
}

```

Example 4. Defining a function to print a simple error message

```
H5Eset_auto(H5E_DEFAULT, my_hdf5_error_handler, NULL);
```

Example 5. The user-defined error handler

9.4.6. Walk through the Error Stack

The `H5Eprint()` function is actually just a wrapper around the more complex `H5Ewalk()` function which traverses an error stack and calls a user-defined function for each member of the stack. The example below shows how `H5Ewalk` is used.

```
herr_t H5Ewalk(hid_t err_stack, H5E_direction_t direction, H5E_walk_t func,
void *client_data)
```

The error stack `err_stack` is traversed and `func` is called for each member of the stack. Its arguments are an integer sequence number beginning at zero (regardless of `direction`) and the `client_data` pointer. If `direction` is `H5E_WALK_UPWARD`, then traversal begins at the inner-most function that detected the error and concludes with the API function. Use `H5E_WALK_DOWNWARD` for the opposite order.

9.4.7. Traverse an Error Stack with a Callback Function

An error stack traversal callback function takes three arguments: `n` is a sequence number beginning at zero for each traversal, `eptr` is a pointer to an error stack member, and `client_data` is the same pointer used in the example above passed to `H5Ewalk()`. See the example below.

```
typedef herr_t (*H5E_walk_t)(unsigned n, H5E_error2_t *eptr, void
*client_data)
```

The `H5E_error2_t` structure is shown below.

```
typedef struct {
    hid_t      cls_id;
    hid_t      maj_num;
    hid_t      min_num;
    unsigned   line;
    const char *func_name;
    const char *file_name;
    const char *desc;
} H5E_error2_t;
```

The `maj_num` and `min_num` are major and minor error IDs, `func_name` is the name of the function where the error was detected, `file_name` and `line` locate the error within the HDF5 Library source code, and `desc` points to a description of the error.

Example: Callback Function

The following example shows a user-defined callback function.

```

#define MSG_SIZE      64

herr_t
custom_print_cb(unsigned n, const H5E_error2_t *err_desc, void* client_data)
{
    FILE          *stream = (FILE *)client_data;
    char          maj[MSG_SIZE];
    char          min[MSG_SIZE];
    char          cls[MSG_SIZE];
    const int     indent = 4;

    /* Get descriptions for the major and minor error numbers */
    if(H5Eget_class_name(err_desc->cls_id, cls, MSG_SIZE)<0)
        TEST_ERROR;

    if(H5Eget_msg(err_desc->maj_num, NULL, maj, MSG_SIZE)<0)
        TEST_ERROR;

    if(H5Eget_msg(err_desc->min_num, NULL, min, MSG_SIZE)<0)
        TEST_ERROR;

    fprintf (stream, "%*serror #03d: %s in %s(): line %u\n",
            indent, "", n, err_desc->file_name,
            err_desc->func_name, err_desc->line);
    fprintf (stream, "%*sclass: %s\n", indent*2, "", cls);
    fprintf (stream, "%*smajor: %s\n", indent*2, "", maj);
    fprintf (stream, "%*sminor: %s\n", indent*2, "", min);

    return 0;

error:
    return -1;
}

```

Example 6. A user-defined callback function

9.5. Advanced Error Handling Operations

9.5.1. Introduction

Section 4 discusses the basic error handling operations of the library. In that section, all the error records on the error stack are from the library itself. In this section, we are going to introduce the operations that allow an application program to push its own error records onto the error stack once it declares an error class of its own through the HDF5 Error API.

Example: An Error Report

An error report shows both the library's error record and the application's error records. See the example below.

```
Error Test-DIAG: Error detected in Error Program (1.0) thread 8192:
#000: ../../hdf5/test/error_test.c line 468 in main(): Error test failed
      major: Error in test
      minor: Error in subroutine
#001: ../../hdf5/test/error_test.c line 150 in test_error(): H5Dwrite failed
      as supposed to
      major: Error in IO
      minor: Error in H5Dwrite
HDF5-DIAG: Error detected in HDF5 (1.7.5) thread 8192:
#002: ../../hdf5/src/H5Dio.c line 420 in H5Dwrite(): not a dataset
      major: Invalid arguments to routine
      minor: Inappropriate type
```

Example 7. An error report

In the line above error record #002 in the example above, the starting phrase is HDF5. This is the error class name of the HDF5 Library. All of the library's error messages (major and minor) are in this default error class. The `Error Test` in the beginning of the line above error record #000 is the name of the application's error class. The first two error records, #000 and #001, are from application's error class.

By definition, an error class is a group of major and minor error messages for a library (the HDF5 Library or an application library built on top of the HDF5 Library) or an application program. The error class can be registered for a library or program through the HDF5 Error API. Major and minor messages can be defined in an error class. An application will have object handles for the error class and for major and minor messages for further operation. See the example below.

```
#define MSG_SIZE      64

herr_t
custom_print_cb(unsigned n, const H5E_error2_t *err_desc, void* client_data)
{
    FILE          *stream = (FILE *)client_data;
    char          maj[MSG_SIZE];
    char          min[MSG_SIZE];
    char          cls[MSG_SIZE];
    const int     indent = 4;

    /* Get descriptions for the major and minor error numbers */
    if(H5Eget_class_name(err_desc->cls_id, cls, MSG_SIZE)<0)
```

```

        TEST_ERROR;

    if(H5Eget_msg(err_desc->maj_num, NULL, maj, MSG_SIZE)<0)
        TEST_ERROR;

    if(H5Eget_msg(err_desc->min_num, NULL, min, MSG_SIZE)<0)
        TEST_ERROR;

    fprintf (stream, "%*serror #03d: %s in %s(): line %u\n",
            indent, "", n, err_desc->file_name,
            err_desc->func_name, err_desc->line);
    fprintf (stream, "%*sclass: %s\n", indent*2, "", cls);
    fprintf (stream, "%*smajor: %s\n", indent*2, "", maj);
    fprintf (stream, "%*sminor: %s\n", indent*2, "", min);

    return 0;

error:
    return -1;
}

```

Example 8. Defining an error class

9.5.2. More Error API Functions

The Error API has functions that can be used to register or unregister an error class, to create or close error messages, and to query an error class or error message. These functions are illustrated below.

To register an error class

```
hid_t H5Eregister_class(const char* cls_name, const char* lib_name, const char* version)
```

This function registers an error class with the HDF5 Library so that the application library or program can report errors together with the HDF5 Library.

To add an error message to an error class

```
hid_t H5Ecreate_msg(hid_t class, H5E_type_t msg_type, const char* msg)
```

This function adds an error message to an error class defined by an application library or program. The error message can be either major or minor which is indicated by parameter *msg_type*.

To get the name of an error class

```
ssize_t H5Eget_class_name(hid_t class_id, char* name, size_t size)
```

This function retrieves the name of the error class specified by the class ID.

To retrieve an error message

```
ssize_t H5Eget_msg(hid_t mesg_id, H5E_type_t* mesg_type, char* mesg, size_t
size)
```

This function retrieves the error message including its length and type.

To close an error message

```
herr_t H5Eclose_msg(hid_t mesg_id)
```

This function closes an error message.

To remove an error class

```
herr_t H5Eunregister_class(hid_t class_id)
```

This function removes an error class from the Error API.

Example: Error Class and its Message

The example below shows how an application creates an error class and error messages.

```
/* Create an error class */
class_id = H5Eregister_class(ERR_CLS_NAME, PROG_NAME, PROG_VERS);

/* Retrieve class name */
H5Eget_class_name(class_id, cls_name, cls_size);

/* Create a major error message in the class */
maj_id = H5Ecreate_msg(class_id, H5E_MAJOR, "... ...");

/* Create a minor error message in the class */
min_id = H5Ecreate_msg(class_id, H5E_MINOR, "... ...");
```

Example 9. Create an error class and error messages

The example below shows how an application closes error messages and unregisters the error class.

```
H5Eclose_msg(maj_id);
H5Eclose_msg(min_id);
H5Eunregister_class(class_id);
```

Example 10. Closing error messages and unregistering the error class

9.5.3. Pushing an Application Error Message onto Error Stack

An application can push error records onto or pop error records off of the error stack just as the library does internally. An error stack can be registered, and an object handle can be returned to the application so that the application can manipulate a registered error stack.

To register the current stack

```
hid_t H5Eget_current_stack(void)
```

This function registers the current error stack, returns an object handle, and clears the current error stack. An empty error stack will also be assigned an ID.

To replace the current error stack with another

```
herr_t H5Eset_current_stack(hid_t error_stack)
```

This function replaces the current error stack with another error stack specified by `error_stack` and clears the current error stack. The object handle `error_stack` is closed after this function call.

To push a new error record to the error stack

```
herr_t H5Epush(hid_t error_stack, const char* file, const char* func,
unsigned line, hid_t cls_id, hid_t major_id, hid_t minor_id, const char*
desc, ... )
```

This function pushes a new error record onto the error stack for the current thread.

To delete some error messages

```
herr_t H5Epop(hid_t error_stack, size_t count)
```

This function deletes some error messages from the error stack.

To retrieve the number of error records

```
int H5Eget_num(hid_t error_stack)
```

This function retrieves the number of error records from an error stack.

To clear the error stack

```
herr_t H5Eclear_stack(hid_t error_stack)
```

This function clears the error stack.

To close the object handle for an error stack

```
herr_t H5Eclose_stack(hid_t error_stack)
```

This function closes the object handle for an error stack and releases its resources.

Example: Working with an Error Stack

The example below shows how an application pushes an error record onto the default error stack.

```

/* Make call to HDF5 I/O routine */
if((dset_id=H5Dopen(file_id, dset_name, access_plist))<0)
{
    /* Push client error onto error stack */
    H5Epush(H5E_DEFAULT,__FILE__,FUNC,__LINE__,cls_id,CLIENT_ERR_MAJ_IO,
           CLIENT_ERR_MINOR_OPEN,"H5Dopen failed");

    /* Indicate error occurred in function */
    return(0);
}

```

Example 11. Pushing an error message to an error stack

The example below shows how an application registers the current error stack and creates an object handle to avoid another HDF5 function from clearing the error stack.

```

if(H5Dwrite(dset_id, mem_type_id, mem_space_id, file_space_id, dset_xfer_plist_id, buf)<0)
{
    /* Push client error onto error stack */
    H5Epush(H5E_DEFAULT,__FILE__,FUNC,__LINE__,cls_id,CLIENT_ERR_MAJ_IO,
           CLIENT_ERR_MINOR_HDF5,"H5Dwrite failed");

    /* Preserve the error stack by assigning an object handle to it */
    error_stack = H5Eget_current_stack();

    /* Close dataset */
    H5Dclose(dset_id);

    /* Replace the current error stack with the preserved one */
    H5Eset_current_stack(error_stack);

    Return(0);
}

```

Example 12. Registering the error stack

Part III

Additional Resources

Chapter 10

Additional Resources

This chapter provides supplemental material for the *HDF5 User's Guide*.

To see code examples by API, go to the *HDF5 Examples* page at this address:

<http://www.hdfgroup.org/ftp/HDF5/examples/examples-by-api/>

For more information on how to manage the metadata cache and how to configure it for better performance, go to the *Metadata Caching in HDF5* page at this address:

<http://www.hdfgroup.org/hdf5/doc/Advanced/MetadataCache/index.html>

A number of functions are macros. For more information on how to use the macros, see the *API Compatibility Macros in HDF5* page at this address:

<http://www.hdfgroup.org/HDF5/doc/RM/APICompatMacros.html>

The following sections are included in this chapter:

- *Using Identifiers* - describes how identifiers behave and how they should be treated
- *Chunking in HDF5* - describes chunking storage and how it can be used to improve performance
- *HDF5 Glossary and Terms*

10.1. Using Identifiers

The purpose of this section is to describe how identifiers behave and how they should be treated by application programs.

When an application program uses the HDF5 library to create or open an item, a unique identifier is returned. The items that return a unique identifier when they are created or opened include the following: dataset, group, datatype, dataspace, file, attribute, property list, referenced object, error stack, and error message.

An application may open one of the items listed above more than once at the same time. For example, an application might open a group twice, receiving two identifiers. Information from one dataset in the group could be handled through one identifier, and the information from another dataset in the group is handled by a different identifier.

An application program should track every identifier it receives as a result of creating or opening one of the items listed above. In order for an application to close properly, it must release every identifier it has opened. If an application opened a group twice for example, it would need to issue two `H5Gclose` commands, one for each identifier. Not releasing identifiers causes resource leaks. Until an identifier is released, the item associated with the identifier is still open.

The library considers a file open until all of the identifiers associated with the file and with the file's various items have been released. The identifiers associated with these open items must be released separately. This means that an application can close a file and still work with one or more portions of the file. Suppose an application opened a file, a group within the file, and two datasets within the group. If the application closed the file with `H5Fclose`, then the file would be considered closed to the application, but the group and two datasets would still be open.

There are several exceptions to the above file closing rule. One is when the `H5close` function is used instead of `H5Fclose`. `H5close` causes a general shutdown of the library: all data is written to disk, all identifiers are closed, and all memory used by the library is cleaned up. Another exception occurs on parallel processing systems. Suppose on a parallel system an application has opened a file, a group in the file, and two datasets in the group. If the application uses the `H5Fclose` function to close the file, the call will fail with an error. The open group and datasets must be closed before the file can be closed. A third exception is when the file access property list includes the property `H5F_CLOSE_STRONG`. This property causes the closing of all of the file's open items when the file is closed with `H5Fclose`.

For more information about `H5close`, `H5Fclose`, and `H5Pset_fclose_degree`, see the *HDF5 Reference Manual*.

Functions that Return Identifiers

Some of the functions that return identifiers are listed below.

- `H5Acreate`
- `H5Acreate_by_name`
- `H5Aget_type`
- `H5Aopen`
- `H5Aopen_by_idx`
- `H5Aopen_by_name`
- `H5Dcreate`

- H5Dcreate_anon
- H5Dget_access_plist
- H5Dget_create_plist
- H5Dget_space
- H5Dget_type
- H5Dopen
- H5Ecreate_msg
- H5Ecreate_stack
- H5Fcreate
- H5Fopen
- H5Freopen
- H5Gcreate
- H5Gcreate_anon
- H5Gopen
- H5Oopen
- H5Oopen_by_addr
- H5Oopen_by_idx
- H5Pcreate
- H5Rdereference
- H5Rget_region
- H5Screate
- H5Screate_simple
- H5Tcopy
- H5Tcreate
- H5Tdecode
- H5Tget_member_type
- H5Tget_super
- H5Topen

10.2. Chunking in HDF5

Datasets in HDF5 not only provide a convenient, structured, and self-describing way to store data, but are also designed to do so with good performance. In order to maximize performance, the HDF5 library provides ways to specify how the data is stored on disk, how it is accessed, and how it should be held in memory.

10.2.1. What are Chunks?

Datasets in HDF5 can represent arrays with any number of dimensions (up to 32). However, in the file this dataset must be stored as part of the 1-dimensional stream of data that is the low-level file. The way in which the multidimensional dataset is mapped to the serial file is called the layout. The most obvious way to accomplish this is to simply flatten the dataset in a way similar to how arrays are stored in memory, serializing the entire dataset into a monolithic block on disk, which maps directly to a memory buffer the size of the dataset. This is called a contiguous layout.

An alternative to the contiguous layout is the chunked layout. Whereas contiguous datasets are stored in a single block in the file, chunked datasets are split into multiple *chunks* which are all stored separately in the file. The chunks can be stored in any order and any position within the HDF5 file. Chunks can then be read and written individually, improving performance when operating on a subset of the dataset.

The API functions used to read and write chunked datasets are exactly the same functions used to read and write contiguous datasets. The only difference is a single call to set up the layout on a property list before the dataset is created. In this way, a program can switch between using chunked and contiguous datasets by simply altering that call. Example 1, below, creates a dataset with a size of 12x12 and a chunk size of 4x4. The example could be change to create a contiguous dataset instead by simply commenting out the call to `H5Pset_chunk`.

```

#include
int main(void) {
    hid_t          file_id, dset_id, space_id, dcpl_id;
    hsize_t chunk_dims[2] = {4, 4};
    hsize_t dset_dims[2] = {12, 12};
    int          buffer[12][12];

    /* Create the file */
    file_id = H5Fcreate(file.h5, H5F_ACC_TRUNC, H5P_DEFAULT, H5P_DEFAULT);

    /* Create a dataset creation property list and set it to use chunking
    */
    dcpl_id = H5Pcreate(H5P_DATASET_CREATE);
    H5Pset_chunk(dcpl_id, 2, chunk_dims);

    /* Create the dataspace and the chunked dataset */
    space_id = H5Screate_simple(2, dset_dims, NULL);
    dset_id = H5Dcreate(file, dataset, H5T_NATIVE_INT, space_id, dcpl_id, H5P_DEFAULT);

    /* Write to the dataset */
    buffer =
    H5Dwrite(dset_id, H5T_NATIVE_INT, H5S_ALL, H5S_ALL, H5P_DEFAULT, buffer);

    /* Close */
    H5Dclose(dset_id);
    H5Sclose(space_id);
    H5Pclose(dcpl_id);
    H5Fclose(file_id);
    return 0;
}

```

Example 1. Creating a chunked dataset

The chunks of a chunked dataset are split along logical boundaries in the dataset's representation as an array, not along boundaries in the serialized form. Suppose a dataset has a chunk size of 2x2. In this case, the first chunk would go from (0,0) to (2,2), the second from (0,2) to (2,4), and so on. By selecting the chunk size carefully, it is possible to fine tune I/O to maximize performance for any access pattern. Chunking is also required to use advanced features such as compression and dataset resizing.

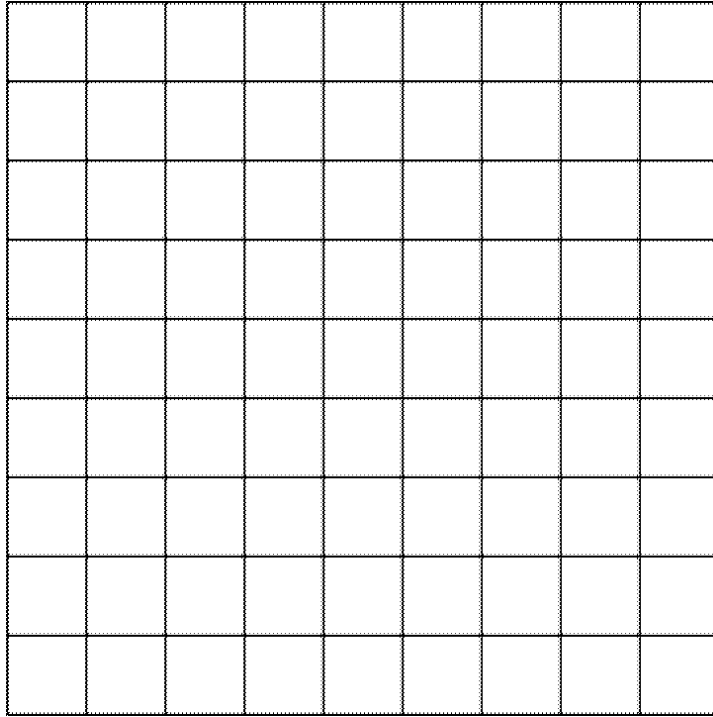

Figure 1. Contiguous dataset

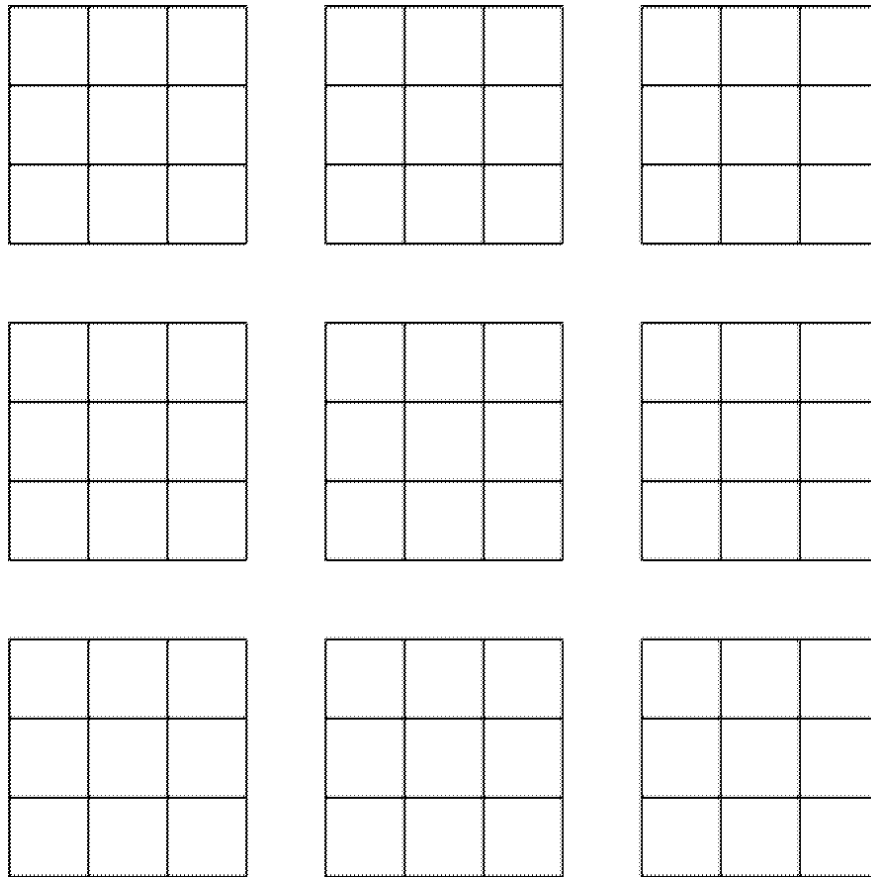

Figure 2. Chunked dataset

10.2.2. Data Storage Order

To understand the effects of chunking on I/O performance it is necessary to understand the order in which data is actually stored on disk. When using the C interface, data elements are stored in "row-major" order, meaning that, for a 2-dimensional dataset, rows of data are stored in-order on the disk. This is equivalent to the storage order of C arrays in memory.

Suppose we have a 10x10 contiguous dataset B. The first element stored on disk is $B[0][0]$, the second $B[0][1]$, the eleventh $B[1][0]$, and so on. If we want to read the elements from $B[2][3]$ to $B[2][7]$, we have to read the elements in the 24th, 25th, 26th, 27th, and 28th positions. Since all of these positions are contiguous, or next to each other, this can be done in a single read operation: read 5 elements starting at the 24th position. This operation is illustrated in figure 3: the pink cells represent elements to be read and the solid line represents a read operation. Now suppose we want to read the elements in the column from $B[3][2]$ to $B[7][2]$. In this case we must read the elements in the 33rd, 43rd, 53rd, 63rd, and 73rd positions. Since these positions are not contiguous, this must be done in 5 separate read operations. This operation is illustrated in figure 4: the solid lines again represent read operations, and the dotted lines represent seek operations. An alternative would be to perform a single large read operation, in this case 41 elements starting at the 33rd position. This is called a *sieve buffer* and is supported by HDF5 for contiguous datasets, but not for chunked datasets. By setting the chunk sizes correctly, it is possible to greatly exceed the performance of the sieve buffer scheme.

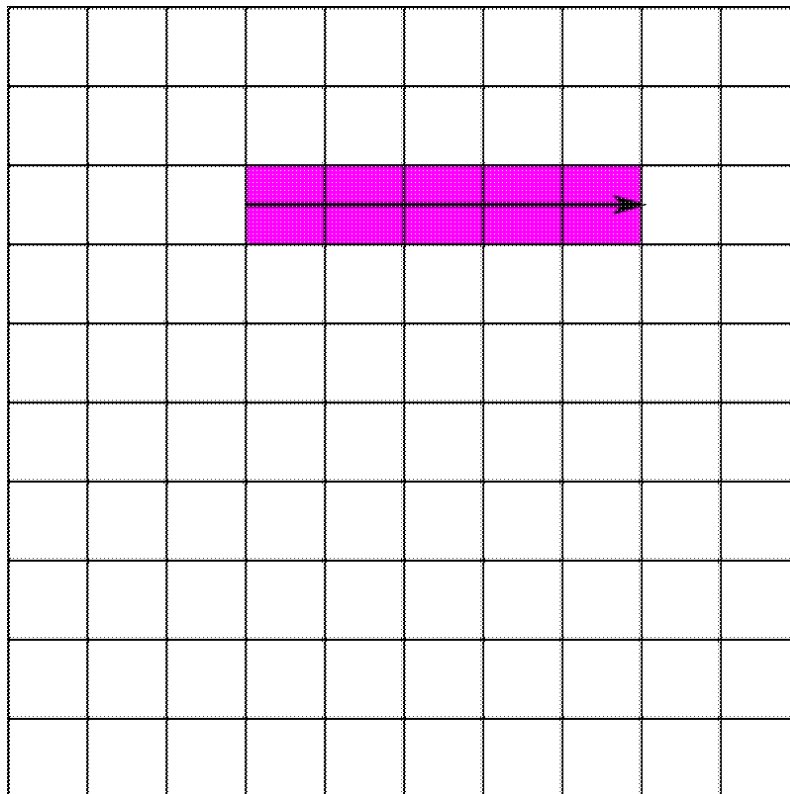

Figure 3. Reading part of a row from a contiguous dataset

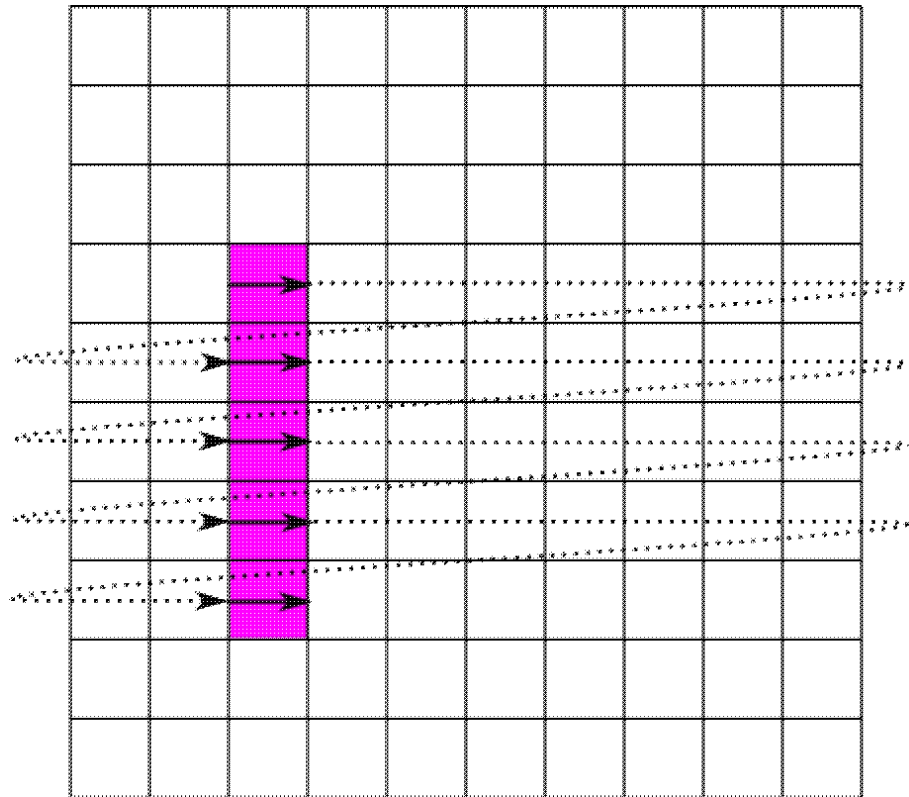

Figure 4. Reading part of a column from a contiguous dataset

Likewise, in higher dimensions, the last dimension specified is the fastest changing on disk. So if we have a four dimensional dataset A, then the first element on disk would be $A[0][0][0][0]$, the second $A[0][0][0][1]$, the third $A[0][0][0][2]$, and so on.

10.2.3. Chunking and Partial I/O

The issues outlined above regarding data storage order help to illustrate one of the major benefits of dataset chunking, its ability to improve the performance of partial I/O. Partial I/O is an I/O operation (read or write) which operates on only one part of the dataset. To maximize the performance of partial I/O, the data elements selected for I/O must be contiguous on disk. As we saw above, with a contiguous dataset, this means that the selection must always equal the extent in all but the slowest changing dimension, unless the selection in the slowest changing dimension is a single element. With a 2-d dataset in C, this means that the selection must be as wide as the entire dataset unless only a single row is selected. With a 3-d dataset, this means that the selection must be as wide and as deep as the entire dataset, unless only a single row is selected, in which case it must still be as deep as the entire dataset, unless only a single column is also selected.

Chunking allows the user to modify the conditions for maximum performance by changing the regions in the dataset which are contiguous. For example, reading a 20x20 selection in a contiguous dataset with a width greater than 20 would require 20 separate and non-contiguous read operations. If the same operation were performed on a dataset that was created with a chunk size of 20x20, the operation would require only a single read operation. In general, if your selections are always the same size (or multiples of the same size), and start at multiples of that size, then the chunk size should be set to the selection size, or an integer divisor of it. This recommendation is subject to the guidelines in the *pitfalls* section; specifically, it should not be too small or too large.

Using this strategy, we can greatly improve the performance of the operation shown in figure 4. If we create the dataset with a chunk size of 10×1 , each column of the dataset will be stored separately and contiguously. The read of a partial column can then be done in a single operation. This is illustrated in figure 5, and the code to implement a similar operation is shown in example 2. For simplicity, example 2 implements writing to this dataset instead of reading from it.

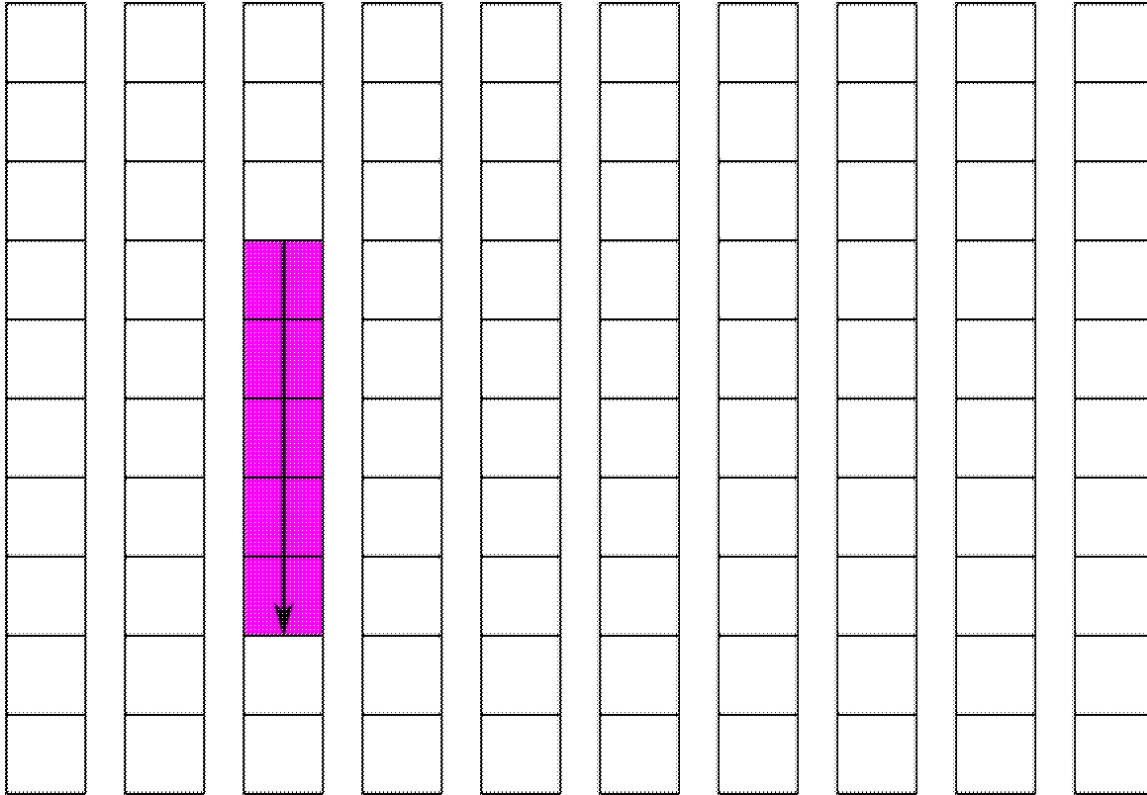

Figure 5. Reading part of a column from a chunked dataset

```

#include
int main(void) {
    hid_t          file_id, dset_id, fspace_id, mspace_id, dcpl_id;
    hsize_t chunk_dims[2] = {10, 1};
    hsize_t dset_dims[2] = {10, 10};
    hsize_t mem_dims[1] = {5};
    hsize_t start[2] = {3, 2};
    hsize_t count[2] = {5, 1};
    int          buffer[5];

    /* Create the file */
    file_id = H5Fcreate("file.h5", H5F_ACC_TRUNC, H5P_DEFAULT, H5P_DEFAULT);

    /* Create a dataset creation property list and set it to use chunking
     * with a chunk size of 10x1 */
    dcpl_id = H5Pcreate(H5P_DATASET_CREATE);
    H5Pset_chunk(dcpl_id, 2, chunk_dims);

    /* Create the dataspace and the chunked dataset */
    space_id = H5Screate_simple(2, dset_dims, NULL);
    dset_id = H5Dcreate(dataset, H5T_NATIVE_INT, space_id, dcpl_id,
H5P_DEFAULT);

    /* Select the elements from 3, 2 to 7, 2 */
    H5Sselect_hyperslab(fspace_id, H5S_SELECT_SET, start, NULL, count, NULL);

    /* Create the memory dataspace */
    mspace_id = H5Screate_simple(1, mem_dims, NULL);

    /* Write to the dataset */
    buffer =
H5Dwrite(dset_id, H5T_NATIVE_INT, mspace_id, fspace_id, H5P_DEFAULT, buffer);

    /* Close */
    H5Dclose(dset_id);
    H5Sclose(fspace_id);
    H5Sclose(mspace_id);
    H5Pclose(dcpl_id);
    H5Fclose(file_id);
    return 0;
}

```

Example 2. Writing part of a column to a chunked dataset

10.2.4. Chunk Caching

Another major feature of the dataset chunking scheme is the chunk cache. As it sounds, this is a cache of the chunks in the dataset. This cache can greatly improve performance whenever the same chunks are read from or written to multiple times, by preventing the library from having to read from and write to disk multiple times. However, the current implementation of the chunk cache does not adjust its parameters automatically, and therefore the parameters must be adjusted manually to achieve optimal performance. In some rare cases it may be best to completely disable the chunk caching scheme. Each open dataset has its own chunk cache, which is separate from the caches for all other open datasets.

When a selection is read from a chunked dataset, the chunks containing the selection are first read into the cache, and then the selected parts of those chunks are copied into the user's buffer. The cached chunks stay in the cache

until they are evicted, which typically occurs because more space is needed in the cache for new chunks, but they can also be evicted if hash values collide (more on this later). Once the chunk is evicted it is written to disk if necessary and freed from memory.

This process is illustrated in figures 6 and 7. In figure 6, the application requests a row of values, and the library responds by bringing the chunks containing that row into cache, and retrieving the values from cache. In figure 7, the application requests a different row that is covered by the same chunks, and the library retrieves the values directly from cache without touching the disk.

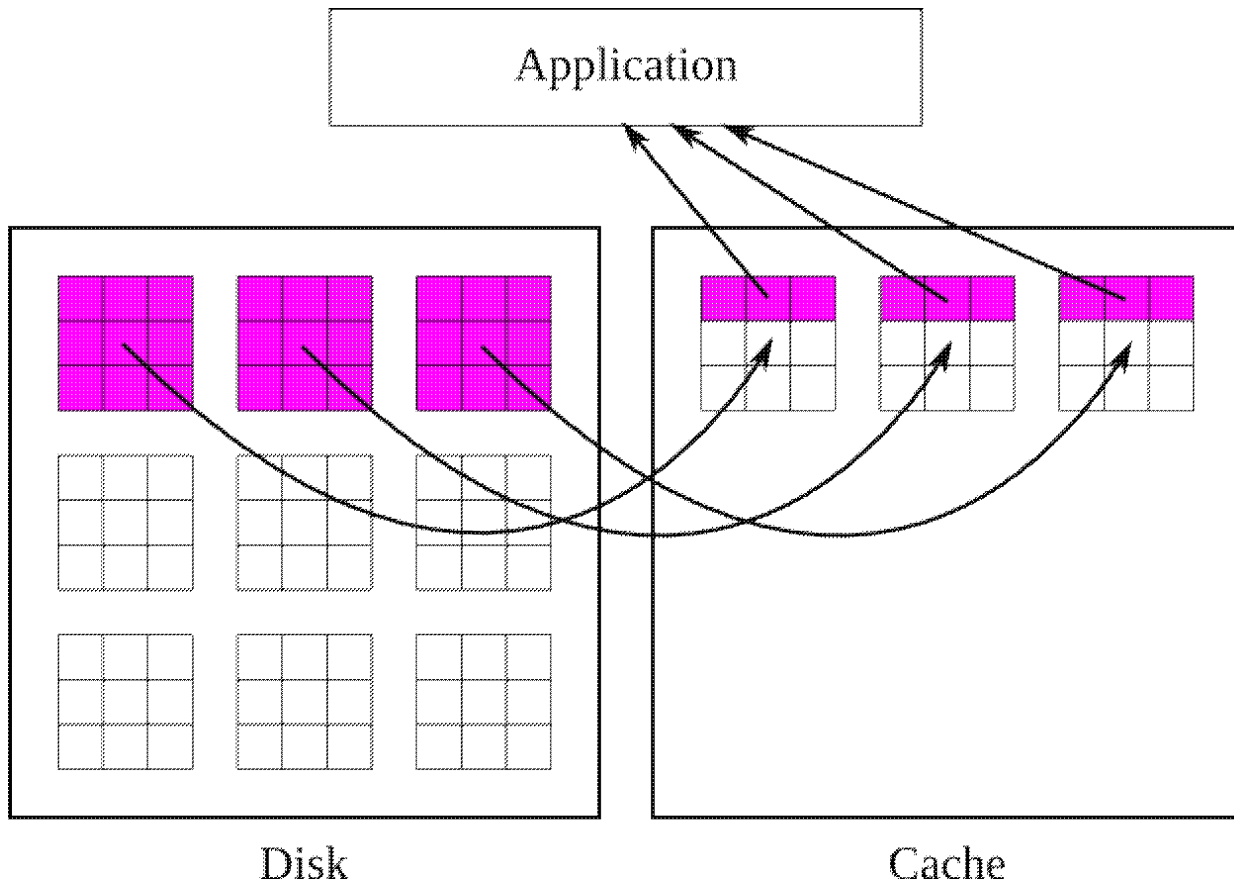

Figure 6. Reading a row from a chunked dataset with the chunk cache enabled

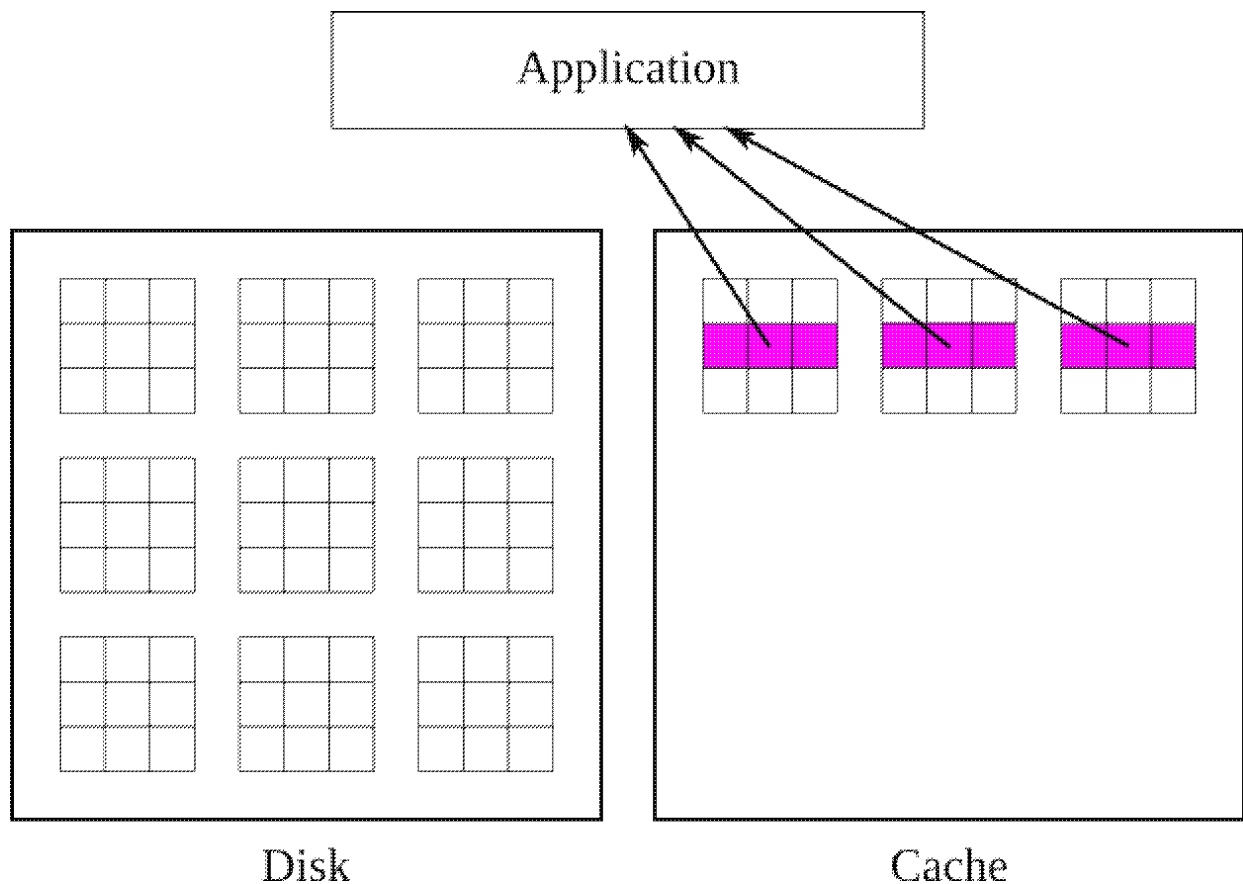

Figure 7. Reading a row from a chunked dataset with the chunks already cached

In order to allow the chunks to be looked up quickly in cache, each chunk is assigned a unique hash value that is used to look up the chunk. The cache contains a simple array of pointers to chunks, which is called a hash table. A chunk's hash value is simply the index into the hash table of the pointer to that chunk. While the pointer at this location might instead point to a different chunk or to nothing at all, no other locations in the hash table can contain a pointer to the chunk in question. Therefore, the library only has to check this one location in the hash table to tell if a chunk is in cache or not. This also means that if two or more chunks share the same hash value, then only one of those chunks can be in the cache at the same time. When a chunk is brought into cache and another chunk with the same hash value is already in cache, the second chunk must be evicted first. Therefore it is very important to make sure that the size of the hash table, also called the `nslots` parameter in `H5Pset_cache` and `H5Pset_chunk_cache`, is large enough to minimize the number of hash value collisions.

To determine the hash value for a chunk, the chunk is first assigned a unique index that is the linear index into a hypothetical array of the chunks. That is, the upper-left chunk has an index of 0, the one to the right of that has an index of 1, and so on. This index is then divided by the size of the hash table, `nslots`, and the remainder, or modulus, is the hash value. Because this scheme can result in regularly spaced indices being used frequently, it is important that `nslots` be a prime number to minimize the chance of collisions. In general, `nslots` should probably be set to a number approximately 100 times the number of chunks that can fit in `nbytes` bytes, unless memory is extremely limited. There is of course no advantage in setting `nslots` to a number larger than the total number of chunks in the dataset.

The `w0` parameter affects how the library decides which chunk to evict when it needs room in the cache. If `w0` is set to 0, then the library will always evict the least recently used chunk in cache. If `w0` is set to 1, the library will always evict the least recently used chunk which has been fully read or written, and if none have been fully read or written, it will evict the least recently used chunk. If `w0` is between 0 and 1, the behaviour will be a blend of the two. Therefore, if the application will access the same data more than once, `w0` should be set closer to 0, and if the application does not, `w0` should be set closer to 1.

It is important to remember that chunk caching will only give a benefit when reading or writing the same chunk more than once. If, for example, an application is reading an entire dataset, with only whole chunks selected for each operation, then chunk caching will not help performance, and it may be preferable to completely disable the chunk cache in order to save memory. It may also be advantageous to disable the chunk cache when writing small amounts to many different chunks, if memory is not large enough to hold all those chunks in cache at once.

10.2.5. I/O Filters and Compression

Dataset chunking also enables the use of I/O filters, including compression. The filters are applied to each chunk individually, and the entire chunk is processed at once. The filter must be applied every time the chunk is loaded into cache, and every time the chunk is flushed to disk. These facts all make choosing the proper settings for the chunk cache and chunk size even more critical for the performance of filtered datasets.

Because the entire chunk must be filtered every time disk I/O occurs, it is no longer a viable option to disable the chunk cache when writing small amounts of data to many different chunks. To achieve acceptable performance, it is critical to minimize the chance that a chunk will be flushed from cache before it is completely read or written. This can be done by increasing the size of the chunk cache, adjusting the size of the chunks, or adjusting I/O patterns.

10.2.6. Pitfalls

Inappropriate chunk size and cache settings can dramatically reduce performance. There are a number of ways this can happen. Some of the more common issues include:

- Chunks are too small

There is a certain amount of overhead associated with finding chunks. When chunks are made smaller, there are more of them in the dataset. When performing I/O on a dataset, if there are many chunks in the selection, it will take extra time to look up each chunk. In addition, since the chunks are stored independently, more chunks results in more I/O operations, further compounding the issue. The extra metadata needed to locate the chunks also causes the file size to increase as chunks are made smaller. Making chunks larger results in fewer chunk lookups, smaller file size, and fewer I/O operations in most cases.

- Chunks are too large

It may be tempting to simply set the chunk size to be the same as the dataset size in order to enable compression on a *contiguous* dataset. However, this can have unintended consequences. Because the entire chunk must be read from disk and decompressed before performing any operations, this will impose a great performance penalty when operating on a small subset of the dataset if the cache is not large enough to hold the one-chunk dataset. In addition, if the dataset is large enough, since the entire chunk must be held in memory while compressing and decompressing, the operation could cause the operating system to page memory to disk, slowing down the entire system.

- Cache is not big enough

Similarly, if the chunk cache is not set to a large enough size for the chunk size and access pattern, poor performance will result. In general, the chunk cache should be large enough to fit all of the chunks that contain part of a hyperslab selection used to read or write. When the chunk cache is not large enough, all of the chunks in the selection will be read into cache and then written to disk (if writing) and evicted. If the application then revisits the same chunks, they will have to be read and possibly written again, whereas if the cache were large enough they would only have to be read (and possibly written) once. However, if selections for I/O always coincide with chunk boundaries, this does not matter as much, as there is no wasted I/O and the application is unlikely to revisit the same chunks soon after.

If the total size of the chunks involved in a selection is too big to practically fit into memory, and neither the chunk nor the selection can be resized or reshaped, it may be better to disable the chunk cache. Whether this is better depends on the storage order of the selected elements. It will also make little difference if the dataset is filtered, as entire chunks must be brought into memory anyways in that case. When the chunk cache is disabled and there are no filters, all I/O is done directly to and from the disk. If the selection is mostly along the fastest changing dimension (i.e. rows), then the data will be more contiguous on disk, and direct I/O will be more efficient than reading entire chunks, and hence the cache should be disabled. If however the selection is mostly along the slowest changing dimension (columns), then the data will not be contiguous on disk, and direct I/O will involve a large number of small operations, and it will probably be more efficient to just operate on the entire chunk, therefore the cache should be set large enough to hold at least 1 chunk. To disable the chunk cache, either `nbytes` or `nslots` should be set to 0.

- Improper hash table size

Because only one chunk can be present in each slot of the hash table, it is possible for an improperly set hash table size (`nslots`) to severely impact performance. For example, if there are 100 columns of chunks in a dataset, and the hash table size is set to 100, then all the chunks in each row will have the same hash value. Attempting to access a row of elements will result in each chunk being brought into cache and then evicted to allow the next one to occupy its slot in the hash table, even if the chunk cache is large enough, in terms of `nbytes`, to hold all of them. Similar situations can arise when `nslots` is a factor or multiple of the number of rows of chunks, or equivalent situations in higher dimensions.

Luckily, because each slot in the hash table only occupies the size of the pointer for the system, usually 4 or 8 bytes, there is little reason to keep `nslots` small. Again, a general rule is that `nslots` should be set to a prime number at least 100 times the number of chunks that can fit in `nbytes`, or simply set to the number of chunks in the dataset.

10.2.7. For More Information

The “HDF5 Examples by API” page, <http://www.hdfgroup.org/ftp/HDF5/examples/examples-by-api/api18-c.html>, lists many code examples that are regularly tested with the HDF5 Library. Several illustrate the use of chunking in HDF5, particularly “Read/Write Chunked Dataset” and any examples demonstrating filters.

10.3. HDF5 Glossary and Terms

atomic datatype

A datatype which cannot be decomposed into smaller units at the API level.

attribute

A small dataset that can be used to describe the nature and/or the intended usage of the object it is attached to.

chunked layout

The storage layout of a chunked dataset.

chunking

A storage layout where a dataset is partitioned into fixed-size multi-dimensional chunks. Chunking tends to improve performance and facilitates dataset extensibility.

committed datatype

A datatype that is named and stored in a file so that it can be shared. Committed datatypes can be shared. Committing is permanent; a datatype cannot be changed after being committed. Committed datatypes used to be called named datatypes.

compound datatype

A collection of one or more atomic types or small arrays of such types. Similar to a struct in C or a common block in Fortran.

contiguous layout

The storage layout of a dataset that is not chunked, so that the entire data portion of the dataset is stored in a single contiguous block.

data transfer property list

The data transfer property list is used to control various aspects of the I/O, such as caching hints or collective I/O information.

dataset

A multi-dimensional array of data elements, together with supporting metadata.

dataset access property list

A property list containing information on how a dataset is to be accessed.

dataset creation property list

A property list containing information on how raw data is organized on disk and how the raw data is compressed.

dataspace

An object that describes the dimensionality of the data array. A dataspace is either a regular N-dimensional array of data points, called a simple dataspace, or a more general collection of data points organized in another manner, called a complex dataspace.

datatype

An object that describes the storage format of the individual data points of a data set. There are two categories of datatypes: atomic and compound datatypes. An atomic type is a type which cannot be decomposed into smaller units at the API level. A compound datatype is a collection of one or more atomic types or small arrays of such types.

enumeration datatype

A one-to-one mapping between a set of symbols and a set of integer values, and an order is imposed on the symbols by their integer values. The symbols are passed between the application and library as character strings and all the values for a particular enumeration datatype are of the same integer type, which is not necessarily a native type.

file

A container for storing grouped collections of multi-dimensional arrays containing scientific data.

file access mode

Determines whether an existing file will be overwritten, opened for read-only access, or opened for read/write access. All newly created files are opened for both reading and writing.

file access property list

File access property lists are used to control different methods of performing I/O on files.

file creation property list

The property list used to control file metadata.

group

A structure containing zero or more HDF5 objects, together with supporting metadata. The two primary HDF5 objects are datasets and groups.

hard link

A direct association between a name and the object where both exist in a single HDF5 address space.

hyperslab

A portion of a dataset. A hyperslab selection can be a logically contiguous collection of points in a dataspace or a regular pattern of points or blocks in a dataspace.

identifier

A unique entity provided by the HDF5 library and used to access an HDF5 object such as a file, group, or dataset. In the past, an identifier might have been called a handle.

link

An association between a name and the object in an HDF5 file group.

member

A group or dataset that is in another dataset, *dataset A*, is a member of *dataset A*.

name

A slash-separated list of components that uniquely identifies an element of an HDF5 file. A name begins that begins with a slash is an absolute name which is accessed beginning with the root group of the file; all other names are relative names and the associated objects are accessed beginning with the current or specified group.

opaque datatype

A mechanism for describing data which cannot be otherwise described by HDF5. The only properties associated with opaque types are a size in bytes and an ASCII tag.

path

The slash-separated list of components that forms the name uniquely identifying an element of an HDF5 file.

property list

A collection of name/value pairs that can be passed to other HDF5 functions to control features that are typically unimportant or whose default values are usually used.

root group

The group that is the entry point to the group graph in an HDF5 file. Every HDF5 file has exactly one root group.

selection

(1) A subset of a dataset or a dataspace, up to the entire dataset or dataspace. (2) The elements of an array or dataset that are marked for I/O.

serialization

The flattening of an N -dimensional data object into a 1-dimensional object so that, for example, the data object can be transmitted over the network as a 1-dimensional bitstream.

soft link

An indirect association between a name and an object in an HDF5 file group.

storage layout

The manner in which a dataset is stored, either contiguous or chunked, in the HDF5 file.

super block

A block of data containing the information required to portably access HDF5 files on multiple platforms, followed by information about the groups and datasets in the file. The super block contains information about the size of offsets, lengths of objects, the number of entries in group tables, and additional version information for the file.

variable-length datatype

A sequence of an existing datatype (atomic, variable-length (VL), or compound) which are not fixed in length from one dataset location to another.