

HDF Specification and Developer's Guide

Version 4.1r5 • November 2001

Copyright Notice and Statement for NCSA Hierarchical Data Format (HDF) Software Library and Utilities

Copyright 1988-2001 The Board of Trustees of the University of Illinois

All rights reserved.

Contributors: National Center for Supercomputing Applications (NCSA) at the University of Illinois, Fortner Research, Unidata Program Center (netCDF), The Independent JPEG Group (JPEG), Jean-loup Gailly and Mark Adler (gzip), and Digital Equipment Corporation (DEC).

Redistribution and use in source and binary forms, with or without modification, are permitted for any purpose (including commercial purposes) provided that the following conditions are met:

1. Redistributions of source code must retain the above copyright notice, this list of conditions, and the following disclaimer.
2. Redistributions in binary form must reproduce the above copyright notice, this list of conditions, and the following disclaimer in the documentation and/or materials provided with the distribution.
3. In addition, redistributions of modified forms of the source or binary code must carry prominent notices stating that the original code was changed and the date of the change.
4. All publications or advertising materials mentioning features or use of this software must acknowledge that it was developed by the National Center for Supercomputing Applications at the University of Illinois, and credit the Contributors.
5. Neither the name of the University nor the names of the Contributors may be used to endorse or promote products derived from this software without specific prior written permission from the University or the Contributors.

Disclaimer

THIS SOFTWARE IS PROVIDED BY THE UNIVERSITY AND THE CONTRIBUTORS "AS IS" WITH NO WARRANTY OF ANY KIND, EITHER EXPRESSED OR IMPLIED. In no event shall the University or the Contributors be liable for any damages suffered by the users arising out of the use of this software, even if advised of the possibility of such damage.

Trademarks

Sun is a registered trademark, and Sun Workstation, Sun/OS and Solaris are trademarks of Sun Microsystems Inc. / UNIX is a registered trademark of X/Open / VAX and VMS are trademarks of Digital Equipment Corporation / Macintosh is a trademark of Apple Computer, Inc. / CRAY and UNICOS are registered trademarks of Silicon Graphics, Inc. / IBM PC is a registered trademark of International Business Machines Corporation / MS-DOS is a registered trademark of Microsoft Corporation.

NCSA Contacts

Mail user feedback, bug reports, and questions to:

NCSA Scientific Data Technologies
HDF Group
152 Computing Applications Bldg.
605 E. Springfield Ave.
Champaign, IL 61820-5518

Send electronic correspondence and bug reports to the following:

hdfhelp@ncsa.uiuc.edu

Internet access

HDF is available without charge from NCSA's anonymous FTP server:

<ftp.ncsa.uiuc.edu/HDF/HDF/>

It is also accessible through the HDF Group's World Wide Web home page:

<http://hdf.ncsa.uiuc.edu/>

1

Introduction

1.1 Overview	1
1.2 Why HDF?	1
1.3 What is HDF?	2
1.4 Some History	4
1.5 About This Document	5
1.6 Document Contents	6
1.7 Conventions Used in This Document	7

2

Basic Structure of HDF Files

2.1 Chapter Overview	9
2.2 File Header	9
2.3 Data Objects	9
2.4 Physical Organization of HDF Files	12
2.5 Sample HDF File	13

3

Software Overview

3.1 Chapter Overview	15
3.2 HDF Software Layers	15
3.3 Software Organization	16
3.3.1 Versions and Release Numbers	16
3.3.2 ANSI C and Portability	17
3.3.3 Modules and Interfaces	17
3.3.4 Header Files	19
3.3.5 The HDF Test Suite	24
3.3.6 Sample HDF Programs	24
3.4 Some HDF Conventions	24

4

Low-level Interface

4.1 Chapter Overview	27
4.2 Introduction	27
4.3 New Low-level Routines with Version 3.2 and Higher	28
4.4 Overview of the Low-level Interface	29

5

Sets and Groups

5.1 Chapter Overview	37
5.2 Data Sets	37
5.2.1 Types of Sets	37
5.2.2 Calling Interfaces for Sets	38
5.3 Groups	38
5.3.1 General Features of Groups	39
5.4 Raster Image Sets (RIS)	40
5.4.1 Raster Image Groups (RIG)	40

5.4.2	RIS Tags	40
5.4.3	Raster Image Compression	42
5.5	Scientific Data Sets	42
5.5.1	Backward and Forward Compatibility	43
5.5.2	Internal Structures	43
5.5.3	SDG Structures	44
5.5.4	NDG Structures	45
5.5.5	SDG-like NDG Structures	46
5.5.6	Compatibility with Future NDG Structures	47
5.6	Vsets, Vdatas, and Vgroups	48
5.7	The Raster-8 Set (Obsolete)	49
5.7.1	Raster-8 Sets	49
5.7.2	Compatibility Between Raster-8 and Raster Image Sets	49
5.8	Deleted information from "Vsets, Vdatas, and Vgroups:"	50

6

Annotations

6.1	Chapter Overview	51
6.2	General Description	51
6.3	File Annotations	52
6.4	Object Annotations	52

7

Scientific Data Sets: The SD Model

7.1	Chapter Overview	55
7.2	UML Notation and Object Symbols in HDF Data Model Descriptions	55
7.3	Introduction to the SD Model	57
7.4	The SD User's Model	58
7.5	The SD Developer's Model	60
7.6	Mapping between SD Developer's Model and HDF File Structures	61
7.6.1	SD Collection	62
7.6.2	Attribute	62
7.6.3	Variable	63
7.6.4	Dimension	63
7.6.5	Overall Correspondence of SDS Elements and the HDF File Structure	64
7.6.6	Accessing SD Objects via non-SD Interfaces	65
7.7	SDS Memory Structures and Storage Layout	66
7.8	Library Implementation Details with Example File and SDS	68
7.8.1	Creating or opening an HDF file	68
7.8.2	Creating an empty SDS	68
7.8.3	Writing data to an SDS	71
7.8.4	Adding global and local attributes	72
7.8.5	Setting a data string	78
7.8.6	Setting a dimension name	78
7.8.7	Setting a dimension scale	80
7.8.8	Setting a dimension string	80
7.8.9	Terminating access to the SD collection and file	80

8

General Raster Images: The GR Model

8.1 Chapter Overview	81
8.2 Images in an HDF File	82
8.2.1 GR data sets	83
8.2.2 RIG images (RIS8 and RIS24)	84
8.2.3 RI8 images	84
8.3 The GR Data Model	85
8.3.1 A Casual View	85
8.3.2 The Formal GR Data Model	87
8.4 Mapping between GR Data Model and HDF File Structures	88
8.5 Modifying an RIG or RI8 Image via the GR Interface	90
8.6 Backwards Compatibility when Creating New Images via the GR Interface	91
8.7 Main Data Structures and their Relationships	92
8.7.1 File Information Structure (gr_info_t)	94
8.7.2 Raster Image Information Structure (ri_info_t)	94
8.7.3 Attribute Information Structure (at_info_t)	95
8.7.4 Dimension Information Structure (dim_info_t)	95
8.8 Relationships among Main Data Structures	95
8.9 The Evolution of an HDF File in the GR Interface	99
8.9.1 Creating or Opening an HDF File	99
8.9.2 Creating and Writing to a Raster Image	100
8.9.3 Adding Attributes	102
8.9.4 Adding Palettes	104
8.9.5 Opening an Existing File	104

9

Tag Specifications

9.1 Chapter Overview	107
9.2 The HDF Tag Space	107
9.3 Tag Specifications	107
9.3.1 Utility Tags	109
9.3.2 Annotation Tags	112
9.3.3 Compression Tags	115
9.3.4 Raster Image Tags	118
9.3.5 Composite Image Tags	125
9.3.6 Vector Image Tags	126
9.3.7 Scientific Data Set Tags	127
9.3.8 Vset Tags	135
9.3.9 Obsolete Tags	139

10

Extended Tags and Special Elements

10.1 Chapter Overview	143
10.2 Extended Tags and Alternate Physical Storage Methods	143
10.2.1 Extended Tag Implementation	143
10.3 Linked Block Elements	145
10.4 External Elements	146

10.5	Chunked Data Storage	147
10.5.1	Chunked Element Description Record	147
10.5.2	Chunk Table	149
10.6	Data Compression	150
10.6.1	Compression Header: The Common Elements of Compressed Element Description Records	150
10.6.2	Compressed Element Description Record: NBIT Run-length Encoding	152
10.6.3	Compressed Element Description Record: Skipping-Huffman	153
10.6.4	Compressed Element Description Record: GNU ZIP (Deflate)	153

11

Portability Issues

11.1	Chapter Overview	155
11.2	The HDF Environment	155
11.2.1	Supported Platforms	155
11.2.2	Language Standards	156
11.2.3	Guidelines	156
11.3	Organization of Source Files	156
11.3.1	Header Files	157
11.3.2	Source Code Files	157
11.3.3	File Naming Conventions	158
11.4	Passing Strings between FORTRAN and C	158
11.4.1	Passing Strings from FORTRAN to C	158
11.4.2	Passing Strings from C to FORTRAN	160
11.5	Function Return Values between FORTRAN and C	160
11.6	Differences in Routine Names	161
11.6.1	Case Sensitivity	161
11.6.2	Appended Underscores	162
11.6.3	Short Names vs. Long Names	163
11.7	Differences Between ANSI C and Old C	163
11.8	Type Differences	164
11.8.1	Size differences	164
11.8.2	Number Representation	165
11.8.3	Byte-order and Structure Representations	165
11.9	Access to Library Functions	166

Appendix A

Tags and Extended Tag Labels

A.10	Overview	167
A.11	Tags	167
A.12	Extended Tag Labels	170

Appendix B

Library Calling Trees

B.13	Overview	171
B.14	Library Calling Trees: SD API	171

Appendix C
Function Specifications

C.15 Overview 185
C.16 Opening and Closing Files 185
C.17 Locating Elements for Access and Getting Information 187
C.18 Reading and Writing Entire Data Elements 192
C.19 Reading and Writing Part of a Data Element 193
C.20 Manipulating Data Descriptors 195
C.21 Managing Special Data Elements 197
C.22 Data Set Chunking 200
C.23 Development Routines 208
C.24 Error Reporting 210
C.25 Other 212

Introduction

1.1 Overview

The Hierarchical Data Format (HDF) was designed to be an easy, straight-forward, and self-describing means of sharing scientific data among people, projects, and types of computers. An extensible header and carefully crafted internal layers provide a system that can grow as scientific data-handling needs evolve.

This document, the *NCSA HDF Specification and Developer's Guide*, fully describes the HDF data models, the corresponding file format specifications, and library implementation, and discusses criteria employed in the library's development. Where appropriate, this document provides limited guidelines for developers working on HDF itself or building applications that employ HDF.

This introduction provides a brief overview of HDF capabilities and design.

1.2 Why HDF?

A fundamental requirement of scientific data management is the ability to access as much information in as many ways, as quickly and easily as possible. A data storage and retrieval system that facilitates these capabilities must provide the following features:

Support for scientific data and metadata

Scientific data is characterized by a variety of data types and representations, data sets (including images) that can be extremely large and complex, and the need to attach accompanying attributes, parameters, notebooks, and other metadata. Metadata, supplementary data that describes the basic data (sometimes referred to as the raw data), includes information such as the dimensions of an array, the number type of the elements of a record, or a color lookup table (LUT).

Support for a range of hardware platforms

Data can originate on one machine only to be used later on many different machines. Scientists must be able to access data and metadata on as many hardware platforms as possible.

Support for a range of software tools

Scientists need a variety of software tools and utilities for easily searching, analyzing, archiving, and transporting the data and metadata. These tools range from a library of routines for reading and writing data and metadata, to small utilities that simply display an image on a console, to full-blown database retrieval systems that provide multiple views of thousands of sets of data and metadata.

Rapid data transfer

Both the size and the dispersion of scientific data sets require that mechanisms exist to get the data from place to place rapidly.

Extendibility

As new types of information are generated and new kinds of science are done, a means must be provided to support them.

1.3 What is HDF?

The HDF Structure

HDF is a self-describing extensible file format using tagged objects that have standard meanings. The idea is to store both a known format description and the data in the same file. HDF tags describe the format of the data because each tag is assigned a specific meaning; for example, the tag `DFTAG_LUT` indicates a color palette, the tag `DFTAG_RI` indicates an 8-bit raster image, and so on. A program that has been written to understand a certain set of tag types can scan the file for those tags and process the data. This program also can ignore any data that is beyond its scope.

Consider a data set representing a raster image in an HDF file as illustrated in Figure 1a below. The data set consists of three data objects with distinct tags representing the three types of data. The raster image object contains the basic data (or raw data) and is identified by the tag `DFTAG_RI`; the palette and dimension objects contain metadata and are identified by the tags `DFTAG_LUT` tags `DFTAG_ID`.

FIGURE 1a

Raster Image Set in an HDF File .

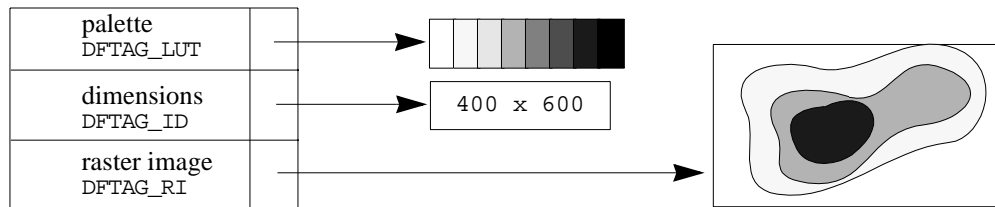

The set of available data objects encompasses both basic data and metadata. Most HDF objects are machine- and medium-independent, physical representations of data and metadata.

HDF Tags

The HDF design assumes that we cannot know *a priori* what types of data objects will be needed in the future, nor can we know how scientists will want to view that data. As science progresses, people will discover new types of information and new relationships among existing data. New types of data objects and new tags will be created to meet these expanding needs. To avoid unnecessary proliferation of tags and to ensure that all tags are available to potential users who need to share data, a portable public domain library is available that interprets all public tags. The library contains user interfaces designed to provide views of the data that are most natural for users. As we learn more about the way scientists need to view their data, we can add user interfaces that reflect data models consistent with those views.

Types of Data and Structures

HDF currently supports the most common types of data and metadata that scientists use, including multidimensional gridded data, 2-dimensional raster images, polygonal mesh data, multivariate data sets, finite-element data, non-Cartesian coordinate data, and text.

In the future there will almost certainly be a need to incorporate new types of data, such as voice and video, some of which might actually be stored on other media than the central file itself. Under such circumstances, it may become desirable to employ the concept of a virtual file. A *virtual file* functions like a regular file but does not fit our normal notion of a monolithic sequence of bits stored entirely on a single disk or tape.

HDF also makes it possible for the user to include annotations, titles, and specific descriptions of the data in the file. Thus, files can be archived with human-readable information about the data and its origins.

One collection of HDF tags supports a hierarchical grouping structure called a *Vgroup* that allows scientists to organize data objects within HDF files to fit their views of how the objects go together, much as a person in an office or laboratory organizes information in folders, drawers, journal boxes, and on their desktops.

Backward and Forward Compatibility

An important goal of HDF is to maximize backward and forward compatibility among its interfaces, and storage and object types. This is not always achievable, because data formats must sometimes change to enhance performance, to correct errors, or for other reasons. However, whenever possible, HDF files should not become out of date. For example, suppose a site falls far behind in the HDF standard so its users can only work with the portions of the specification that are three years old. Users at this site might produce files with their old HDF software then read them with newer software designed to work with more advanced data files. The newer software should still be able to read the old files.

Conversely, if the site receives files that contain objects that its HDF software does not understand, it should still be able to list the types of data in the file. It should also be able to access all of the older types of data objects that it understands, despite the fact that the older types of data objects are mixed in with new kinds of data. In addition, if the more advanced site uses the text annotation facilities of HDF effectively, the files will arrive with complete human-readable descriptions of how to decipher the new tag types.

Calling Interfaces

To present a convenient user interface made up of something more usable than a list of tag types with their associated data requirements, HDF supports multiple calling interfaces, utilities, and applications.

The low-level calling interface is used to manipulate tags and raw data, to perform error handling, and to control the physical storage of data. This interface is designed to be used by developers who are providing the higher level interfaces for applications like raster image storage or scientific data archiving. See Chapter 4, *Low-level Interface*, and in Chapter 3, *Software Overview*, see Section 3.3, "Software Organization."

The application interfaces, at the next level, include several modules specifically designed to simplify the process of storing and accessing specific types of data. For example, the palette interfaces are designed to handle color palettes and lookup tables, the general raster (GR) interface is designed to handle generalized raster images, and the scientific data (SD) interface is designed to handle arrays of scientific data. If you are primarily interested in reading data from or writing

data to HDF files, you will spend most of your time working with the application interfaces. See Section 3.3, "Software Organization," for a complete list of these APIs.

The HDF utilities and NCSA applications, at the top level, are special purpose programs designed to handle specific tasks or solve specific problems. The utilities provide a command line interface for data management. The applications provide solutions for problems in specific application areas and often include a graphic user interface. Several third party applications are also available at this level.

Machine Independence

An important issue in data file design is that of machine independence or transportability. The HDF design defines standard representations for storing all data types that it supports. When data is written to a file, it is typically written in the standard HDF representation. The conversion is handled by the HDF software and need not concern the user. Users may override this convention and install their own conversion routines, or they may write data to a file in the native format of the machine on which it was generated.

1.4 Some History

In 1987 a group of users and software developers at NCSA searched for a file format that would satisfy NCSA's data needs. There were some interesting candidates, but none that were in the public domain, were targeted to scientific data, and yet were sufficiently general and extensible. In the course of several months, borrowing concepts from several existing formats, the group designed HDF.

The first version of HDF was implemented in the spring and summer of 1988. It included a general purpose interface and an 8-bit raster image interface. In the fall of 1988, a scientific data set interface was designed and implemented, enabling HDF users to store multidimensional arrays and related data. Soon thereafter interfaces were implemented for storing color palettes, 24-bit raster images, and annotations.

In 1989, it became clear that there was a need to support a general grouping structure and unstructured data such as that used to represent polyhedra in graphical applications. This led to Vsets, whose interface routines were implemented as a separate HDF library.

Also in 1989 it became clear that the existing general purpose layer was not sufficiently powerful to meet anticipated future needs and that the coding could use a substantial overhaul. From this, the long process of redesigning the lower layers of HDF began. The first version incorporating extended tags and the new lower layers of HDF was released in the summer of 1992 as HDF Version 3.2.

In 1993, in response to the needs of flexibility in data ranges and sizes, HDF Version 3.3 was released. In this version of HDF, the new SD interface was introduced with multi-file access and an unlimited dimension feature for arrays. HDF Version 3.3 provided alternative physical storage methods (external and linked block data elements) through extended tags, JPEG data compression, changes to some Vset interface functions, access to netCDF files through a complete netCDF interface,¹ hyperslab access routines for old-style SDS objects, and various performance improvements.

1. NetCDF is a network-transparent derivative of the original CDF (Common Data Format) developed by the National Aeronautics and Space Administration (NASA). It is used widely in atmospheric sciences and other disciplines requiring very large data structures. NetCDF is in the public domain and was developed at the Unidata Program Center in Boulder, Colorado.

In 1994, as standard ANSI C became more commonly used, HDF shifted from K&R to ANSI C to support portability. After several beta versions, HDF Version 4.0 was released in 1996 and provided features such as support for n-bit integers and SDS compression, limited support for reading CDF files, a parallel I/O interface for the CM5, auto configuration, multi-file versions of the AN and GR interfaces, and significant improvement in I/O performance and memory usage. In addition, more options were added to existing HDF utilities and two new programs were added to the HDF utilities:

- **hdp**, to view the contents of HDF files
- **hdfunpac**, to unpack scientific datasets into external elements

HDF Version 4.1 was released in 1997. In this version, attributes were added to both the Vdata and Vgroup APIs to provide more ways for meaningfully storing data, data chunking was introduced in the SD API to improve I/O performance, and a new representation was used for storing dimensions to improve storage efficiency.

In 1998, the second release of HDF Version 4.1, called Version 4.1r2, was announced. In this release, data chunking was added for the GR API, the Java Products (the Java-based HDF Viewer, JHV, and the Java HDF interface, JHI) were incorporated into the HDF release itself, and the *HDF Reference Manual* and *HDF User's Guide* were extensively updated. In addition, the new representation of dimensions that was introduced in the previous release became the default representation.

HDF Version 4.1r3, released in May 1999, emphasized fixing problems in the SD and GR interfaces. The *HDF User's Guide* accompanying the release was significantly improved and updated. The term Vset became obsolete, being replaced with the more specific terms Vgroup and Vdata.

The current release, HDF Version 4.1r4, released in October 2000, completes the enabling of all GR chunking capabilities. In addition, new options were added to the **hdp** utility. This document, the *HDF Specification and Developer's Guide*, was largely rewritten for this release.

See the HDF website at <http://hdf.ncsa.uiuc.edu/> for release information, lists of supported platforms, and the list of bugs fixed in the current release.

The HDF library is considered mature and complete at this time. Future work will focus on technical support, maintenance, and bug fixes; there are no plans to implement new features. All new features and tools are being implemented in the HDF5 library, a new, next-generation product from the same team that built and supports HDF. HDF5 is discussed in detail on the web at <http://hdf.ncsa.uiuc.edu/HDF5/>.

1.5 About This Document

This document is designed for software developers who are designing applications or routines for use with HDF files and for users who need detailed information about HDF. Users who are interested in using HDF to store or manipulate their data will not normally need the kind of detail presented in this manual. They should instead consult one of the user-level documents:¹

Versions 4.x

NCSA HDF User's Guide

NCSA HDF Reference Manual

1. The user-level documents for Versions 3.2 and earlier were *NCSA HDF Calling Interfaces and Utilities* and *NCSA HDF Vset*; for Version 3.3, they were *Getting Started with NCSA HDF*, *NCSA HDF User's Guide*, and *NCSA HDF Reference Manual*. Library versions prior to Version 4.0 and the corresponding documents are no longer supported or available.

A tutorial is available online at the following URL:

<http://hdf.ncsa.uiuc.edu/training/HDFtraining/tutorial/index.html>

New material appears throughout this edition of *The HDF Specification and Developer's Guide*, but the following chapters bear special mention. Chapters 7 and 8 and Appendix B are entirely new. Chapter 10 contains new compression and chunking information and some material that previously appeared in Chapter 9.

Users of third-party software that uses HDF may also have to consult a manual for that software.

1.6 Document Contents

The *NCSA HDF Specification and Developer's Guide* contains the following chapters and appendix:

Chapter 1: Introduction

Introduces the document and provides an overview.

Chapter 2: Basic Structure of HDF Files

Introduces and describes the components and organization of HDF files.

Chapter 3: Software Overview

Describes the organization of the software layers that make up the basic HDF library and provides guidelines for writing HDF software.

Chapter 4: Low-level Interface

Describes the low-level HDF routines that make up the low-level interface (see also the H routines section of the *HDF Reference Manual*).

Chapter 5: Sets and Groups

Explains the roles of sets and groups in an HDF file, and describes raster image sets, scientific data sets, and Vgroups.

Chapter 6: Annotations

Explains the use of annotations in HDF files.

Chapter 7: Scientific Data Sets: The SD Model

Explains the role, structure, and usage of SDSs in HDF files.

Chapter 8: General Raster Images: The GR Model

Explains the role, structure, and usage of GRs in HDF files.

Chapter 9: Tag Specifications

Describes the tag identification space and the NCSA-supported basic tags.

Chapter 10: Extended Tags and Special Elements

Describes the extended tag structure and the NCSA-supported extended tags and special elements.

Chapter 11: Portability Issues

Describes the measures taken to maximize HDF portability across platforms and to ensure that HDF routines are available to both C and FORTRAN programs.

Appendix A: Tags and Extended Tag Labels

Presents a list of NCSA-supported HDF tags and a list of labels used with extended tags.

Appendix B: Library Calling Trees

Illustrates the calling structure of HDF library functions.

Appendix C: Function Specifications

Provides detailed specifications for selected low-level interface functions.

1.7 Conventions Used in This Document

Most of the descriptive text in this guide is printed in 10 point Times. Other typefaces have specific meanings that will help the reader understand the functionality being described.

New concepts and *newly defined terms* are sometimes presented in bold italics on their first occurrence to indicate that they are defined within the paragraph.

Cross references within the specification include the title of the referenced section in quotation marks or the reference chapter in italics. (E.g., See Section 3.3, "Software Organization," in Chapter 3, *Software Overview*, for a complete list of ...)

References to documents italicize the title of the document. (E.g., See the *HDF User's Guide* to familiarize yourself with the basic principles of using HDF.)

Literal expressions and *variables* often appear in the discussion. Literal expressions are presented in Courier while variables are presented in *italic Courier*. A literal expression is any expression that would be entered exactly as presented, e.g., commands, command options, literal strings, and data. A variable is an expression that serves as a place holder for some other text that would be entered. Consider the expression `cp file1 file2`. `cp` is a command name and would be entered exactly as it appears, so it is printed in Courier. But `file1` and `file2` are variables, place holders for the names of actual files, so they are printed in *italic Courier*; the user would enter the actual filenames.

This guide frequently offers sample *command lines*. Sometimes these are examples of what might be done; other times they are specific instructions to the user. Command lines may appear within running text, as in the preceding paragraph, or on a separate line, as follows:

```
cp file1 file2
```

Command lines always include one or more literal expressions and may include one or more variables, so they are printed in Courier and *italic Courier* as described above.

Keys that are labeled with more than one character, such as the RETURN key, are identified with all uppercase letters. Keys that are to be pressed simultaneously or in succession are linked with a hyphen. For example, "press CONTROL-A" means to press the CONTROL key then, without releasing the CONTROL key, press the A key. Similarly, "press CONTROL-SHIFT-A " means to press the CONTROL and SHIFT keys then, without releasing either of those, press the A key.

Table 1A summarizes the use of typefaces as used in examples and illustrations of HDF code and data, such as in literal strings and on sample command lines.

TABLE 1A

Meaning of Entry Format Notations

Type	Appearance	Example	Entry method
Literal expression (commands, literal strings, data)	Courier	do this	Enter the expression exactly as it appears.
Variables	<i>Italic Courier</i>	<i>filename</i>	Enter the name of the file or the specific data that this expression represents.
Special keys	Uppercase	RETURN	Press the key indicated.
Key combinations	Uppercase, with hyphens between key names	CONTROL-A	While holding down the first one or two keys, press the last key.

Program listings and **screen listings** are presented in `Courier` typeface, as in Figure 1a. When the listing is intended as a sample that the reader will use for an exercise or model, variables that the reader will change are printed in *italic Courier*.

FIGURE 1a

Sample screen listing

```

mars_53% ls -F
MinMaxer/                net.source
mars_54% cd MinMaxer
mars_55% ls -F
list.MinMaxer            minmaxer.v1.04/
mars_56% cd minmaxer.v1.04
mars_57% ls -F
COPYRIGHT                minmaxer.bin/          source.minmaxer/
README                   sample/                source.triangulation/
mars_58%
```

Basic Structure of HDF Files

2.1 Chapter Overview

This chapter introduces and describes the components and organization of Hierarchical Data Format (HDF) files. The components of an HDF file include a file header and a variety of data objects.

2.2 File Header

The first component of an HDF file is the *file header* (FH), which takes up the first four bytes in an HDF file. The file header is a signature that indicates that the file is an HDF file. Specifically, it is a 4-byte block with the hexadecimal value 0x0E 0x03 0x13 0x01.¹

To maintain HDF file portability, the characters must be read and written in the exact order shown.

2.3 Data Objects

The basic building block of an HDF file is the *data object*, which contains both data and information about the data. A data object has two parts: a 12-byte *data descriptor* (DD) and a *data element*. Figure 2a illustrates two data objects.

FIGURE 2a

Two Data Objects

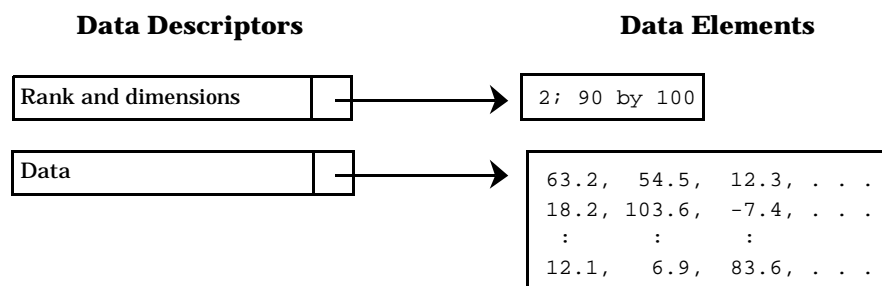

As the names imply, the data descriptor provides information about the data; the data element is the data itself. In other words, all data in an HDF file has information about itself attached to it. In this sense, HDF files are *self-describing* files.

1. 0x0E 0x03 0x13 0x01 is the hexadecimal representation of the characters control-N, control-C, control-S, and control-A, or ^N^C^S^A.

Data Descriptor (DD)

A data descriptor (DD) has four fields: a 16-bit tag, a 16-bit reference number, a 32-bit data offset, and a 32-bit data length. These are depicted in Figure 2b and are briefly described in Table 2a. Explanations of each part appear in the paragraphs following Table 2a.

FIGURE 2b

A Data Descriptor (DD)

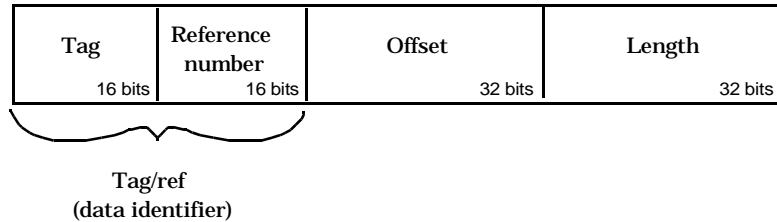

TABLE 2a

Parts of a Data Descriptor

Part	Description	
Tag/ref (data identifier)	Unique identifier for each data element	
	Tag	Type of data in a data element
	Reference number	Number distinguishing data element from others with the same tag
Offset	Byte offset of data element from beginning of file	
Length	Length of data element in bytes	

Tag/ref (Data Identifier)

A tag and its associated reference number, abbreviated as *tag/ref*, uniquely identify a data element in an HDF file. The tag/ref combination is also known as a *data identifier*.

Note: Only the full tag/ref uniquely identifies a data element.

Tag

A *tag* is the part of a data descriptor that tells what kind of data is contained in the corresponding data element. A tag is actually a 16-bit unsigned integer between 1 and 65535, but every tag is also given a name that programs can refer to instead of the number. If a DD has no corresponding data element, its tag is `DFTAG_NULL`, indicating that no data is present. A tag may never be zero.

Tags are assigned by NCSA as part of the specification of HDF. The following ranges are to be used to guide tag assignment:

00001 – 32767 Reserved for NCSA use

32768 – 64999 User-definable

65000 – 65535 Reserved for expansion of the format

Chapter 9, “*Tag Specifications*,” provides full specifications for all currently supported HDF tags. Appendix A, “*Tags and Extended Tag Labels*,” lists the current tag assignments. See Section 3.4, “Some HDF Conventions,” for more information on allocating tags.

Reference Number

Tags are not necessarily unique in an HDF file; there may be more than one data element of a given type. Therefore, the data descriptor includes a unique *reference number*.

Reference numbers are not necessarily assigned consecutively, so you cannot assume that the actual value of a reference number has any meaning beyond providing a means of distinguishing among elements with the same tag. Furthermore, reference numbers are only unique for data elements with the same tag; two 8-bit raster images will never have the same reference number but an 8-bit raster image and a 24-bit raster image might.

Reference numbers are 16-bit unsigned integers.

Data Offset and Length

The *data offset* states the byte position of the corresponding data element from the beginning of the file. The *length* states the number of bytes occupied by the data element.

Offset and length are both 32-bit signed integers. This results in a file-size limit of 2 gigabytes.

Note: All offsets are from the beginning of the file; they are not relative.

DD Blocks

Data descriptors are stored physically in a linked list of blocks called *data descriptor blocks* or DD blocks. The individual components of a DD block are depicted in Figure 2c. All of the DDs in a DD block are assumed to contain significant data unless they have the tag `DFTAG_NULL` (no data).

In addition to its DDs, each data descriptor block has a *data descriptor header* (DDH). The DDH has two fields: a *block size* field and a *next block* field. The block size field is a 16-bit unsigned integer that indicates the number of DDs in the DD block. The next block field is a 32-bit unsigned integer giving the offset of the next DD block, if there is one. The DDH of the last DD block in the list contains a 0 in its next block field.

FIGURE 2c

Model of a Data Descriptor Block

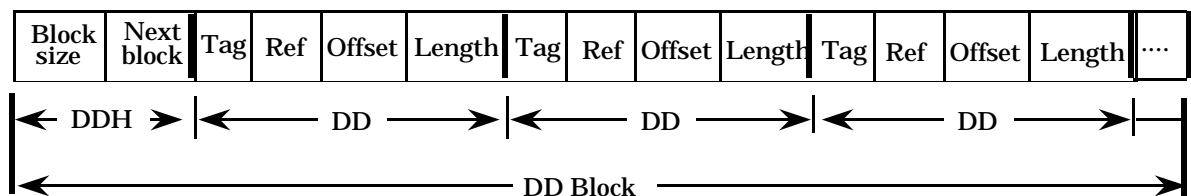

Since the default number of DDs in a DD block is defined when the HDF library is compiled, changing the default requires recompilation. (The default value, as distributed in the source code and pre-compiled binaries for Version 4.1r4, is 16.)

Data Element

A *data element* is the raw data portion of a data object. Its data type can be determined by examining its tag, but other interpretive information may be required before it can be processed properly.

Each data element is stored as a set of contiguous bytes starting at the offset and with the length specified in the corresponding DD. (See Figure 2d, "Physical Representation of Data Objects," on page 13.)¹

Exceptions and Special Cases

Note that there are a few exceptions and special cases to the above standards.

- The data object identified by the tag `DFTAG_MT`, for machine type, consists of the tag immediately followed by four number types. Since there can be only one `DFTAG_MT` tag in an HDF file and the data can be stored in the DD with the tag, there is no need for a data element. Consequently, the reference number, offset, and length are unnecessary.
- Several tags, specifically `DFTAG_NULL`, `DFTAG_JPEG`, and `DFTAG_GREYJPEG`, serve as binary flags and convey all the required information by the mere fact of their presence in an HDF file. These tags therefore point to no data element and have offset and length values of 0. `DFTAG_NULL` indicates a data object containing no data. `DFTAG_JPEG` and `DFTAG_GREYJPEG` indicate that an associated data object, indicated by a different tag but the same reference number, contains JPEG data image. The descriptions of these tags include a *sink pointer* () in the diagrams in Chapter 9.
- It is possible to create a tag/ref object then to end access to that object before writing any data or specifying its size. In such cases, the offset and length in the DD block will be set to the *invalid offset* or *invalid length* value of `0xFFFFFFFF`.

See the related entries in Chapter 9, *Tag Specifications*, for complete descriptions of these tags.

2.4 Physical Organization of HDF Files

The file header, DD blocks, and data elements appear in the following order in an HDF file:

- File header
- First DD block
- Data elements
- More DD blocks, more data elements, etc., as necessary

These relationships are summarized in Table 2b.

The only rule governing the distribution of DD blocks and data elements within a file is that the first DD block must follow immediately after the file header. After that, the pointers in the DD headers connect the DD blocks in a linked list and the offsets in the individual DDs connect the DDs to the data elements.

TABLE 2b

Summary of the Relationships among Parts of an HDF File

Part	Constituents
HDF file	FH, DD block, data, DD block, data, DD block, data...
FH	0x0e031301 [32-bit HDF magic number]
DD block	DDH, DD, DD, DD, ...
DDH	Number of DDs [16 bits], offset to next DD block [32 bits]
DD	Tag [16 bits], ref [16 bits], offset [32 bits], length [32 bits]
Data	Data element, data element, data element ...

FH = file header, DD = data descriptor, DDH = DD header

1. Some HDF software provides the capability of storing objects as a series of linked blocks or external elements, but this occurs at a higher level. At the lowest level, each object with a tag/ref is stored contiguously.

2.5 Sample HDF File

We are now ready to examine a sample file. Consider an HDF file that contains two 400-by-600 8-bit raster images as described in Table 2c.

TABLE 2c

Sample Data Objects in an HDF File

Tag	Ref	Data
DFTAG_FID	1	File identifier: user-assigned title for file
DFTAG_FD	1	File descriptor: user-assigned block of text describing overall file contents
DFTAG_LUT	1	Image palette (768 bytes)
DFTAG_ID	1	x - and y -dimensions of the 2-dimensional arrays that contain the raster images (4 bytes)
DFTAG_RI	1	First 2-dimensional array of raster image pixel data ($x*y$ bytes)
DFTAG_RI	2	Second 2-dimensional array of pixel data (also $x*y$ bytes)

Assuming that a DD block contains 10 DDs, the physical organization of the file could be described by Figure 2d.

In this instance, the file contains two raster images. The images have the same dimensions and are to be used with the same palette, so the same data objects for the palette (DFTAG_IP8) and dimension record (DFTAG_ID8) can be used with both images.

FIGURE 2d

Physical Representation of Data Objects

Section	Item	Offset	Contents
Header	FH	0	0e031301 (<i>HDF magic number; in hexadecimal</i>)
DD block	DDH	4	10 0
	DD	10	DFTAG_FID 1 130 4
	DD	22	DFTAG_FD 1 134 41
	DD	34	DFTAG_LUT 1 175 768
	DD	46	DFTAG_ID 1 943 4
	DD	58	DFTAG_RI 1 947 240000
	DD	70	DFTAG_RI 2 240947 240000
	DD	82	DFTAG_NULL (<i>Empty</i>)
	DD	94	DFTAG_NULL (<i>Empty</i>)
	DD	106	DFTAG_NULL (<i>Empty</i>)
Data	Data	130	sw3
	Data	134	solar wind simulation: third try. 8/8/88
	Data	175 (<i>Data for the image palette</i>)
	Data	943	400 600 (<i>Image dimensions</i>)
	Data	947 (<i>Data for the first raster image</i>)
	Data	240947 (<i>Data for the second raster image</i>)

Software Overview

3.1 Chapter Overview

This chapter describes the HDF software organization and provides guidelines for writing HDF software.

HDF is an amalgam of code and functionality from many sources. For example, the netCDF code came from the Unidata Program Center, and data compression and conversion software has been acquired from a variety of third parties. NCSA staff wrote the code for the basic HDF functionality and performed all of the integration work.

This document contains specifications for the NCSA-developed code and functionality. It does not include specifications for code or functionality from non-NCSA sources, though it does sometimes refer to specifications provided by other sources. Only the HDF interface to such code is specified in this document.

3.2 HDF Software Layers

There are three basic levels of HDF software:

- HDF low-level interface
- HDF application interfaces
- HDF applications and utilities

The lowest layer, the *low-level interface*, includes general purpose routines that form the basis of all higher-level HDF development. The low-level interface directly executes operations such as file I/O, error handling, memory management, and physical storage.

The *application interfaces* support higher level views of data and provide the interfaces for building user-level applications. Routines that handle raster images, palettes, annotations, scientific data sets, vdatas, vgroups, and netCDF appear at this level.

The *applications and utilities* are implemented at the highest level. NCSA utilities, NCSA applications, and third party applications are all implemented at this level.

The utilities perform general functions, such as listing the contents of an HDF file, and more specialized functions, such as converting data from one HDF data type to another (e.g., raster images to scientific data sets). In general, the utilities have simple command line interfaces and perform data management tasks.

The applications usually perform data analysis tasks and have polished interactive user interfaces. They include the NCSA Visualization Tool Suite, commercial software packages that use HDF, and other packages created at NCSA and by various third party projects.

Figure 3a illustrates this layered implementation.

FIGURE 3a

HDF Software Layers ¹

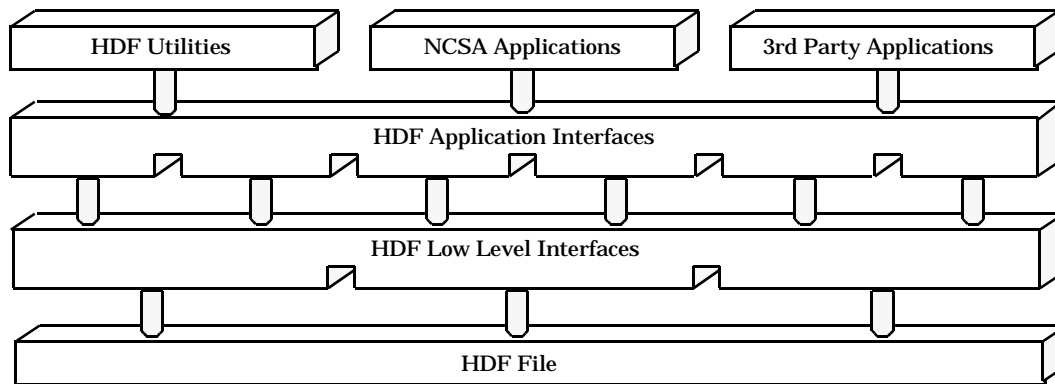

The low-level interface is described in detail in this document. The application interfaces and command line utilities are described in the document *NCSA HDF Calling Interfaces and Utilities* for Versions 3.2 and earlier and in the *HDF User's Guide* and *HDF Reference Manual* for Versions 3.3 and 4.x. Other HDF-based software tools should have their own manuals.

Since the NCSA user community writes programs primarily in C and FORTRAN, all of the HDF application interfaces developed at NCSA are callable from both C and FORTRAN programs. The functions of the low-level interface, however, are provided only as C-callable routines.

3.3 Software Organization

3.3.1 Versions and Release Numbers

Since HDF is under continual development, new releases are periodically made available. Releases are identified with a version number consisting of three elements:

- < *majorv* > Major version number, integer
- < *minorv* > Minor version number, integer
- < *rn* > Release number, integer

The version number is presented in the following format:

< *majorv* > . < *minorv* > r < *rn* > (e.g., Version 3.2r1)

These elements are interpreted as follows:

Major version number

A new major version number is assigned when there is some fundamental difference between a new version of the library and the previous version. When a new major version is released, HDF users and developers are strongly encouraged to obtain the new source code and documentation. There will probably be added functionality in succes-

1. This is a simplified illustration of the HDF software layers. Though the basic principles illustrated here continue to apply, the introduction of netCDF and multiple-file HDF data structures renders the implementation considerably more complex.

sive major versions of the library and some obsolete code may be deleted. Some user code may have to be modified to use the new library.

Minor version number

A new minor version number indicates an intermediate release between one major version and the next. Changes will probably be significant. When a new minor version is released, users and developers are strongly encouraged to obtain the new source code and documentation. There may be minor interface changes.

Release number

A new release number is assigned when bug fixes or other small modifications have been made. Using a new release of the same version of the library will not usually require modifying existing user code.

3.3.2 ANSI C and Portability

To ensure that HDF can be easily ported to new platforms, all versions of the HDF source code from Version 3.2 on are written in ANSI standard C, with special provisions for non-ANSI compilers. For more information about porting HDF and writing portable HDF-based code, refer to Chapter 11, *Portability Issues*.

3.3.3 Modules and Interfaces

The HDF distribution contains many source files or modules that can be grouped into families. For example, `dfp.c`, `dfpf.c`, and `dfpff.f` all share the root name `dfp` and, therefore, all belong to the `dfp` family. In general, each family of source modules represents one HDF applications interface; the `dfp` family represents the HDF Palette Interface (DFP).

For each interface, there is necessarily one file that contains the C code that provides the basic functionality of that interface. Some interfaces may have one or two additional code modules that provide FORTRAN callability for the interface, so a family may have one, two, or three files:

- 1 file Modules of this sort are generally not calling interfaces themselves; they provide useful support functions for actual calling interfaces. Since they are not meant to be called by any routine outside the HDF library, they do not need to be FORTRAN-callable. Example: `hblocks.c` is called only by internal HDF routines and has only the C-callable interface.
- 2 files Some interfaces need only one extra source module to provide FORTRAN compatibility. In such cases, there are only two source modules for the interface. Example: `mfan.c` and `mfanf.c` make up the Multifile Annotation Interface.
- 3 files Most current implementations of FORTRAN-callable HDF interfaces require that character string arguments be passed to some of their functions. Due to differences in the way C and FORTRAN represent strings, passing strings requires that there be a small amount of special purpose FORTRAN code written for each function that takes a string argument.

Therefore, most FORTRAN-callable HDF interfaces consist of three source modules:

- The primary C module
- A FORTRAN-callable C module
- A FORTRAN module

Example: `dfsd.c`, `dfsdf.c`, and `dfsdff.f` make up the Single-file Scientific Data Interface. `dfsd.c` contains the basic functionality of the interface. `dfsdf.c` provides the major part of FORTRAN callability. And `dfsdff.f` contains the special purpose FORTRAN code that enables passing character string arguments.

Table 3a, "HDF Version 4.x Source Code Modules," on page 20 lists the families of source code modules and header files of HDF Version 4.x. The first column of the table lists the name of the interface or the category of the modules, depending on their functionality. The modules are categorized as follows:

- **Low-level interface, or H-level interface**, includes modules that facilitate portability and provide physical storage management, error handling mechanisms, support for simultaneous access to multiple objects within a single file, support for simultaneous access to multiple files, and an interface for key lower-level modules. Low-level routines begin with an `H` (e.g., `Hopen/Hclose` or `Hread/Hwrite`).
- **Multifile Scientific Data interface (SD API)** includes modules that provide the mechanisms for managing scientific data sets in a multifile environment. These modules reside in the directory `mfhdf/`, which is separate from that of the other interfaces. Library routines in this interface begin with `SD`. This interface replaces the Single-file Scientific Data interface (DFSD API). (A substantial number of local or internal routine names in this code are influenced by `netCDF`.)
- **Vdata interface (VS API)** includes modules that provide mechanisms for managing `Vdata`s. Library routines in this interface begin with `vs`.
- **Vgroup interface (V API)** includes modules that provide mechanisms for managing `Vgroups`. Library routines in this interface begin with a `v`. Note that in the Content Description column, the `V` and `VS` routines share some modules and header files.
- **Multifile Annotation interface (AN API)** includes modules that provide mechanisms for managing annotations in a multifile environment. Library routines in this interface begin with `AN`. This interface replaces the Single-file Annotation interface (DFAN API).
- **General Raster Image interface (GR API)** includes modules that provide mechanisms for managing general raster images in a multifile environment. Library routines in this interface begin with `GR`. This interface replaces the 8-bit Raster Image interface (DFR8 API) and the 24-bit Raster Image interface (DFR24 API), which operate in the single-file environment.
- **Palette interface (DFP API)** includes modules that provide mechanisms for managing the palettes that are used by the raster image interfaces. Library routines in this interface begin with `DFP`.
- **Compression/Decompression** includes modules that provide mechanisms for managing file and image compression and decompression.
- **Conversion** includes modules that provide mechanisms to support conversion to and from the HDF format.
- **Single-file Scientific Data interface (DFSD API)** includes modules that provide mechanisms for managing scientific data sets in a single-file environment. Library routines in this interface begin with `DFSD`. This interface is replaced by the Multifile SD interface (SD API).
- **Single-file General Raster Image interface (DFGR API)** includes modules that provide mechanisms for managing general raster images in the single-file environment. This interface is an older version of the GR interface.
- **8-bit Raster Image interface (DFR8 API)** includes modules that provide mechanisms for managing 8-bit raster images. This interface is replaced by the Multifile GR interface.

- **24-bit Raster Image interface (DFR24 API)** includes modules that provide mechanisms for managing 24-bit raster images. This interface is replaced by the Multifile GR interface.
- **Single-file Annotation interface (DFAN API)** includes modules that provide mechanisms for managing annotations in the single-file environment. This interface is replaced by the Multifile AN interface.
- **Developer-level interface** includes modules that are at a lower level than the H-level modules, which heavily use the developer-level routines. These modules simplify the task of writing HDF applications by providing low-level routines for internal I/O handling, dynamic storage handling, memory management, and data descriptor handling.
- **Mac Only interface** includes modules that implement UNIX-like directory reading for the Macintosh.

The second column of Table 3a divides the modules in the interface into three groups: header files, C modules, and FORTRAN interface and support. The header files are discussed in the next section. The C modules group contains the primary C modules. The FORTRAN interface and support group contains either or both the FORTRAN-callable C module and the FORTRAN module of the interface.

3.3.4 Header Files

In addition to the source code modules discussed above, some interfaces also have C header files associated with them that are meant to be included by C applications programmers with the `#include` preprocessor directive. They contain useful constants and data structures for interaction with the interface from C programs. The header files can be identified by the same name as the root name for the rest of the family with the `.h` extension. For example, `dfsd.h` is the header file for the Single-file Scientific Data Interface.

Of particular importance among the C header files are `mfhdf.h`, `hdf.h` and `hdfi.h`:

- `mfhdf.h` Contains symbolic constants and public data structures for HDF's SD interface. `mfhdf.h` must be included by any program that uses the SD API of the HDF library.
- `hdf.h` Contains all the symbolic constants and public data structures required by HDF. `hdf.h` must be included by any program that uses the HDF library. (Note that this file is automatically included by the inclusion of `mfhdf.h` and need not be included separately.)
- `hdfi.h` Contains specific portability information about each platform on which HDF is supported. `hdfi.h` is automatically included in a program when `hdf.h` is included, so programmers need not explicitly include it.

Refer to Chapter 11, *Portability Issues*, for more information on `hdfi.h` and other portability issues. Refer to Table 3a for the listing of the header files provided in the current version of the HDF library.

TABLE 3a

HDF Version 4.x Source Code Modules

Category	Module type	Module name	Content Description
H-level	Header files	hchunks.h hdf.h hdfi.h herr.h hfile.h hkit.h hlimits.h hntdefs.h hproto.h htags.h patchlevel.h	Definitions for chunked elements HDF user-level definitions, for applications using HDF routines Definitions for portability Definitions for HDF error handling/reporting routines Definitions for HDF low-level file I/O routines Definitions for string mapping routines Defined limits for the library, reserved Vdata/Vgroup names and classes, and pre-attribute names. Definitions for most of the constants in the library. Number-type definitions for HDF Useful macros, potential for future functions HDF tag definitions Definition of PATCHLEVEL
	C modules	hblocks.c hchunks.c herr.c hextelt.c hfile.c hkit.c	Routines to implement linked-block elements Routines to implement chunked elements Routines for error handling/reporting Routines for external elements Low-level file I/O routines Various string mapping routines
	FORTRAN interface and support	herrf.c	C stubs for FORTRAN error handling/reporting routines
Multifile Scientific Data (SD API)	Header files	alloc.h error.h hdf2netcdf.h local_nc.h mf hdf.h win32cdf.h	Definitions for memory management Prototypes for error handling routines HDF names of netCDF API functions Definitions of structures for CDF and its components Definitions for applications using SD routines Definitions used for the Windows version of the library
	C modules	array.c attr.c cdf.c dim.c error.c file.c globdef.c hdfsds.c iarray.c mfsd.c nssdc.c putget.c putgetg.c sharray.c string.c var.c xdrposix.c xdrstdio.c	Routines that operate the structure NC_array Routines that operate the structure NC_attr Routines that operate the CDF structure NC its components Routines that operate NC_dim and locally related routines Utility routines to implement consistent error logging mechanisms for netCDF Low-level "nc" routines and other routines that operate the structures NC and XDR Initialization of global variables that allow the creation of SunOS sharable libraries Routines that read old SDS objects out of HDF files Routines that operate NC_iarray SD and SDI library routines that are local to this module Routines that read CDF V2.x files created with the CDF library Routines that read/write SD objects at the Vgroup and Vdata level Routines that perform I/O on a generalized hyperslab Internal routines for short integers Routines that operate NC_string Routines that operate NC_var and locally related routines Routines that implement XDR on a POSIX file descriptor Routines that implement XDR on a stdio stream
	FORTRAN interface and support	mfsdf.c mfsdff.f	C stubs for SD library routines FORTRAN stubs for SD library routines

Category	Module type	Module name	Content Description
Vdata (VS API)	Header files	vattr.h	definitions for vgroup/vdata attribute interface
	C modules	vattr.c vg.c vhi.c vio.c vrw.c vsfld.c	V and VS library routines that handle Vgroup/Vdata attributes Mostly Vdata library routines, but also some Vgroups routines VH library routines for vdata high-level access VS library routines that handle vdatas and locally used routines VS library routines that read and write vdatas VF and VS library routines that handle vdata fields
	FORTRAN interface and support	vattrf.c vattrff.f vgf.c vgff.f	C stubs for handling vgroup/vdata attributes FORTRAN stubs for handling vgroup/vdata attributes C stubs for vgroups and vdatas library routines FORTRAN stubs for vgroups and vdatas library routines
Vgroup (V API)	Header files	dfgroup.h vg.h vgint.h	Definitions for dfgroup.c Defined symbols and structures used in all v*.c files Private defined symbols and structures used in all v*.c files
	C modules	vconv.c vgp.c vparse.c	Routines that handle Vgroup/Vdata compatibility and conversion V library routines that handle Vgroups and locally used routines Routines for parsing
	FORTRAN interface and support		listed in Vdata API
Multifile Annotation (AN API)	Header files	mfan.h	Definitions for multifile annotations
	C modules	mfan.c	AN library routines that read and write multifile annotations
	FORTRAN interface and support	mfanf.c	C stubs for handling multifile annotations
Multifile General Raster Image (GR API)	Header files	mfgr.h	Definitions for multifile general raster images
	C modules	mfgr.c	GR library routines that access multifile general raster images
	FORTRAN interface and support	mfgrf.c mfgrff.f	C stubs for accessing multifile general raster images FORTRAN stubs for accessing multifile general raster images
Palette (DFP API)	Header files		This interface uses only the header file hdf.h
	C modules	dfp.c	DFP routines that read and write palettes
	FORTRAN interface and support	dfpf.c dfpff.f	C stubs for palette routines FORTRAN stubs for palette routines
Compression/Decompression	Header files	cnbit.h crle.h hcomp.h hcomp.h	Definitions for N-bit encoding Definitions for run-length encoding Definitions for compression information and structures Internal library header file for compression information
	C modules	crle.c dfcomp.c dfjpeg.c dfrle.c dfunjpeg.c hcomp.c hcompri.c	Internal I/O routines for HDF run-length encoding Routines that perform file compression Routines that perform JPEG image compression Routines that perform RLE image compression Routines that perform JPEG image decompression I/O routines for compressed data Routines for reading and writing old-style compressed raster images, such as JPEG, (raster specific) RLE, and IMCOMP
	FORTRAN interface and support	none	

Category	Module type	Module name	Content Description
Conversion	Header files	dfconvrt.h dfufp2i.h hconv.h	The macro DFconvert to speed up the conversion process Definitions for dfufp2i.c Definitions for data conversion
	C modules	dfconv.c dfkconv.c dfkcray.c dfkfuji.c dfknat.c dfkswap.c dfkvms.c dfufp2i.c	Routines that support conversion to and from HDF format Routines to support Convex-native conversion to/from HDF format Routines to support Cray conversion to/from HDF format Routines to support Fujitsu-native (VP) conversion to/from HDF format Routines to support native-mode conversion to/from HDF format Routines to support little-endian conversion to/from HDF format Routines to support Vax-native conversion to/from HDF format Utility functions to convert floating point data to 8-bit raster image set (RIS8) format
	FORTRAN interface and support	none	
Single-file Scientific Data (DFSD API)	Header files	dfsd.h	Definitions for single-file scientific data
	C modules	dfsd.c	DFSD routines that read and write Scientific Data Sets
	FORTRAN interface and support	dfsd.f.c dfsdff.f	C stubs for single-file scientific data routines FORTRAN stubs for single-file Scientific Data routines
Single-file General Rasters (DFGR API)	Header files	dfgr.h	Definitions for single-file general and 24-bit raster images
	C modules	dfgr.c dfimcomp.c	DFGR routines that read and write general raster images (old) Routines that perform color image compression
	FORTRAN interface and support	none	
8-bit Raster Images (DFR8 API)	Header files	dfr8.h	Definitions for 8-bit raster image groups
	C modules	dfr8.c	DFR8 routines that read and write 8-bit raster image groups
	FORTRAN interface and support	dfr8f.c dfr8ff.f	C stubs for 8-bit raster image group routines FORTRAN stubs for 8-bit raster image group routines
24-bit Raster Images (DFR24 API)	Header files		This interface uses dfgr.h in the single-file General Raster interface
	C modules	df24.c	Routines that read and write 24-bit raster images
	FORTRAN interface and support	df24f.c df24ff.f	C stubs for 24-bit raster image routines FORTRAN stubs for 24-bit raster image routines
Single-file Annotations (DFAN API)	Header files	dfan.h	Definitions for single-file annotations
	C modules	dfan.c	Routines that read and write single-file annotations
	FORTRAN interface and support	dfanf.c dfanff.f	C stubs for annotation routines FORTRAN stubs for annotation routines

Category	Module type	Module name	Content Description
Developer-level	Header files	atom.h bitvect.h cdeflate.h cnbit.h cnone.h cskphuff.h df.h dfi.h dfivms.h dfstubs.h dfutil.h dgroup.h dynarray.h glist.h hbitio.h hqueue.h linklist.h maldebug.h mcache.h mstdio.h tbbt.h	Definitions for atom code Definitions for bit vector code Definitions for deflate encoding Definitions for N-bit encoding Definitions for none-encoding Definitions for Skipping Huffman encoding Definitions for data descriptors HDF internal header file HDF internal header file for VMS Definitions for dfstubs.c HDF 3.1 emulation using new routines from hfile.c Definitions for low-level utility routines Definitions for low-level implementation of groups Definitions for dynamic storage handling Definitions for general list Data structures and macros for bitfile access to HDF data objects; mainly used for compression I/O and N-bit data objects Modified version of Berkley code for manipulating memory pool Definition for generic linked lists Definitions for dynamic memory handling Modified version of Berkley code for manipulating memory pool Definitions for stdio-like routines Definitions for using threaded, balanced, binary trees
	C modules	atom.c bitvect.c cdeflate.c cnbit.c cnone.c cskphuff.c dfstubs.c dfgroup.c dfutil.c dynarray.c glist.c hbitio.c hbuffer.c hdfalloc.c hfiledd.c linklist.c maldebug.c mcache.c mstdio.c tbbt.c	Internal storage routines for handling atoms Routines that operate ordered sets of bits, or bit vectors Internal I/O routines for HDF gzip deflate encoding Internal I/O routines for HDF N-bit encoding Internal I/O routines for HDF noencoding Internal I/O routines for HDF Skipping Huffman encoding V3.x stubs for V4.0 H-level I/O routines Low-level routines (DF*) for implementing groups General-purpose utility routines Internal routines that handle dynamic storage Implementation of general list HDF bit level I/O routines Routines that manage buffered elements HDF routines for memory management Routines that manage DDs and DD blocks Internal storage routines for handling generic linked lists Utility routines for memory management Modified version of Berkley code for manipulating memory pool HDF stdio-like routines Routines for using threaded, balanced, binary trees
	FORTRAN interface and support	dff.c dff.f dfutilf.c dfutilff.f hfilef.c hfileff.f	C stubs for low-level I/O routines FORTRAN stubs for low-level I/O routines C stubs for general-purpose utility routines FORTRAN stubs for general-purpose utility routines C stubs for low-level routines FORTRAN stubs for low-level routines
Mac only	Header files	dir_mac.h sys_dir_mac.h	Definitions for dir_mac.c Additional definitions to be included in dir_mac.h
	C modules	dir_mac.c	Implementation of UNIX-like directory reading for the Macintosh

3.3.5 The HDF Test Suite

In addition to the source code for the HDF library, Versions 3.2 and higher include a test suite. There are two test modules: one for C and one for FORTRAN. Each module tests all of the routines in all of the application interfaces and in the low-level interface. The exact form of these test modules may vary from one release to the next; consult the release code and online test documentation for details.

Every effort has been made to ensure that the test programs provide a thorough and accurate assessment of the health of the HDF library. Although the test suite will greatly improve the reliability of HDF code, it is almost inevitable that some parts of the code will remain untested. Therefore, no guarantees can be made on the basis of test suite performance.

3.3.6 Sample HDF Programs

Sample programs, illustrating some of the common techniques employed by HDF programmers, are available on the HDF web site at hdf.ncsa.uiuc.edu/hdf4.html.

To help users become familiar with HDF, each release includes several sample programs illustrating common techniques employed by HDF programmers.

3.4 Some HDF Conventions

The HDF specification described in the previous chapter is not sufficient to guarantee its success. It is also important that HDF programmers and users adhere to certain conventions. Some guidelines are implicit in the discussions in other sections of this document. Others are presented in the document *NCSA HDF Calling Interfaces and Utilities* for Versions 3.2 and earlier or in the *HDF User's Guide* and the *HDF Reference Manual* for Versions 3.3 and 4.x.

Guidelines not covered elsewhere are introduced in this section.

Naming and Assigning Tags

Tags that are to be made available to a general population of HDF users should be assigned and controlled by NCSA. Tags of this type are given numbers in the range 1 to 32,767. If you have an application that fits this criterion, contact NCSA at the address listed in the front matter at the beginning of this manual and specify the tags you would like. For each tag, your specifications should include a suggested name, information about the type and structure of the data that the tag will refer to, and information about how the tag will be used. Your specifications should be similar to those contained in Chapter 9, *Tag Specifications*. NCSA will assign a set of tags for your application and will include your tag descriptions in the HDF documentation.

Tags in the range 32,768 to 64,999 are user-definable. That is, you can assign them for any private application. If you use tags in this range, be aware that they may conflict with other people's private tags.

Using Reference Numbers to Organize Data Objects

The HDF library itself uses reference numbers solely to distinguish among objects with the same tag. While application programmers may find it convenient to impart some meaning to reference numbers, they should be forewarned that the HDF library will be ignorant of any such meaning.

<p>Note: Users are discouraged from assigning any meaning to reference numbers beyond that imparted by the HDF library.</p>
--

Multiple References

Multiple references to a single data element are quite common in HDF. The low-level routine `Hdupdd` generates a new reference to data that is already pointed to by another DD. If `Hdupdd` is used several times, there may be several DDs that point to the same data element.

It is important to note that when a multiply-referenced data element is deleted or moved, the various DDs that previously pointed to the data element are *not* automatically deleted or adjusted to point to the data element in its new location. Consequently, each DD to be deleted or moved should be checked for multiple references and handled appropriately.

Low-level Interface

4.1 Chapter Overview

This chapter provides a detailed description of the routines that make up the HDF low-level interface, sometimes referred to as the H-level interface.

4.2 Introduction

HDF supports several interfaces which can be categorized as high-level and low-level interfaces:

- High-level interfaces support utilities and applications.
- Low-level interface functions perform basic operations on HDF files.

These levels are illustrated in Figure 4a.

FIGURE 4a

HDF Software Layers

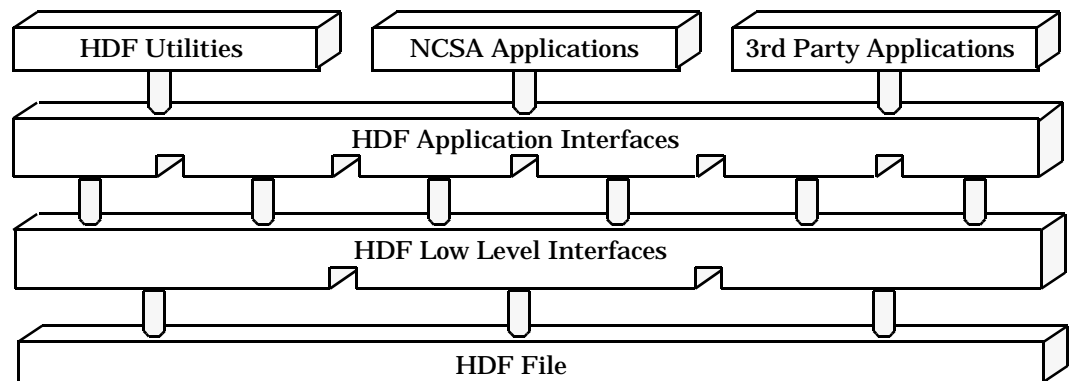

This chapter is concerned only with the low-level interface.

Using these routines of the low-level interface, you will be able to build and manipulate HDF objects of any type, including those of your own design. All HDF applications developed at NCSA use them as basic building blocks.

The low-level routines are all written in C.

4.3 New Low-level Routines with Version 3.2 and Higher

The low-level routines described in this chapter are new with HDF Version 3.2 and higher; they replace the routines provided with earlier versions. The new routines provide better performance and increased functionality and users are strongly advised to use them in new applications. The old routines are supported through emulation, but may be eliminated from the HDF library in a future release.

The new lower layer incorporates the following improvements:

- More consistent data and function types
- More meaningful and extensive error reporting
- Simplification of key lower-level functions
- Simplified techniques to facilitate portability
- Support for alternate forms of physical storage, such as linked blocks storage and storage of the data portion of an object in an external file
- A version tag to indicate which version of the HDF library last changed a file
- Support for simultaneous access to multiple files
- Support for simultaneous access to multiple objects within a single file

The previous lower layer was called the *DF layer* because all routines began with the letters *DF* (e.g., *DFopen* and *DFclose*). The new lower layer is called the *H layer* because all routines begin with the letter *H* (e.g., *Hopen*, *Hclose*, and *Hwrite*). The source modules containing these routines begin with the letter *h* (see Table 3a, "HDF Version 4.x Source Code Modules"):

<code>hfile.c</code>	Basic I/O routines
<code>herr.c</code>	Error-handling routines
<code>hkit.c</code>	General purpose routines
<code>hblocks.c</code>	Routines to support linked block storage
<code>hextelt.c</code>	Routines to support external storage of HDF data elements
<code>hchunks.c</code>	Routines to support chunked elements

4.4 Overview of the Low-level Interface

This section provides the name and purpose of each public function and selected private routines of the low-level interface. The private routines are intended only for internal use by the library. Detailed specifications for many of these routines are provided in Appendix C, *Function Specifications*; detailed specifications for all of these routines are provided as comments in the distributed source code.

Summary of Prefixes

The low-level functions are named with the following prefixes.

TABLE 4-i

Low-level routine prefixes

H	General and file-handling operations
HC	Compression special element operations
HD	DD block operations
HL	Linked block special element operations
HMC	Chunking special element operations
HR	Raster image special element operations
HT	Tag/ref operations
HX	External file special element operations
*P	Routine private to the library. No guarantee of stable external interface; may change without notice.
*I	Static routine private to the library. No guarantee of stable external interface; may change without notice.

Opening and Closing HDF Files

These functions are used to open and close HDF files:

<code>Hopen</code>	Provides an access path to an HDF file and reads all of the DD blocks in the file into memory
<code>Hclose</code>	Closes the access path to a file
<code>HDerr</code>	Closes a file and returns FAIL
<code>Hsetaccesstype</code>	Sets the I/O access type (serial, parallel, ...)

Locating Elements for Access and Getting Information

These routines locate elements or acquire other information about an HDF file or its data objects. Except for `Hendaccess`, they initialize the element that they locate and return an *access ID* that is used in later references to the data element. Calls can include wildcards so that one can search for unknown tags and reference numbers (tag/refs).

<code>Hstartread</code>	Locates an existing data element with matching tag/ref and returns an access ID for reading it
<code>Hnextread</code>	Continues the search with the same access ID
<code>Hendaccess</code>	Disposes of access ID for a tag/ref pair
<code>Hinquire</code>	Returns access information about a data element

<code>Hishdf</code>	Determines whether a file is an HDF file
<code>Hnumber</code>	Returns the number of occurrences of a specified tag/ref pair in a file
<code>Hexist</code>	Determines whether an object exists in an HDF file
<code>Hmpset</code>	Sets pagesize and maximum number of pages to cache on the next open/create operation
<code>Hmpget</code>	Gets last pagesize and max number of pages cached for open/create
<code>Hgetlibversion</code>	Returns version information for the current HDF library
<code>Hgetfileversion</code>	Returns version information for an HDF file
<code>HPgetdiskblock</code>	Gets the offset of a free block in the file
<code>HPfreediskblock</code>	Releases a block in a file to be re-used

Reading and Writing Entire Data Elements

There are two sets of routines for reading and writing data elements. The routines described here are used to store and retrieve entire data elements.

<code>Hputelement</code>	Adds or replaces elements in a file
<code>Hgetelement</code>	Reads data elements in a file

A second set of routines, described in the next section, may be used if you wish to access only part of a data element.

Reading and Writing Part of a Data Element

The second set of routines for reading and writing data elements makes it possible to read or write all or part of a data element. One of the access routines `Hstartread` or `Hstartwrite` must be called before these `Hwrite`, `Hread`, or `Hseek`:

<code>Hstartwrite</code>	Sets up writing to the object with the supplied tag/ref. If the object exists, it will be modified; otherwise it will be created.
<code>Hwrite</code>	Writes data to a data element where the last <code>Hwrite</code> or <code>Hseek</code> stopped. If the space reserved is less than the length to write, then only as data as can fit in the allocated space is written.
<code>Hread</code>	Reads a portion of a data element. It starts at the last position left by an <code>Hread</code> or <code>Hseek</code> call and reads any data that remains in the element up to a specified number of bytes.
<code>Hseek</code>	Sets the access pointer to an offset within a data element. The next time <code>Hread</code> or <code>Hwrite</code> is called, the access occurs from this new position. The location to seek can be specified as an offset from the current location, from the start of the element, or from the end of the element.
<code>Htrunc</code>	Truncates a data set to a specified length.

Manipulating Data Descriptors (DDs)

The routines listed here perform operations on DDs without modifying the data to which the DDs refer. The first list indicates public routines that are available to users and applications; the second list indicates private routines that are used internally by the library.

Public user routines

Hdupdd	Generates new references to a data element that is already referenced from somewhere else
Hdeldd	Deletes a tag/ref pair from the list of DDs
HDcheck_tagref	Checks to see whether a tag/ref pair is in the DD list
HDreuse_tagref	Reuses a data descriptor of a tag/ref pair in a DD list of an HDF file
Hnewref	Returns a reference number that is unique in the file
Htagnewref	Returns a reference number that is unique in the file for a given tag
Hfind	Locates the next object of a search in an HDF file

Private library routines (internal)

HTPcreate	Creates (and attaches to) a tag/ref pair and inserts it into the DD list
HTPselect	Attaches to an existing DD in the DD list
HTPendaccess	Ends access to an attached DD in the DD list
HTPdelete	Marks a tag/ref pair as free and ends access to it
HTPupdate	Changes the offset and/or length of a data object
HTPinquire	Gets the DD information for a DD (i.e. tag/ref/offset/length)
HTPis_special	Checks whether a DD identifier is associated with a special tag
HTPstart	Initializes the DD list from disk, i.e., creates the DD list in memory
HTPinit	Creates a new DD list in memory
HTPsync	Flushes the DD list to disk
HTPend	Closes the DD list to disk

Creating Special Data Elements

Prior to release 3.2, any data element had to be stored contiguously and all of the objects in an HDF file had to be in the same physical file. The contiguous requirement caused many problems, especially with regard to appending to existing objects. If you wanted to append data to an object, the entire data element had to be deleted and rewritten to the end of the file. Later HDF versions introduced alternate methods of storing HDF objects: *linked blocks* and *external elements* at the release of HDF Version 3.2 and *chunking* at HDF Version 4.1. These special elements, plus compression, are discussed in detail in Chapter 10, *Extended Tags and Special Elements*.

Linked blocks improve storage management by allowing elements in a single HDF file to be non-contiguous. The routines listed here operate on linked blocks. The first list indicates the public routines that are available to users and applications; the second list indicates the private routines that are used internally by the library.

Public user routines

HLcreate	Creates a new linked-block special data element
HLconvert	Converts an AID into a linked-block element
HDinqblockinfo	Returns information about linked blocks

Private library routines (internal)

HLPread	Reads some data out of a linked-block element
HLPwrite	Writes out some data to a linked-block element
HLPinquire	Returns information about a linked-block element
HLPendaccess	Closes a linked-block AID
HLPinfo	Returns information about a linked-block element
HLPstread	Opens an access record for reading
HLPstwrite	Opens an access record for writing
HLPseek	Sets position for the next access

External elements allow a single HDF object to be stored in an external file. The following routines operate on external elements:

HXcreate	Creates a new external file special data element
HXsetcreatedir	Sets the directory variable for creating external file
HXsetdir	Sets the directory variable for locating external file

It is not currently possible to store a single object (such as a very large data set) in multiple files. Nor can multiple objects be stored in one external file.

Once they are created with the routines `HLcreate` and `HXcreate`, these special data elements can be accessed with the routines used for normal data elements. These routines have two modes of operation. Calling `HLcreate` with a tag/ref that does not exist in a file will create a new element with the given tag/ref pair which will be stored as linked blocks. On the other hand, if the tag/ref pair already exists in the file, the referenced object will be promoted to linked block status. All data which had been stored in the object before the promotion will be retained. `HXcreate` behaves similarly.

Chunking allows elements in large arrays to be stored as chunks in such a way that I/O performance can be significantly improved. The routines listed here perform operations on chunking elements. The first list indicates the public routines that are available to users and applications; the second list indicates the private routines that are used internally by the library.

Public user routines

HMCcreate	Creates a chunked element.
HMCwriteChunk	Writes out the specified chunk to a chunked element.
HMCreadChunk	Reads the specified chunk from a chunked element.
HMCsetMaxcache	Sets the maximum number of chunks to cache.
HMCPCloseAID	Closes the file but keeps AID active (for <code>Hnextread()</code>).

Private library routines (internal)

HMCpstread	Opens an access record for reading.
------------	-------------------------------------

HMCPstwrite	Opens an access record for writing.
HMCPseek	Sets the seek position.
HMCPchunkread	Reads a single chunk from a chunked element.
HMCPread	Reads a more arbitrarily sized piece of data from a chunked element.
HMCPchunkwrite	Writes out a single chunk of data to a chunked element.
HMCPwrite	Writes out a more arbitrarily sized piece of data to a chunked element.
HMCPinquire	Implements Hinqwire for a chunked element.
HMCPendaccess	Closes a chunked element AID
HMCPinfo	Returns information about a chunked element.

Compression provides for the compression of data sets. The routines listed here perform those compression operations. The first list indicates the public routines that are available to users and applications; the second list indicates the private routines that are used internally by the library.¹

Public user routines

HCcreate Create a compressed data element

Private library routines (internal)

HCIinit_coder	Set the coder function pointers
HCIinit_model	Set the model function pointers
HCIread_header	Read the compression header info from a file
HCIstaccess	Start accessing a compressed data element.
HCIwrite_header	Write the compression header info to a file
HCPcloseAID	Get rid of the compressed data element data structures
HCPdecode_header	Decode the compression header info from a memory buffer
HCPencode_header	Encode the compression header info to a memory buffer
HCPendaccess	Close the compressed data element and free the AID
HCPinfo	return info about a compressed element
HCPinquire	Inquire information about the access record and data element.
HCPmstdio_endaccess	Close the compressed data element
HCPmstdio_inquire	Inquire information about the access record and data element
HCPmstdio_read	Read in a portion of data from a compressed data element
HCPmstdio_seek	Seek to offset within the data element
HCPmstdio_stread	start read access for compressed file
HCPmstdio_stwrite	start write access for compressed file

1. These are the general compression functions. Additional compression functions, specific to each compression style, can be found in the compression style-specific modules in the source code distribution. As of HDF Version 1.4r4, those modules included the files `c*.c` (e.g., `cdeflate.c.`, `crle.c`) in the directory `./hdf/src/`.

HCPmstdio_write	Write out a portion of data from a compressed data element
HCPquery_encode_header	Query the length of compression header for a memory buffer
HCPread	Read in a portion of data from a compressed data element.
HCPseek	Seek to offset within the data element
HCPstread	Start read access on a compressed data element.
HCPstwrite	Start write access on a compressed data element.
HCPwrite	Write out a portion of data from a compressed data element.
HRPcloseAID	Free memory but keep AID active
HRPconvert	Wrap an existing raster image with the special element routines.
HRPendaccess	Free AID
HRPinfo	Return info about a compressed raster element
HRPinquire	Retrieve information about a compressed raster element
HRPread	Read some data out of compressed raster element
HRPseek	Set the seek posn
HRPstread	Open an access record for reading
HRPstwrite	Open an access record for reading
HRPwrite	Write data out to a compressed raster image

General special element routines: In addition to the routines specific to a particular type of special element, the library provides general routines for use on any special element:

HDget_special_info	Gets information about a special element
HDset_special_info	Resets information about a special element

Development Routines

The HDF library provides the following developer-level routines that simplify the task of writing HDF applications. Many of these routines mirror basic C library functions which are, unfortunately, not always completely portable in their library form:

HDgettagname	Returns a pointer to a text string describing a given tag
HDgetspace	Allocates space
HDfreespace	Frees space
HDclearspace	Creates storage on the heap for a number of items of the given size
HDregetspace	Resizes to the new given size
HDstrcat	Appends a string to the end of another string
HDstrcmp	Compares two strings
HDstrncmp	Compares two strings up to a given number of characters
HDstrcpy	Copies a string from one location to another

HDstrncpy	Copies a string from one location to another up to a given number of characters
HDstrlen	Returns the length of a string
HDstrchr	Returns the position of a character within a string
HDstrrchr	Returns the position of the last occurrence of a character within a string
HDstrtol	Converts the initial portion of a string to a type long int representation
HDc2fstr	Converts a C string into a Fortran string using the <i>in place</i> approach
Hdf2cstring	Converts a Fortran string to a C string
HDpackFstring	Converts a C string to a Fortran string
HDflush	Flushes the HDF file to disk
HDgettagnum	Returns the tag number for a text description of a tag
HDgetNTdesc	Returns a text description of a number type
HDfidtoname	Returns the filename that the given file identifier corresponds to
Hexist	Locates an object in an HDF file
HDgetc	Reads a byte from a data element
HDputc	Writes a byte to a data element
Hlength	Returns the length of a data element
Hoffset	Gets the offset of a data element in a file
Htrunc	Truncates a dataset to the given length
Hcache	Sets low-level caching for a file
HDvalidfid	Checks whether a file identifier is valid

Error Reporting

The HDF library incorporates the notion of an *error stack*. This allows much of the context to be known when trying to decipher an error message.

Error reporting is handled by the following routines:

HEprint	Prints out all of the errors on the error stack to a specified file
HEclear	Clears the error stack
HERROR	Reports an error and pushes the following information onto the error stack. <ul style="list-style-type: none">• Error type• Source file name• Line number and the name of the function reporting the error
HEreport	Adds a text string to the description of the most recently reported error (Note: only one text string per error)
HEstring	Returns error description
HEpush	Pushes an error onto the stack

`HEvaluate` Returns an error off the error stack

Standard C does not enable the code inside a function to know the name of the function. Therefore, to use the macro `HERROR` to report errors, there must exist a variable `FUNC` which points to a string containing the name of the reporting function.

Other

The `Hsync` routine has been defined and implemented to synchronize a file with its image in memory. Currently it is not very useful because the HDF software includes no buffering mechanism and the two images are always identical. `Hsync` will become useful when buffering is implemented:

`Hsync` Synchronizes the stored version of an HDF file with the image in memory

Sets and Groups

5.1 Chapter Overview

This chapter discusses the roles of the following sets and groups in organizing data stored in an HDF file:

Raster image sets (RIS)	Raster image groups (RIG)
Scientific data sets (SDS)	Scientific data groups (SDG) Numeric data groups (NDG) SDG-like NDGs
Vsets	Vgroups and Vdatas
Raster-8 sets	(obsolete)

This chapter introduces several tags used in support of sets and groups. All of these tags are fully described in Chapter 9, *Tag Specifications*, and are listed in the table in Appendix A, *Tags and Extended Tag Labels*.

5.2 Data Sets

HDF files frequently contain several closely related data objects. Taken together, these objects form a *data set* which serves a particular user requirement. For example, five or six data objects might be used to describe a raster image; eight or more data objects might be used to describe the results of a scientific experiment.

The HDF mechanism for specifying and controlling data sets is the group. The data element of a *group* consists of a single record listing the tag/refs for all the objects contained in the data set. For example, the raster image groups described in the following sections each contain three tag/refs that point to three data objects that, taken as a set, fully describe an 8-bit raster image.

5.2.1 Types of Sets

The current HDF implementation supports three kinds of sets:

Raster image set	A set containing a raster image and descriptive information such as the image dimensions and an optional color lookup table
Scientific data set	A set containing a multidimensional array and information describing the data in the array
Vset	A general grouping structure containing any kinds of HDF objects that a user wishes to include

Each HDF set is defined with a minimum collection of data objects that will make sense when the set is used. For example, every raster image set must contain at least the following data objects:

Raster image group	The list of the members of the set
Image dimension record	The width, height, and pixel size of the raster image
Raster image data	The pixel values that make up the image

In addition to the required objects, a set may include optional data objects. An 8-bit raster image set, for instance, often contains a palette, or color lookup table, which defines the red, green, and blue values associated with each pixel in the raster image.

5.2.2 Calling Interfaces for Sets

NCSA provides calling interfaces for all the HDF sets that it supports. These interfaces provide routines for reading and writing the data associated with each set. The libraries currently supported by NCSA are callable from either C or FORTRAN programs.

In addition to the libraries, a growing number of command-line utilities are available to manipulate sets. For example, a utility called `r8tohdf` converts one or more raw raster images to HDF 8-bit raster image set format.

The calling interfaces are described in the document *NCSA HDF Calling Interfaces and Utilities* for Versions 3.2 and earlier and in the *HDF User's Guide* and *HDF Reference Manual* for Versions 3.3 and 4.x.

5.3 Groups

As discussed above, HDF data objects are frequently associated as sets. But without some explicit identifying mechanism, there is often no way to tie them together. To address this problem, HDF provides a grouping mechanism called a **group**. A group is a data object that explicitly identifies all of the data objects in a set.

Since a group is just another type of data object, its structure is like that of any other data object; it includes a DD and a data element. But instead of containing the pixel values for a raster image or the dimensions of an array, a group data element contains a list of tag/refs for the data objects that make up the corresponding set.

A **group tag** can be defined for any set. For instance, the **raster image group** tag (DFTAG_RIG) is used to identify members of raster image sets; the RIG data element lists the tag/refs for a particular raster image set.

An Example

Suppose that the two images shown in Figure 2d, "Physical Representation of Data Objects," are organized into two sets with group tags. Since they are raster images, they may be stored as RIGs. Figure 5a, "Physical Organization of Sample RIG Groupings," illustrates the use of RIGs with these images.

FIGURE 5a

Physical Organization of Sample RIG Groupings

Offset	Item	Contents
0	FH	0e031301 <i>(HDF magic number)</i>
4	DDH	10 0L
10	DD	DFTAG_FID 1 130 4
22	DD	DFTAG_FD 1 134 41
34	DD	DFTAG_LUT 1 175 768
46	DD	DFTAG_ID 1 943 4
58	DD	DFTAG_RI 1 947 240000
70	DD	DFTAG_ID 2 240947 4
82	DD	DFTAG_RI 2 240951 240000
94	DD	DFTAG_RIG 1 480951 12
106	DD	DFTAG_RIG 2 480963 12
118	DD	DFTAG_NULL <i>(Empty)</i>
130	Data	sw3
134	Data	solar wind simulation: third try. 8/8/88
175	Data	... <i>(Data for image palette)</i>
943	Data	400, 600 ... <i>(Data for 1st image dimension record)</i>
947	Data	... <i>(Data for 1st raster image)</i>
240947	Data	400, 600 ... <i>(Data for 2nd image dimension record)</i>
240951	Data	... <i>(Data for 2nd raster image)</i>
480951	Data	DFTAG_IP8/1, DFTAG_ID/1, DFTAG_RI/1 <i>(Tag/refs for 1st RIG)</i>
480963	Data	DFTAG_IP8/1, DFTAG_ID/2, DFTAG_RI/2 <i>(Tag/refs for 2nd RIG)</i>

The file depicted in this figure contains the same raster image information as the file in Figure 2d, "Physical Representation of Data Objects," but the information is organized into two sets. Note that there is only one palette (DFTAG_IP8/1) and that it is included in both groups.

5.3.1 General Features of Groups

Figure 5a, "Physical Organization of Sample RIG Groupings," also illustrates a number of important general features of groups:

- The contents of a group must be consistent with one another. Since the palette (DFTAG_IP8) is designed for use with 8-bit images, the image must be an 8-bit image.
- An application program can easily process all of the images in the file by accessing the groups in the file. The non-RIG information in the example can be used or ignored, depending on the needs and capabilities of the application program.
- There is usually more than one way to group sets. For example, an extra copy of the image palette (DFTAG_IP8) could have been stored in the file so that each grouping would have its own image palette. That is not necessary in this instance because the same palette is to be used with both images. On the other hand, there are two image dimension records in this example, even though one would suffice.

- Group status does not alter the fundamental role of an HDF object; it is still accessible as an individual data object despite the fact that it also belongs to a larger set.
- A group provides an index of the members of a set. There is nothing to prevent the imposition of other groupings (indexes) that provide a different view of the same collection of data objects. In fact, HDF is designed to encourage the addition of alternate views.

The following sections formally describe raster image sets (RIS), scientific data sets (SDS), Vsets, and several related groups. The last section of this chapter discusses an obsolete structure known as the raster-8 set.

5.4 Raster Image Sets (RIS)

The raster image set (RIS) provides a framework for storing images and any number of optional image descriptors. An RIS always contains a description of the image data layout and the image data. It may also contain color look-up tables, aspect ratio information, color correction information, associated matte or other overlay information, and any other data related to the display of the image.

5.4.1 Raster Image Groups (RIG)

Tying everything together is the raster image group (RIG, see Figure 5a, "Physical Organization of Sample RIG Groupings," and the related discussion for an example). An RIG contains a list of tag/refs that point in turn to the data objects that make up and describe the image.

The number of entries in an RIG is variable and most of the descriptive information is optional. Complex applications may include references to image-modifying data, such as the color table and aspect ratio, along with the reference to the image data itself. Simple applications may use simple application-level calls and ignore specialized video production or film color correction parameters.

NCSA currently supports two RIG calling interfaces: *RIS8* and *RIS24*. These interfaces are described in the document *NCSA HDF Calling Interfaces and Utilities* for Versions 3.2 and earlier and in the *HDF User's Guide* and *HDF Reference Manual* for Versions 3.3 and 4.x.

5.4.2 RIS Tags

RIS implementations must fully support all of the tags presented in Table 5a.

TABLE 5a

RIS Tags

Tag	Contents of Data Element
DFTAG_RIG	Raster image group
DFTAG_ID	Image dimension record
DFTAG_RI	Raster image data

With these tags, images can be stored and read from HDF files at any bit depth, with several different component ordering schemes. As illustrated in Figure 5b, the RIG tag points to the collection of tag/refs that fully describe the RIS. The data element attached to the tag `DFTAG_ID` specifies the dimensions of the image, the number type of the elements that make up its pixels, the number of elements per pixel, the interlace scheme used, and the compression scheme used, if any. The data element attached to the tag `DFTAG_RI` contains the actual raster image data.

FIGURE 5b

RIS Tags

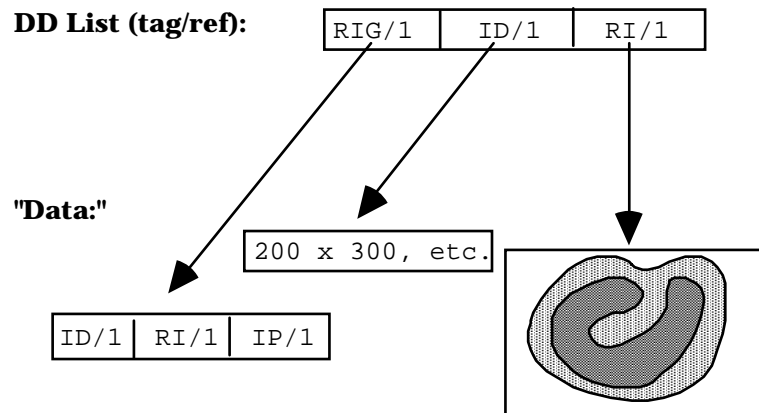

The tags listed in Table 5b identify optional RIS information such as color properties and aspect ratio. Note that the RI interface supports only DFTAG_LUT at this time; the other tags in Table 5b are defined but the interfaces have not been implemented.

TABLE 5b

Optional RIS Tags

Tag	Contents of Data Element
DFTAG_XYP	XY position of image
DFTAG_LD	Look-up table dimension record
DFTAG_LUT	Color look-up table for non true-color images
DFTAG_MD	Matte channel dimension record
DFTAG_MA	Matte channel data
DFTAG_CCN	Color correction factors
DFTAG_CFM	Color format designation
DFTAG_AR	Aspect ratio
DFTAG_MTO	Machine-type override

Figure 5c illustrates the structure of an RIS that contains an image palette (DFTAG_IP8).

FIGURE 5c

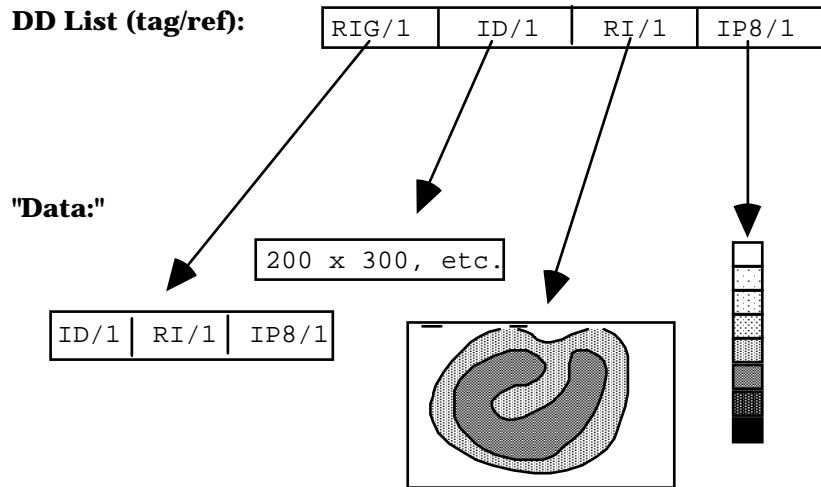
RIS Tags for Sets Containing a Palette**5.4.3 Raster Image Compression**

HDF currently supports the following raster image compression tags:

- DFTAG_RLE Run-length encoding
- DFTAG_IMCOMP Aerial averaging
- DFTAG_JPEG JPEG compression

RIG support does not require support for all compression tags. Be sure to provide a suitable error message to the user when an unknown compression tag is encountered.

Since new forms of data compression can be added to HDF raster images, incompatibilities can arise between old libraries and files created by newer libraries. For example, HDF Versions 3.3 and later include JPEG compression for images. A JPEG-compressed raster image in a file created by an HDF Version 4.1 library cannot be read by an HDF Version 3.2 library.

5.5 Scientific Data Sets

The scientific data set (SDS) provides a framework for storing multidimensional arrays of data with descriptive information that enhances the data. Current specifications support the following types of numbers in SDS arrays.

- 8-bit, 16-bit, and 32-bit signed and unsigned integers
- 32-bit and 64-bit floating point numbers

Data in an SDS can be stored either as two's complement big endian integers, as IEEE Standard floating point numbers, or in *native mode*, the format used by the machine from which they were written.

The user interface for storing and retrieving SDSs is fully described in the document *NCSA HDF Calling Interfaces and Utilities* for Versions 3.2 and earlier and in the *HDF User's Guide* and *HDF Reference Manual* for Versions 3.3 and 4.x.

5.5.1 Backward and Forward Compatibility

One of NCSA's concerns in HDF development is always to maximize backward and forward compatibility; as much as possible, any application written to use HDF should be able to read data files written with an older or a newer version of the libraries. To maximize this compatibility, NCSA had to consider the following factors in upgrading the SDS capabilities:

- Support for future variations (e.g., new number types, data compression, and new physical arrangements for SDS storage)
- Older versions of the library should be able to read new data files if the data itself can be interpreted by the older version. To do so, the older version must be able to determine whether the data in a given data object will be comprehensible to it. For example, if a newly created file contains 32-bit IEEE floating point or Cray floating point data objects, older versions of the library should be able determine that fact then read and interpret the data.
- New libraries must be able to read and interpret files created by older versions.

Unfortunately, such compatibility concerns yield an SDS structure somewhat more complex than would otherwise be the case. Two examples illustrate the problem:

- HDF 3.2 development had to accommodate the fact that HDF Version 3.1 and previous versions only supported 32-bit IEEE floating-point numbers and Cray floating point numbers in SDSs. SDSs in HDF versions since Version 3.2 support 8-bit, 16-bit, and 32-bit signed and unsigned integers, 32-bit and 64-bit floating-point numbers, and the local machine format (*native mode*) for all supported architectures.
- HDF 3.3 includes support for the netCDF data model, which involved the creation of an entire new structure for supporting netCDF objects, based on Vgroups and Vdatas. At the same time, a goal of HDF 3.3 was to harmonize the SDS and the netCDF data model, which was best accomplished by storing SDS objects in the same way that netCDF objects are stored. In order to maintain backward compatibility, two structures had to be created for every SDS or netCDF object: one that could be recognized by older HDF libraries, and the new structure.

In the following sections we describe how the first problem was solved. A later issue of this manual will describe how the second problem was addressed.

5.5.2 Internal Structures

The SDS capability was substantially enhanced for HDF Version 3.2. Previous versions employed a structure known as a *scientific data group* (SDG); Version 3.2 and subsequent versions use the *numeric data group* (NDG). To accommodate the enhanced structure and to remain compatible with previous releases, the current HDF library supports the following scientific and numerical data groups:

SDGs Created by old libraries and containing 32-bit IEEE and Cray floating-point data.

NDGs Created by the newer libraries (Version 3.2 and later) and containing any acceptable floating-point or non-floating-point data. This data group will not be recognized by old libraries.

The NDG structure supports 8-bit, 16-bit, and 32-bit signed and unsigned integers, and 32-bit and 64-bit floating-point numbers. It also supports native mode, data sets written to HDF files in the local machine format.

SDG-like NDGs

Created by the new library and containing IEEE 32-bit floating-point data only. The old libraries will recognize and interpret these numerical data groups correctly.

The following sections describe the SDG, NDG, and SDG-like NDG structures.

5.5.3 SDG Structures

SDGs must contain at least the data objects listed in Table 5c.

TABLE 5c

Required SDG Tags

Tag	Contents of Data Element
DFTAG_SDG	Scientific data group.
DFTAG_SDD	Dimension record for array-stored data. Includes the rank (number of dimensions), the size of each dimension, and the tag/refs representing the number type of the array data and of each dimension. All SDG number types are 32-bit IEEE floating-point.
DFTAG_SD	Scientific data.

In addition to the required data objects listed above, SDGs may contain any of the objects listed in Table 5d. Note that the optional data objects are the same for SDGs, NDGs, and SDG-like NDGs; the only differences are the number types that may be used.

TABLE 5d

Optional SDG, NDG, and SDG-like NDG Tags

Tag	Contents of Data Element
DFTAG_SDS	Scales of the different dimensions. To be used when interpreting or displaying the data (32-bit floating point numbers only for SDGs and SDG-like NDGs).
DFTAG_SDL	Labels for all dimensions and for the data. Each of the dimension labels can be interpreted as an independent variable; the data label is the dependent variable.
DFTAG_SDU	Units for all dimensions and for the data.
DFTAG_SDF	Format specifications to be used when displaying values of the data.
DFTAG_SDM	Maximum and minimum values of the data. (32-bit floating point numbers only for SDGs and SDG-like NDGs.)
DFTAG_SDC	Coordinate system to be used when interpreting or displaying the data.

As illustrated in Figure 5d, the SDG tag points to the collection of tag/refs that define the SDG.

FIGURE 5d

SDG Structure

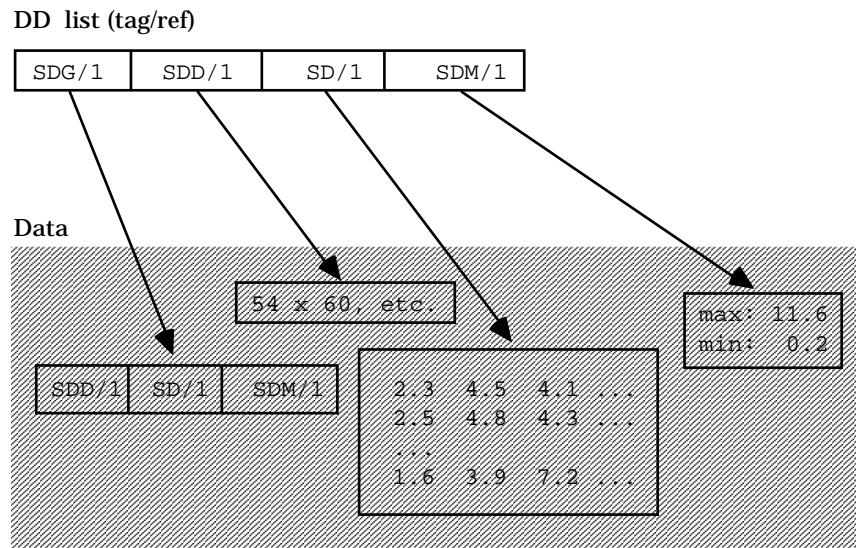

5.5.4 NDG Structures

NDGs must contain at least the data objects listed in Table 5e

TABLE 5e

Required NDG Tags

Tag	Contents of Data Element
DFTAG_NDG	Numerical data group.
DFTAG_SDD	Dimension record for array-stored data. Includes the rank (number of dimensions), the size of each dimension, and the tag/refs representing the number types of the data and of each dimension. In HDF 3.2, the number types of dimension scales must be the same as that of the array-stored data. Later implementations allow dimension scales to be typed separately.
DFTAG_SD	Scientific data.
DFTAG_NT	Number type of the data set. Default is the most recent DFSDsetNT() setting. If DFSDsetNT() has not been called, the default will be 32-bit IEEE floating-point.

In addition to these required data objects, an NDG may contain any of the data objects listed in Table 5d, "Optional SDG, NDG, and SDG-like NDG Tags," on page 44.

As illustrated in Figure 5e, the basic NDG and SDG structures are identical. The first clue to the difference is that the NDG tag replaces the SDG tag. This is a flag to prevent older libraries from stumbling over the more important difference; the NDG data element can accommodate data that pre-Version 3.2 libraries cannot interpret. The new tag ensures that older libraries will not recognize the data object and thus will not try to interpret the new data types. For example, NDG data can include number types or a data compression scheme that a pre-Version 3.2 library will not recognize.

FIGURE 5e

NDG Structure

DD list (tag/ref)



Data

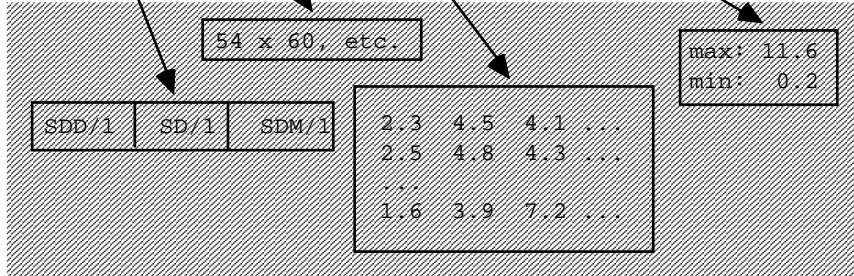

5.5.5 SDG-like NDG Structures

As we have said earlier,

- SDGs, the SDS grouping structure available prior to HDF Version 3.2, could include only 32-bit floating point and Cray floating point numbers.
- NDGs, available since Version 3.2, can include 8-bit, 16-bit, and 32-bit signed and unsigned integers, and 32-bit and 64-bit floating point numbers.
- SDG-like NDGs, also available since Version 3.2, distinguish SDSs that can still be read by the older versions of the library.

This backward compatibility is achieved by examining every SDS that is written to an HDF file. If the SDS is compatible with older libraries, it is written to the file with both SDG and NDG structures. If it is not compatible with older libraries, only the NDG structure is used.

Table 5f lists the objects that SDG-like NDGs must contain.

TABLE 5f

Required SDG-like NDG Tags

Tag	Contents of Data Element
DFTAG_NDG	Numerical data group.
DFTAG_SDG	Scientific data group.
DFTAG_SDLINK	The NDG and SDG linked to the scientific data set in this group.
DFTAG_SDD	Dimension record for array-stored data. Includes the rank (number of dimensions), the size of each dimension, and the tag/refs representing the number types of the data and of each dimension. In an SDG-like NDG, the number types are all 32-bit IEEE floating-point.
DFTAG_SD	Scientific data.

SDG-like NDGs can include the same optional data objects as described for SDGs and NDGs in Table 5d, "Optional SDG, NDG, and SDG-like NDG Tags," on page 44.

Figure 5f illustrates the SDG-like NDG structure.

FIGURE 5f

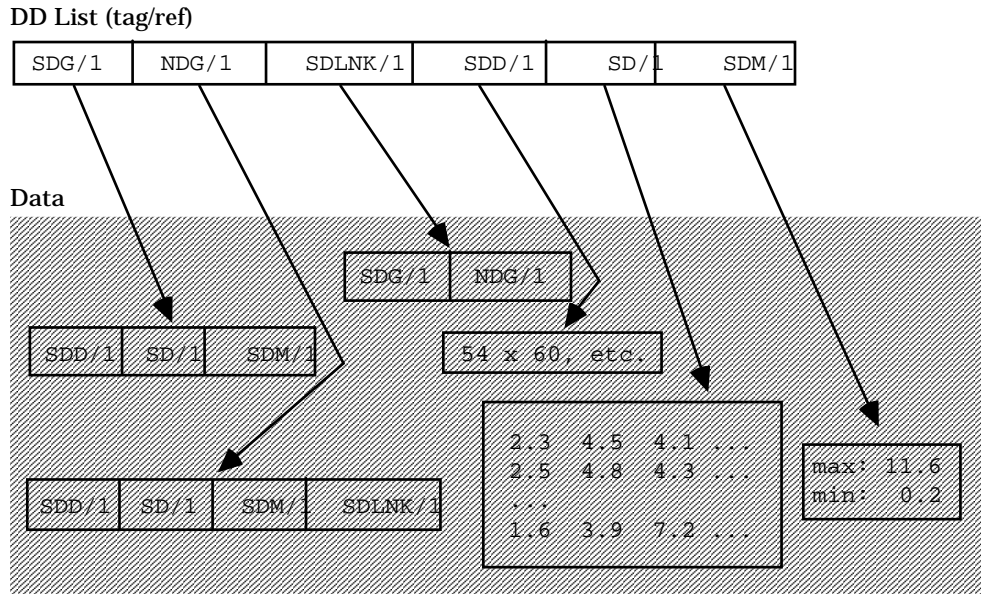
SDG-like NDG Structure**5.5.6 Compatibility with Future NDG Structures**

Future HDF releases will probably support additional optional SDS features. These features will fall into the following categories:

Optional and compatible features

Optional features that are compatible with older HDF versions even though they may not be supported in the older libraries.

For example, a new time stamp attribute might be added. The time stamp would not be understood by older libraries, but it would not render them unable to read the SDS data either.

Optional and incompatible features

Optional new features that may render the data unreadable by older HDF libraries.

For example, a compression attribute could be added. Older HDF libraries that contain no compression routines would not be able to read the compressed data.

A tag numbering convention has been developed to address this problem:

Required tags

These tags are listed in Table 5c, "Required SDG Tags," on page 44; Table 5e, "Required NDG Tags," on page 45; and Table 5f, "Required SDG-like NDG Tags," on page 46. All SDSs must contain all of the tags in at least one of these sets. (See Chapter 9, "Tag Specifications," for the assigned tag numbers.)

Optional-incompatible tags

Tags for new SDS features that might render the data set unreadable by older libraries are each assigned a number t that falls in a special range determined by the constants `DFTAG_EREQ` and `DFTAG_BREQ`. That is, t must have a value such that `DFTAG_EREQ < t`

< DFTAG_BREQ. When old software encounters a tag in this range that it is not able to interpret, it should not process the group.

Optional-compatible tags

These tags can have any valid tag number not allocated to one of the other two categories.

5.6 Vsets, Vdatas, and Vgroups

Vsets, Vdatas, and Vgroups enable users to create their own grouping structures. Unlike RIGs, SDGs, and NDGs, HDF imposes no required structure; they are implemented almost entirely at the user level and are not specified in detail in HDF or in this document.¹ The only specifications define DFTAG_VG, DFTAG_VH, and DFTAG_VS and the formats of their respective data elements. A detailed discussion similar to that for the other grouping structures is, therefore, inappropriate here. Detailed information regarding the DFTAG_VG, DFTAG_VH, and DFTAG_VS tags can be found in Chapter 9, "Tag Specifications." Conceptual and usage information can be found in the document *NCSA HDF Vset Version 2.0* for HDF Versions 3.2 and earlier and in the *HDF User's Guide* and the *HDF Reference Manual* for HDF Versions 3.3 and 4.x.

FIGURE 5g

Illustration of a Vset

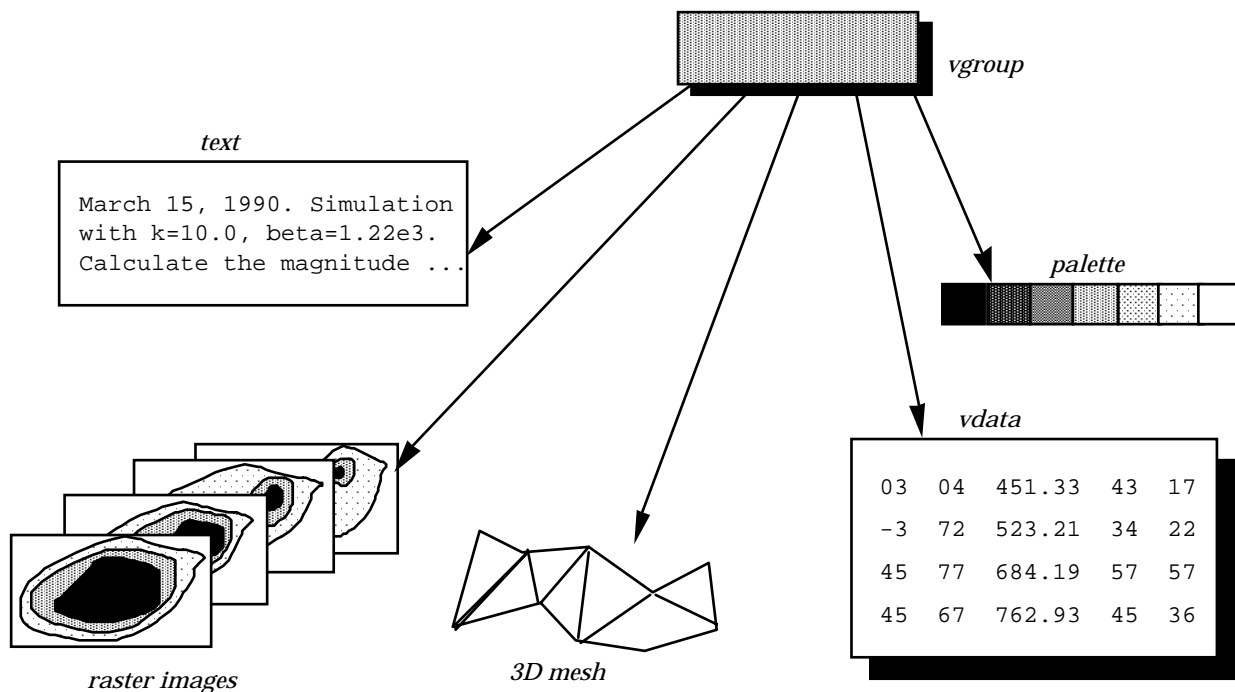

An HDF *Vset* can contain any logical grouping of HDF data objects within an HDF file. Vsets resemble the UNIX file system in that they impose a basically hierarchical structure but also allow cross-linked data objects. Unlike SDSs and RISs, Vsets have no prespecified content or structure;

1. Specialists in various fields are developing application program interfaces (APIs) that are becoming accepted standard interfaces within their fields. Since these APIs are implemented with high level HDF functionality and using the standard HDF user interface, they are user-level applications from the HDF development team's point of view. From the final enduser's point of view, however, these APIs create a new level of user interface. When necessary, technical specifications for these APIs and the associated interfaces will be presented by the specialized developers.

users can use them to create structural relationships among HDF objects according to their needs. Figure 5g illustrates a Vset.

A Vset is identified by a **Vgroup**, an HDF object that contains information about the members of the Vset. The tag `DFTAG_VG` identifies the Vgroup which contains the tag/refs of its members, an optional user-specified name, an optional user-specified class, and fields that enable the Vgroup to be extended to contain more information.

The only required Vgroup tag is the tag that defines the Vgroup itself.

TABLE 5g

The Vgroup Tag

Tag	Contents of Data Element
DFTAG_VG	Vgroup

Vgroups are fully described in the document *NCSA HDF Vset, Version 2.0* for Versions 3.2 and earlier and in the *HDF User's Guide* and *HDF Reference Manual* for Versions 3.3 and 4.x.

5.7 The Raster-8 Set (Obsolete)

Current HDF versions use the raster image set (RIS) to manage raster images. But before the RIS was implemented, a simpler, less flexible set called the raster-8 set was used for storing 8-bit raster images. This set is no longer supported in the HDF software, although it may turn up in some older HDF files.¹

5.7.1 Raster-8 Sets

The *raster-8 set* is defined by a set of tags that provide the basic information necessary to store 8-bit raster images and display them accurately without requiring the user to supply dimensions or color information. The raster-8 set tags are listed in Table 5h.

TABLE 5h

Raster-8 Set Tags

Tag	Contents of Data Element
DFTAG_RI8	8-bit raster image data
DFTAG_CI8	8-bit raster image data compressed with run-length encoding
DFTAG_II8	IMCOMP compressed image data
DFTAG_ID8	Image dimension record
DFTAG_IP8	Image palette data

Software that does not support `DFTAG_CI8` or `DFTAG_II8` must provide appropriate error indicators to higher layers that might expect to find these tags.

5.7.2 Compatibility Between Raster-8 and Raster Image Sets

To maintain backward compatibility with raster-8 sets, the RIS interface stores tag/refs for both types of sets. For example, if an image is stored as part of a raster image set, there is one copy each of the image dimension data, the image data, and the palette data. But there were two sets of

1. In fact, during the first three years that RIS was used, the HDF software stored raster images in both RIS and raster-8 sets.

tag/refs pointing to each data element: one for the RIS and one for the raster-8 set. The image data, for example, is associated with the tags `DFTAG_RI8` and `DFTAG_RI`.

Note: Raster-8 set support will not be maintained in future HDF releases.

Note that future HDF releases will phase out support for the raster-8 set. Therefore, new software should not expect to find both raster-8 and RIS structures supporting 8-bit raster images. Eventually, only RIS structures will be supported.

5.8 Deleted information from "Vsets, Vdatas, and Vgroups:"

A table structure known as a *Vdata* is often used as a data object in connection with Vsets. The data in a Vdata is organized into fields. Each field is identified by a unique fieldname. The type of each field may be any of the data types supported by the SDS interface: 8-, 16-, and 32-bit integers (signed or unsigned), and 32- and 64-bit floating point numbers. Several fields of different types may exist within a Vdata.

The use of Vdatas requires two tags, `DFTAG_VS` and `DFTAG_VH`, listed in Table 5i. The flexibility of the Vgroup structure allows the use of any HDF tag.

TABLE 5i

Optional Vgroup Tags

Tag	Contents of Data Element
<code>DFTAG_VS</code>	Vdata.
<code>DFTAG_VH</code>	Vdata description.
Any HDF tag	The flexibility of the Vgroup structure allows the optional use of any HDF tag.

Annotations

6.1 Chapter Overview

This chapter introduces annotations, HDF data objects used to annotate HDF files and objects.

The tags introduced in this chapter are fully described in Chapter 9, "*Tag Specifications*," and are listed in the table in Appendix A, "*Tags and Extended Tag Labels*."

6.2 General Description

It is often useful to attach a text annotation to an HDF file or its contents and to store that annotation in the same HDF file. HDF provides this capability in two ways: through the *annotation* data object and by the assignment of attributes. This chapter discusses annotations.

The data element of an annotation is a sequence of ASCII characters that can be associated with any of three types of objects:

- The file itself
- An individual HDF data object in the file
- A tag that identifies a data element

The current annotation interface supports only the first two.

Annotations come in two forms:

Label	A short, NULL-terminated string. Labels may include no embedded NULLs.
Description	A longer and more complex body of text of a pre-defined length. Descriptions may contain embedded NULLs.

Annotations are never required; they are used strictly at the discretion of the creator or user of an HDF file.

Table 6a shows the currently defined annotation types and their assigned tags.

TABLE 6a

Annotation Tags

	Label Types	Description Types
File annotations	DFTAG_FID	DFTAG_FD
Object annotations	DFTAG_DIL	DFTAG_DIA
Tag annotations	DFTAG_TID	DFTAG_TD

The annotation interface is fully described in the document *NCSA HDF Calling Interfaces and Utilities* for Versions 3.2 and earlier and in the *HDF User's Guide* and *HDF Reference Manual* for Versions 3.3 and 4.x.

6.3 File Annotations

Any HDF file can include label annotations (DFTAG_FID) and/or description annotations (DFTAG_FD). The file annotation interface routines provided in the HDF software read and write file labels and file descriptions.

6.4 Object Annotations

HDF data object annotation is complicated by the fact that you must uniquely identify the object being annotated. Since a tag/ref uniquely identifies a data object, the data object that a particular annotation refers to can be identified by storing the object's tag and reference number with the annotation.

Note that an HDF annotation is itself a data object, so it has its own DD. This DD has a tag/ref that points to the data element containing the annotation. The annotation data element contains the following information:

- The tag of the annotated object
- The reference number of the annotated object
- The annotation itself

For example, suppose you have an HDF file that contains three scientific data sets (SDSs). Each SDS has its own DD consisting of the SDS tag DFTAG_NDG and a unique reference number, as illustrated in Figure 6a.

FIGURE 6a

Three SDS Tag/refs

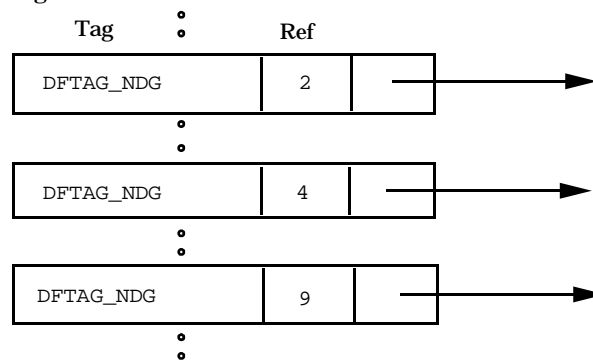

Suppose you wish to attach the following annotation to the second SDS:

Data from black hole experiment 8/18/87.

This text will be stored in a description annotation data object. The data element will include the tag/ref, DFTAG_NDG/4, and the annotation itself. Figure 6b illustrates the annotation data object.

FIGURE 6b

Sample Annotation Data Object**Getting Reference Numbers for Object Annotations**

To use annotation routines, you need to know the tags and reference numbers of the objects you wish to annotate.

The following routines return the most recent reference number used in either reading or writing the specified type of data object:

- DFSDlastref SDS data objects
- DFR8lastref RIS data objects
- DFPlastref Palettes
- DFANlastref Annotations

Reference numbers for other objects can be obtained with the routine `Hfindnextref`, a low level HDF routine that searches an HDF file sequentially for reference numbers associated with a given tag.

These routines are described in the document *NCSA HDF Calling Interfaces and Utilities* for Versions 3.2 and earlier and in the *HDF User's Guide* and *HDF Reference Manual* for Versions 3.3 and 4.x.

Scientific Data Sets: The SD Model

7.1 Chapter Overview

This chapter provides functional descriptions of the SD User's Model, the SD Developer's Model, and the HDF file structures used to represent these models.



- Standard UML notation is used extensively in the formal data model descriptions. Section 7.2, "UML Notation and Object Symbols in HDF Data Model Descriptions," describes the relevant UML elements.
- Section 7.3, "Introduction to the SD Model," introduces the HDF SD model.
- Section 7.4, "The SD User's Model," and Section 7.5, "The SD Developer's Model," provide more details, introducing the SD User's Model as an intermediate step, and presenting the formal data model required to implement the SD Developer's Model.
- Section 7.6, "Mapping between SD Developer's Model and HDF File Structures," and Section 7.7, "SDS Memory Structures and Storage Layout," map the elements of the SD Developer's Model to HDF file structures and provide a detailed description of those memory structures and the storage layout in the file.
- Section 7.8, "Library Implementation Details with Example File and SDS," illustrates the HDF library implementation of the SD model.

7.2 UML Notation¹ and Object Symbols in HDF Data Model Descriptions

Many of the figures in this chapter and in Chapter 8, *General Raster Images: The GR Model*, employ UML notation (Unified Modeling Language notation) to show object relationships. The symbols and the relationships they describe are illustrated in Figure 7a. Note that UML can represent other objects and relationships as well; this discussion, Figure 7a, and Figure 7b present only what is required for this chapter.

FIGURE 7a

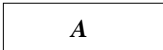
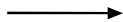
UML symbols and interpretations as used in formal HDF data model descriptions

An HDF object is represented as a rectangle.	
Associations or relationships among object instances are indicated by arrows.	
A diamond indicates the aggregation association, i.e., the <i>a part of</i> relationship.	

1. For a condensed description of UML, see *UML Distilled: Applying the Standard Object Modeling Language*, Martin Fowler with Kendall Scott, Addison-Wesley, 1997.

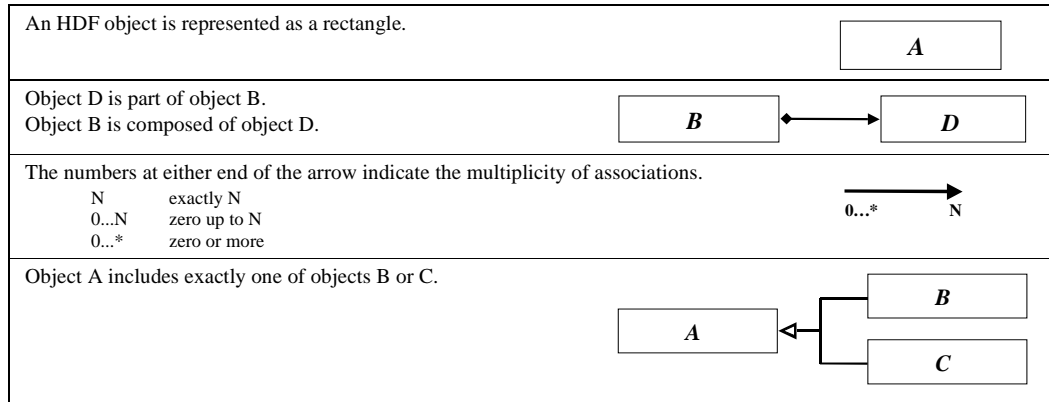

For example, the following statements describe the diagram at the right:

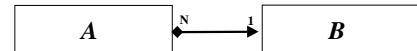

- Object A is composed of exactly one object B.
- Object B is associated with exactly N objects of type A.

The figures that make up the formal definition of the data model, such as Figure 7f, "SD User's Model -- The SD Model from the User's Point of View," or Figure 7h, "SD Developer's Model -- The SD Model from the Developer's Point of View," use the above UML notation rigorously.

Figures that are intended to informally illustrate points of discussion, such as Figure 7e, "A sample user's view of the SD model," or that illustrate the file layout, such as Figure 7o, "SDS View of the HDF File Structure," often use only a subset of the UML notation and treat the relationships less rigorously.

The formal data model discussions also include formal object descriptions clearly delineating the types of HDF objects and their attributes. The layout of these object descriptions is illustrated in Figure 7b.

FIGURE 7b

Formal object descriptions

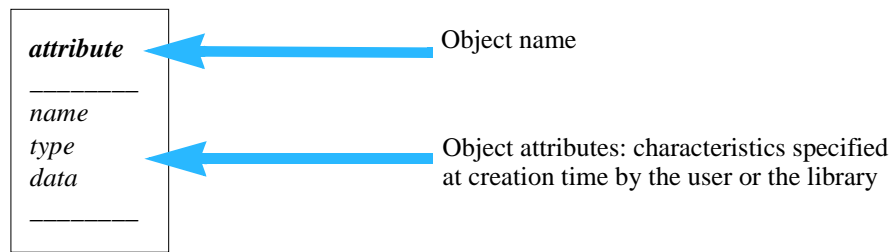

In object description figures, e.g. Figure 7i, "SD Developer's Model Objects," the top line specifies the name of the object. The entries immediately below the first horizontal bar list object attributes that are specified by either the user or the library when the object is created.

7.3 Introduction to the SD Model

An HDF file may contain many elements, including scientific data sets (SDSs, the subject of this chapter), general raster images (GRs), groups of HDF objects, images, palettes, annotations, etc. Figure 7c provides a high-level illustration of one potential HDF file.

FIGURE 7c

An HDF file may contain several objects and object collections

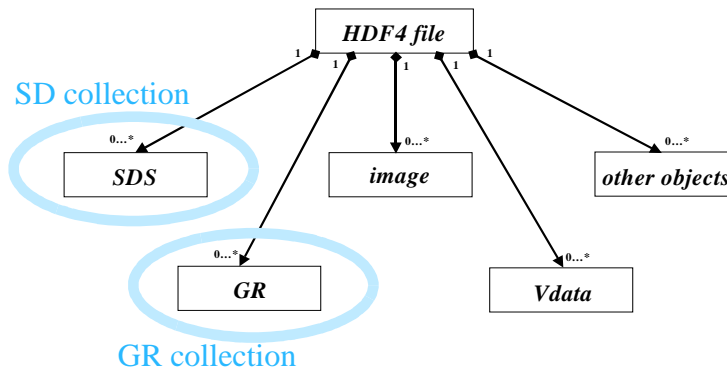

A scientific data set, or *SDS*, is an HDF data structure used to store a multidimensional array of scientific data and the supporting metadata. An SDS is stored in a group of HDF objects collectively known as an *SD collection*. A file may contain only one SD collection; an SD collection may contain several SDSs. Chapter 3, “Scientific Data Sets (SD API),” in the *HDF User's Guide* describes the SD model, in terms of required and optional components that comprise a scientific data set, and the *SD interface* routines provided by the HDF library to create and access SDSs in the file.

When a file is opened with the SD interface, also called the *SD API*, only the SD collection is available. A file opened with the SD interface should therefore be thought of in terms of Figure 7d. Other objects in the file are unavailable through the SD interface; they can, however, be accessed through other interfaces, e.g., the H, V, and SD interfaces.

FIGURE 7d

An HDF file opened with the SD interface

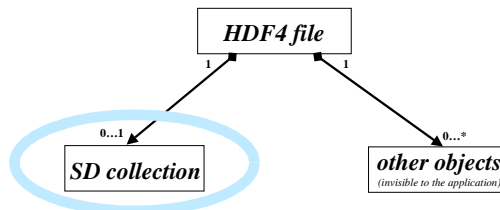

- When a file is opened with the SD interface, only the SD collection is available (circled above in blue; grey if medium is black-and-white). Other objects in the file are unavailable to the application.
- An SD collection may contain zero or more SDSs.

This chapter introduces two formal data models. The first version of the model, called the SD User's Model and illustrated in Figure 7f, formally describes the concepts introduced in Chapter 3 of the *HDF User's Guide*. The second model, called the SD Developer's Model or the Internal SD Model and illustrated in Figure 7h, is a generalization of the SD User's Model that reflects the technical implementation and the integration of the NetCDF data model into HDF. These models are described in Section 7.4, “The SD User's Model,” and Section 7.5, “The SD Developer's Model.”

Following the discussion of the data models, the mapping of the SD Developer's Model to HDF file structures is presented in Section 7.6, "Mapping between SD Developer's Model and HDF File Structures." Memory structures and storage layout are discussed in Section 7.7, "SDS Memory Structures and Storage Layout."

The last section, Section 7.8, "Library Implementation Details with Example File and SDS," offers an example of an HDF file containing an SD collection and describes the evolution of the file as different components of the SD collection and the SDS it contains are written to the file.

7.4 The SD User's Model

This section provides a logical description of an HDF file containing an SD collection. An example of a user's view of the data model is presented in Figure 7e; a formal graphical representation is presented in Figure 7f, "SD User's Model -- The SD Model from the User's Point of View."

From a user's point of view, an HDF file containing SDSs is structured as follows and as illustrated in Figure 7e:

- The file contains SDSs and possibly global attributes, which apply to all SDSs in the file.
- Each SDS may have associated attribute(s), dimension scale(s), and data.

An SDS is a multidimensional array of elements designed to store scientific data. Elements of the array may have one of the HDF predefined datatypes (see Section 5.5, "Scientific Data Sets," in this *HDF Specification and Developer's Guide*). **Spatial information** (*rank=N* and *dimension sizes*) describes the shape and the size of the array and is specified by the user. Each SDS is identified by a user-defined *name*. (If the user does not define a name, the HDF library will assign a default name at creation time.) An SDS always has a **storage layout** associated with it which is defined at creation time and describes how the SDS raw data is stored. Raw data storage options are contiguous (the default), external, chunked, compressed, chunked and compressed, and extendible. Name, spatial information, datatype, and storage layout are required components of an SDS. An SDS may optionally include raw data, denoted as *data* in the UML diagram (Figure 7f).

FIGURE 7e

A sample user's view of the SD model

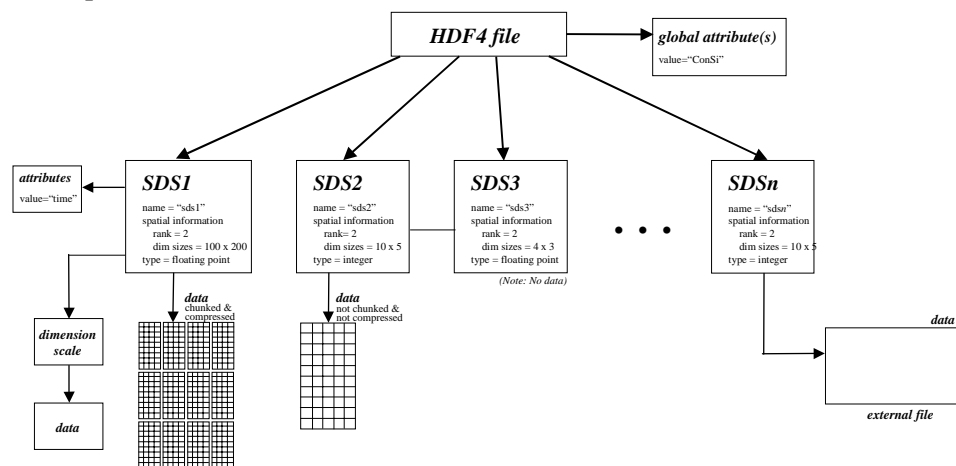

The Formal SD User's Model

The formal SD User's Model includes one type of object the user does not actually see, the **SD collection**. An HDF file may contain zero or one SD collection which may, in turn, contain zero or more SDSs. The **global attributes**, of which there may be zero or more, are actually associated

with the SD collection. Global attributes are optional, are defined by the user, and usually describe the intended usage of the SDSs in the file. The SDSs and the associated objects (see Figure 7f) are generally intended to be accessed only through the SD interface. When possible, however, the data sets are created to be readable via the older DFSD APIs.

An SDS may have zero or more associated *attributes*. These attributes are distinct from global attributes, which apply to all SDSs in the file.

The HDF library creates N *dimensions* associated with an SDS where N is the rank of the SDS. The library will assign a name to each dimension; if desired, these may be overwritten with user-defined names. Each dimension can be associated with more than one SDS. The size of the dimension is set up by the library, based on the SDS's spatial information. When a dimension is associated with more than with one SDS, it is called a *shared dimension*. Shared dimensions are created by the user.

Each dimension may have zero or more *dimension attributes*. Each dimension may also have data associated with it, in which case the data is called a *dimension scale* or *dimension variable*, as in netCDF.

FIGURE 7f

SD User's Model -- The SD Model from the User's Point of View

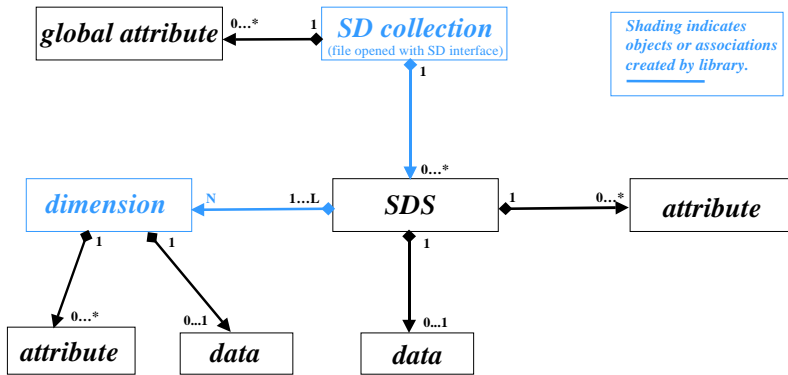

The formal model is based on relationships among user-specified objects of the SD User's Model and the associated object attributes, as described in Figure 7g.

FIGURE 7g

SD User's Model Objects

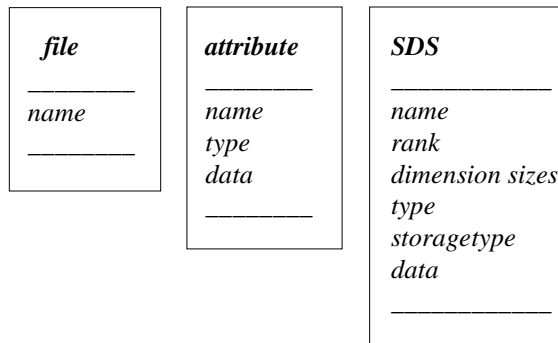

The SD interface provides routines to access the objects depicted in Figure 7e, "A sample user's view of the SD model." If an object is part of another object, it cannot be accessed by the SD interface without first accessing the enclosing object. E.g., dimension information can be accessed only after accessing the associated SDS.

7.5 The SD Developer's Model

SD User's Model focuses on aspects of data and relationships among objects that facilitate the user's scientific work. Since the library must translate that data into something that can be stored to and retrieved from the file in an efficient, universally-accessible manner, the SD Developer's Model presents a slightly modified set of objects and relationships.

While the SD collection is a virtual object in the user's model and the user never sees it or has any practical means of perceiving it, the SD collection is a very real object in the developer's model. Different kinds of objects from the user's model are generalized as a simple type of object in the developer's model and some object relationships become more generalized.

As one can see in the UML diagram in Figure 7f, the *dimension-data-attribute* association is very similar to the *SDS-data-attribute* association. This leads to the generalized UML diagram in Figure 7h, called the SD Developer's Model or the Internal SD Model. In this diagram, *SDS* and dimension scales are replaced by a *variable*. The dimension object associated with the variable describes the spatial information of the corresponding variable (i.e., the corresponding SDS or dimension scale) and is independently a part of the SD collection.

Less formally expressed, when an attribute is assigned to the dimension, or data is associated with the dimension, the HDF library creates internal structures in which to store this information. These structures are the same as for an SDS. See Section 7.6, "Mapping between SD Developer's Model and HDF File Structures," for further discussion. The HDF library uses the terminology "*a dimension is promoted to an SDS*" and that promotion is transparent to the user. The user still accesses a dimension's data and dimension attributes via the SD interface routines and the SDS to which that dimension belongs.

Since a dimension scale is stored in the same type of HDF object as an SDS, there is no difference between them from the HDF library's (and hence the developer's) point of view. A dimension is simply a special case of the more general SDS and both objects are viewed by the library and the developer as *variables*. In the user's view, an SDS can have associated attribute(s), data, and dimension(s) and a dimension can have associated attribute(s) and data. Therefore, in the developer's view, a variable can have associated attribute(s), data, and dimension(s)

FIGURE 7h

SD Developer's Model -- The SD Model from the Developer's Point of View

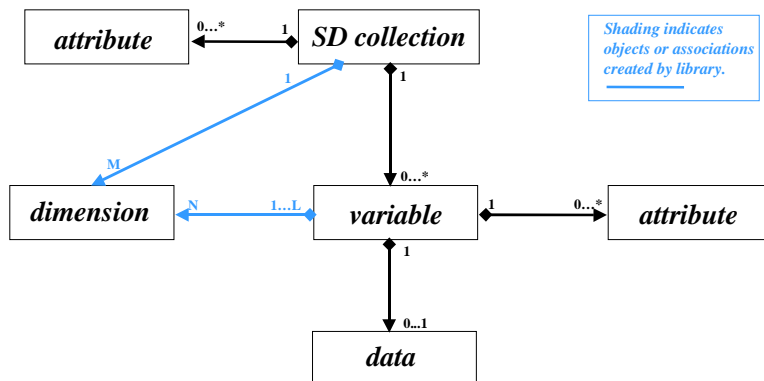

- *variable* can be either an SDS or a dimension scale.
- *N* is a rank of the variable.
- *L* is 1 if *variable* is a dimension scale.
- Neither the link from *SD_collection* to *dimension* nor the link from *variable* to *dimension* is available through the SD interface, though they are available via other HDF interfaces.

Each object in Figure 7h is represented by a set of HDF objects in the file as defined in Section 7.6, "Mapping between SD Developer's Model and HDF File Structures."

The SD collection is created automatically by the HDF library. The attributes, variables, and data are created by the user via the SD interface.

Figure 7i summarizes the data and metadata associated with each SD model object.

FIGURE 7i

SD Developer's Model Objects

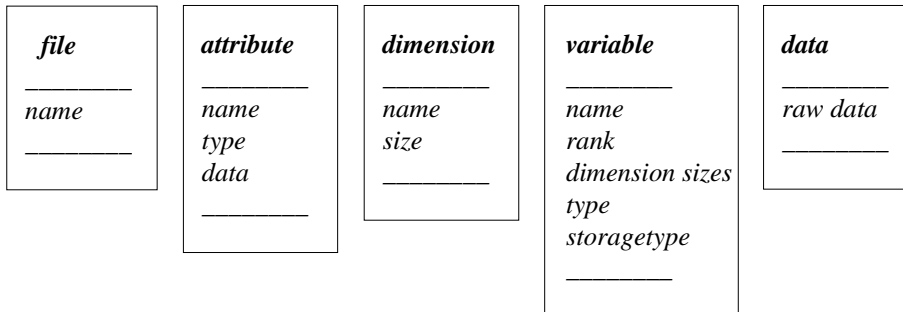

A *variable* is an array structure that has a name, spatial information (rank and dimension sizes), datatype, and storage layout type and represents either an *SDS* or a *dimension variable*. The difference between two objects is in their rank and storage layout. The *rank* of a dimensional variable is always 1 and its *storage layout type* can be contiguous or extendible (unlimited). See Table 7a for a list of storage layout options.

A *variable* always has *N* associated *dimensions* with it. If *variable* is a dimension variable, then the multiplicity factor *N* is 1. A *variable* may have zero or more *attribute* objects associated with it.

TABLE 7a

SDS Storage layouts

variable						
SDS					dimension variable	
special storage						
contiguous	chunked	compressed	chunked and compressed	external	default	extendible

- Contiguous storage is the default layout and requires no special storage tag.





7.6 Mapping between SD Developer's Model and HDF File Structures

This section describes the mapping between the objects represented in the UML diagram in Figure 7h, "SD Developer's Model -- The SD Model from the Developer's Point of View," and the HDF objects in the file.

The illustrations in this section employ the symbols in Figure 7j to identify the indicated file structures.

FIGURE 7j

File structure symbols

Vgroup		HDF element identified with tag/ref pair	
Vdata		Abstract SD model object	

7.6.1 SD Collection

SD_collection, which is the view of the file as revealed by the SD interface, is mapped to an HDF Vgroup with name=*file_name* and class=CDF0.0. For purposes of this discussion only and to distinguish this Vgroup from other Vgroups in the discussion, this is referred to as the *top Vgroup* in the file. All objects shown in Figure 7h, "SD Developer's Model -- The SD Model from the Developer's Point of View," are mapped to the HDF objects which are members of this top Vgroup, as illustrated in Figure 7k through Figure 7p.

FIGURE 7k

Model-to-File Mapping -- *SD_collection*



Note that at the user level, the SD collection is a virtual entity; it has no real existence for the user. At the developer level and in the file, however, the SD collection is a real object corresponding to the top Vgroup. All of the HDF file structures that make up the SD collection are gathered together into this Vgroup.

7.6.2 Attribute

An *attribute* is mapped to the Vdata as follows:

- The Vdata has the name=*attribute_name* and the class=Attr0.0.
- The Vdata has only one field with the name [*Values*].
- For numerical attributes:
 - The order of the field is 1 for a numerical attribute
 - The data type of the field is the same as that of *attribute*.
 - The Vdata has *N* records, where *N* is the number of attribute values.
- For character attributes:
 - The order of the field is *N*, where *N* is the number of characters.
 - The data type of the field is the same as that of *attribute*.
 - The Vdata has exactly one record.
- If *attribute* is attached to the file, then the corresponding Vdata will be a member of the top Vgroup. If *attribute* is attached to the variable (an SDS or a dimensional scale), then the Vdata is a member of the variable Vgroup. (See Section 7.6.3, "Variable.")

FIGURE 7l

Model-to-File Mapping -- *attribute*



7.6.3 Variable

A *variable* is mapped to a *variable Vgroup* with name=variable_name and class=Var0.0. All variable Vgroups are members of the top Vgroup. A Vgroup that represents a *variable* has as members *N* Vgroups which represent *dimensions*, and where *N* is the rank of *variable*.

FIGURE 7m

Model-to-File Mapping -- variable, data, and attribute

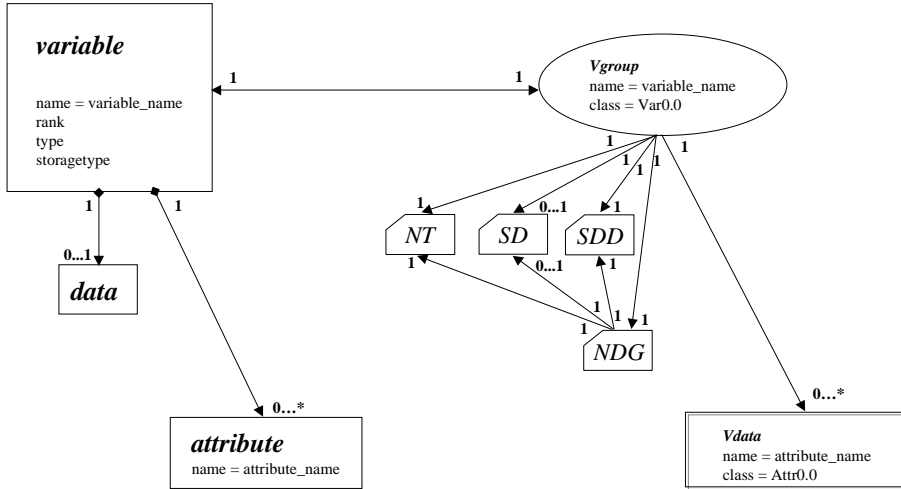

In Figure 7m, note that *NT*, *SD*, *SDD*, and *NDG* are discrete and identifiable objects in an HDF file and are accessible via the **H** interface. In this figure, the variable's rank is stored in *SDD*, the storage type in *NT*, the data in *SD*, and the attribute in the *Vdata*. *NDG* exists to enable backward compatibility with the DFSD interface.

For a more complete discussion of the *SDD*, *NT*, *SD* and *NDG* structures, see Chapter 9, *Tag Specifications*. *DFTAG_SDD*, *DFTAG_SD*, and *DFTAG_NDG* are discussed in Section 9.3.7, "Scientific Data Set Tags." *DFTAG_NT* is discussed in Section 9.3.1, "Utility Tags."

7.6.4 Dimension

A *dimension* is mapped to the following group of HDF objects:

- The Vgroup with the name of *dimension_name* and class of (U)Dim0.0. The U indicates that this is an unlimited dimension; otherwise the order of the dimension would be fixed.
- A Vdata within this Vgroup with the name *dimension_name* and class DimVal0.0 or DimVal0.1. (See Figure 7n).
 - Note the two possible classes. This is a versioning mechanism sometimes used within the HDF library to identify internal technical changes. In this case, DimVal0.0 identifies a dimension created under the original approach while DimVal0.1 identifies a dimension created under a subsequent revision.
 - If the class is DimVal0.1, the default behavior is that the Vdata has one integer field (int32) of order 1 and contains only one record with the size of the dimension. If the user has explicitly created/stored dimension information, then the Vdata will be of size k, as described in the following DimVal0.0 bullet.
 - If the class is DimVal0.0, the Vdata will have k records, where k is the size of the dimension and the default value of each record equals the record's position in the Vdata.

- The *dimension Vgroup* representing *dimension* is a member of the *variable Vgroup* representing *variable* (see Figure 7o).
- If *dimension* is shared, then the dimension Vgroup can be a member of more than one variable Vgroup.

FIGURE 7n

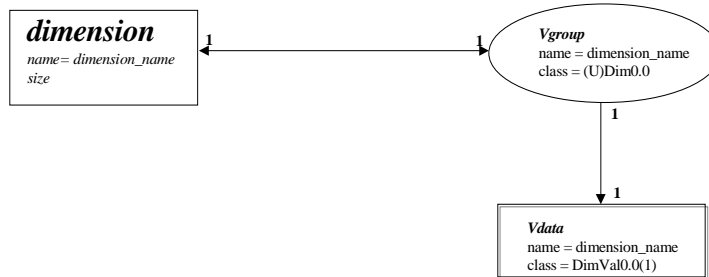
Model-to-File mapping - dimension

As illustrated in Figure 7n, the dimension value is stored in the Vdata with name=dimension_name, which is itself a member of the Vgroup with name=dimension_name.

7.6.5 Overall Correspondence of SDS Elements and the HDF File Structure

The aggregation of the preceding elements and relationships, at the HDF file structure level, is summarized in Figure 7o.

FIGURE 7o

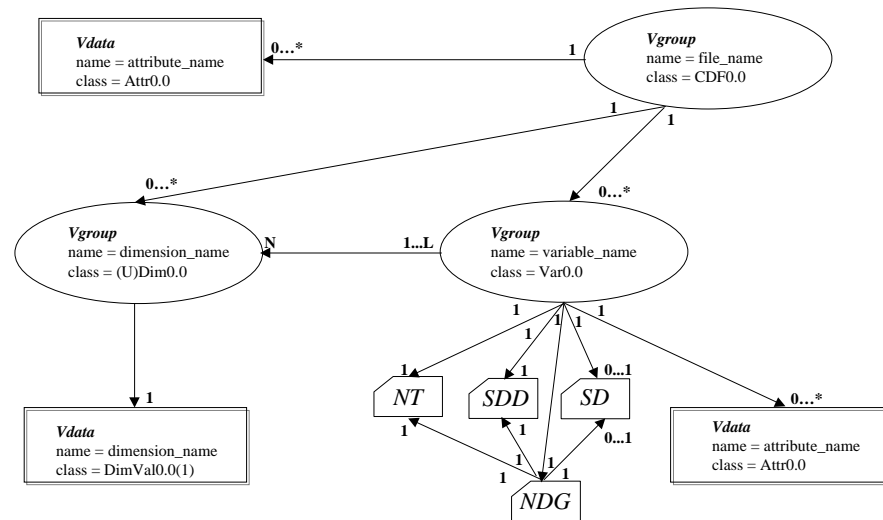
SDS View of the HDF File Structure

Note the correspondence between the elements of the SDS view of the HDF file structure, as illustrated in Figure 7o, and the SD Developer's Model, as illustrated in Figure 7h. This correspondence is illustrated in Figure 7p.

- The SD collection is represented by a Vgroup, the top Vgroup.
- Each variable, which can be either an SDS or a dimension scale, is represented by a variable Vgroup which is a member of the top Vgroup.
- Dimensions and attributes are represented by Vgroups and Vdatas, respectively, which are members of the SDS's variable Vgroup.

- The raw data, data types, storage layout, and specialized information used by the library are represented by low-level tag/ref elements which are members of the variable Vgroup.
- A dimension attribute is represented by a Vdata which is a member of a dimension scale's variable Vgroup.

The HDF SDS file structures are illustrated by the background elements (black) of Figure 7p. The foreground elements (blue or gray, depending on whether this is viewed in color or black-and-white) show the relationship between the SD Developer's Model and the HDF SDS file structures. Note that Vgroups and Vdatas play several different roles in this scheme; the roles of individual Vgroups and Vdatas are indicated by their class.

FIGURE 7p

Developer's view of the SD model (Figure 7h) and the corresponding elements of the HDF file structure (Figure 7o)

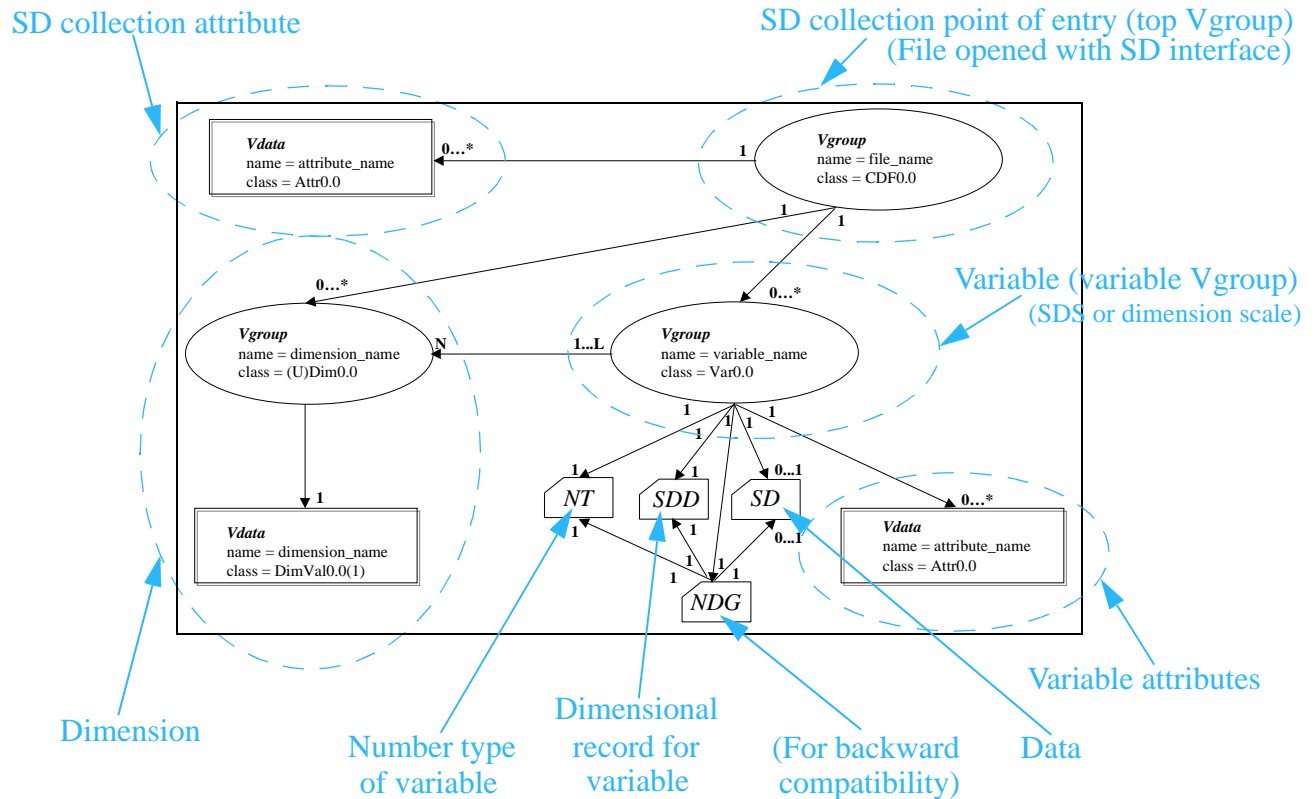

7.6.6 Accessing SD Objects via non-SD Interfaces

The SD interface is the only HDF interface that carefully maintains objects, file structures, and the relationships among them to ensure the integrity of scientific data sets. While all elements of an SD collection are individually accessible and manipulatable via the more general HDF interfaces, such as the H interface, to do so introduces a significant risk of corrupting relationships and/or data within the SD collection and is *not* recommended.

7.7 SDS Memory Structures and Storage Layout

The preceding sections of this chapter have focused on SD model objects and HDF file structures. With this section and the next, the focus shifts to the HDF library implementation of the SD models, including an extensive discussion of the memory structures employed.

The file data structures in which the objects of the SD models are stored are mapped by the library to data structures in memory either when an HDF file is opened with the SD interface or as the objects are created during execution. The UML diagram in Figure 7q illustrates this mapping.

FIGURE 7q

File Structures to Memory Structures Mapping

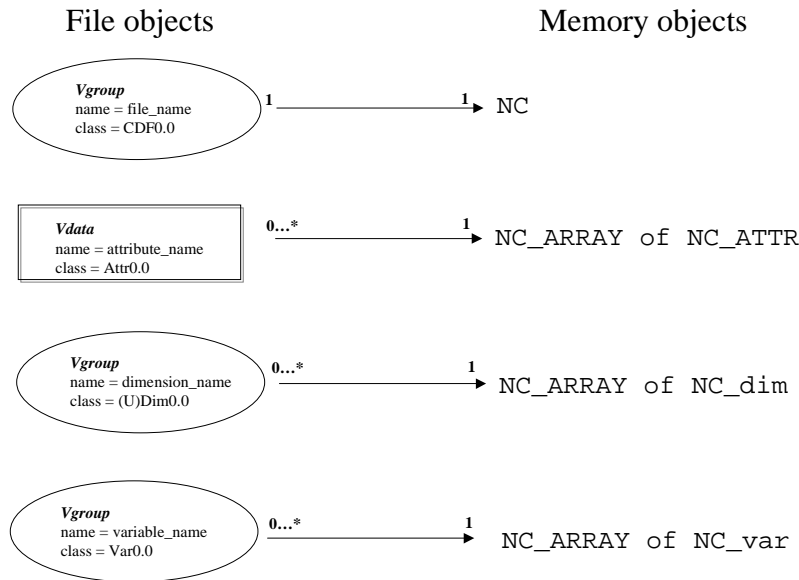

These memory structures, *NC*, *NC_ATTR*, *NC_ARRAY*, *NC_var* and *NC_dim*, are described in detail in Section 7.8, "Library Implementation Details with Example File and SDS." The HDF file structures are mapped to the memory structures as follows:

- The top Vgroup, the Vgroup containing all elements of the SD collection, is mapped to the *NC* memory structure.
- Vdatas, containing data array attributes or dimension attributes, are mapped to the *NC_ARRAY* of *NC_ATTR* memory structure.
- Dimension Vgroups, each containing the elements of a dimension, are mapped to the *NC_ARRAY* of *NC_dim* memory structure.
- Variable Vgroups, each containing the elements of an SDS, are mapped to the *NC_ARRAY* of *NC_var* memory structure.

FIGURE 7r

Data structures for HDF file contents

NC

```

char path[FILENAME_MAX + 1]
unsigned flags
XDR *xdrs
long begin_rec - position of the first 'record'
unsigned long recsize - length of 'record'
int redefid ;
/* below gets xdr'd */
unsigned long numrecs - # of 'records' allocated
NC_array *dims
NC_array *attrs
NC_array *vars
int32 hdf_file;
int file_type;
int32 vgid;
int hdf_mode - mode attached for
hdf_file_t cdf_fp - file ptr for CDF files

```

NC_array

```

nc_type type
size_t len - total length originally allocated
size_t szof - size of each value
unsigned count - length of the array
Void *values - the actual data

```

NC_dim

```

NC_string *name
long size
int32 dim00_compat - compatible w/ Dim0.0
int32 vgid - vg of this dim
int32 count - # of pointers to this dim

```

NC_attr

```

NC_string *name
NC_array *data
int32 HDFtype

```

NC_var

```

NC_string *name
NC_iarray *assoc - user definition
unsigned long *shape - compiled info?
unsigned long *dsizes - compiled info?
NC_array *attrs
nc_type type - the discriminant?
unsigned long len - total length originally alloc?
size_t szof - sizeof each value
long begin - seek index, often an off_t
NC *cdf - the file which this var belongs to
int32 vgid - id of the variable's vgroup
uint16 data_ref - ref of var's data storage (if
exists, 0 otherwise)
uint16 data_tag - tag of var's data storage (if
exists)
uint16 ndg_ref - ref of ndg for this dataset
intn data_offset - non-traditional data may not
begin at 0
int32 block_size - size of the blocks for
unlimited dim. datasets
int numrecs - # of records this has been filled
int32 aid - aid for DFTAG_SD data
int32 HDFtype - type of this var as HDF thinks
int32 HDFsize - size of this var as HDF thinks
int32 is_ragged - this is a ragged array
int32 * rag_list - size of ragged array lines
int32 rag_fill - last line in rag_list to be set
vix_t * vixHead - list of VXR records for
CDF data storage

```

NC_iarray

```

(counted array of ints for assoc list)
unsigned count
int *values

```

NC_string

```

unsigned count
unsigned len
uint32 hash
char *values

```

7.8 Library Implementation Details with Example File and SDS

This section describes the interface routines that are used to create, open, and modify an SDS and its components in the file. In particular, the following evolutionary stages of accessing and manipulating the SDS are discussed:

- The file is created or open.
- An SDS is created.
- Data is written to the SDS.
- Global attributes are set for the file.
- Local attributes are set for the SDS (data string and attribute name) and the dimension (dimension scale and dimension string).
- Access to the file is terminated.

At each stage, the correspondence between storing the contents in memory and representing the data in the file is discussed.

Illustrations in this section adhere to the conventions used previously in this chapter, with the following additional elements:

- New items introduced for the next step are lightly shaded.
- Items being removed are heavily shaded and/or labeled in white text.

7.8.1 Creating or opening an HDF file

The routine **SDstart** creates a new HDF file or opens an existing one.

- When **SDstart** creates a file, a structure *NC* is created with the pointers *dims*, *attrs*, and *vars* set to NULL.
- When **SDstart** opens a file, a structure *NC* is created and the structures *NC_array*, *NC_var*, *NC_dim*, and *NC_attr* are created and attached to the pointers *vars*, *dims*, and *attrs* corresponding to the contents of the file.

The objects are stored in these internal data structures (except for writing values) until the completion of **SDend**, which writes the contents in these data structures to the file in the form of Vgroups, Vdatas, and other objects, as described below in each stage of the file evolution.

7.8.2 Creating an empty SDS

The routine **SDcreate** creates an SDS by the following steps:

- Creates an *NC_dim* for each dimension then inserts it into *NC_array* pointed to by *dims*. If *dims* is NULL, a structure of *NC_array* is created for it.
- For each *NC_dim*, creates a structure of *NC_string* to hold the name of the dimension.
- Creates an *NC_var* then inserts it into *NC_array* pointed to by *vars*. If *vars* is NULL, a structure of *NC_array* is created for it.
- Creates a structure of *NC_string* to hold the name of the SDS.
- Creates a structure of *NC_iarray* to hold the indices of the SDS dimensions.

Figure 7s illustrates the contents of the SD collection in the HDF file in memory at this point, when the collection contains an empty two-dimensional SDS.

FIGURE 7s

SD collection contents in memory after a 2-dimensional SDS is created

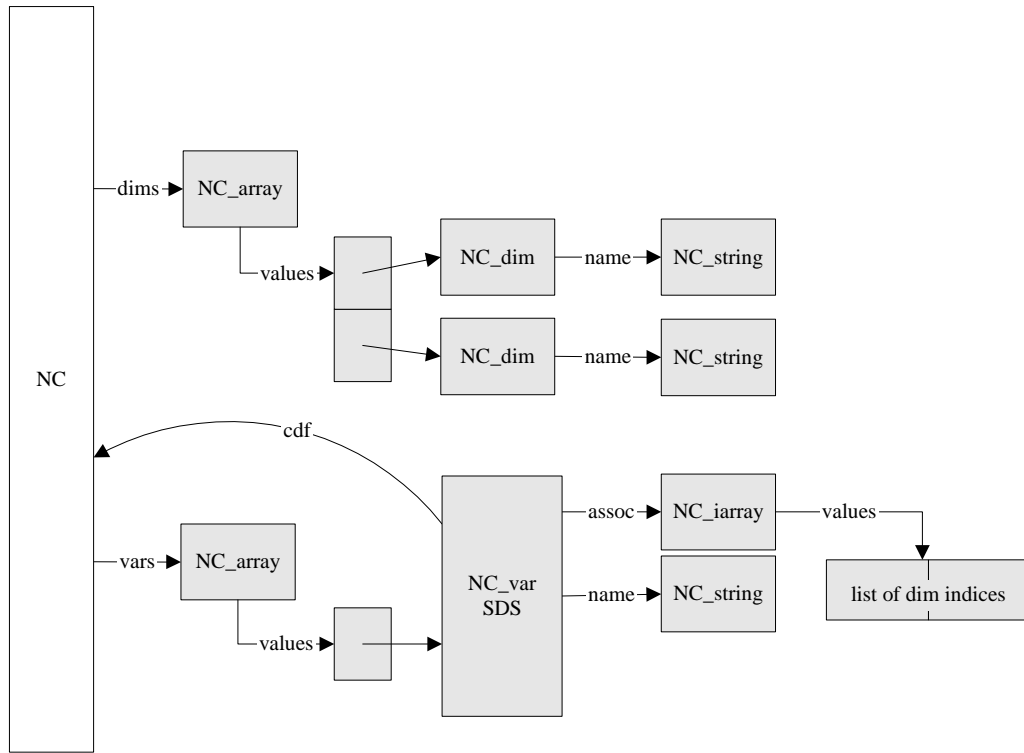
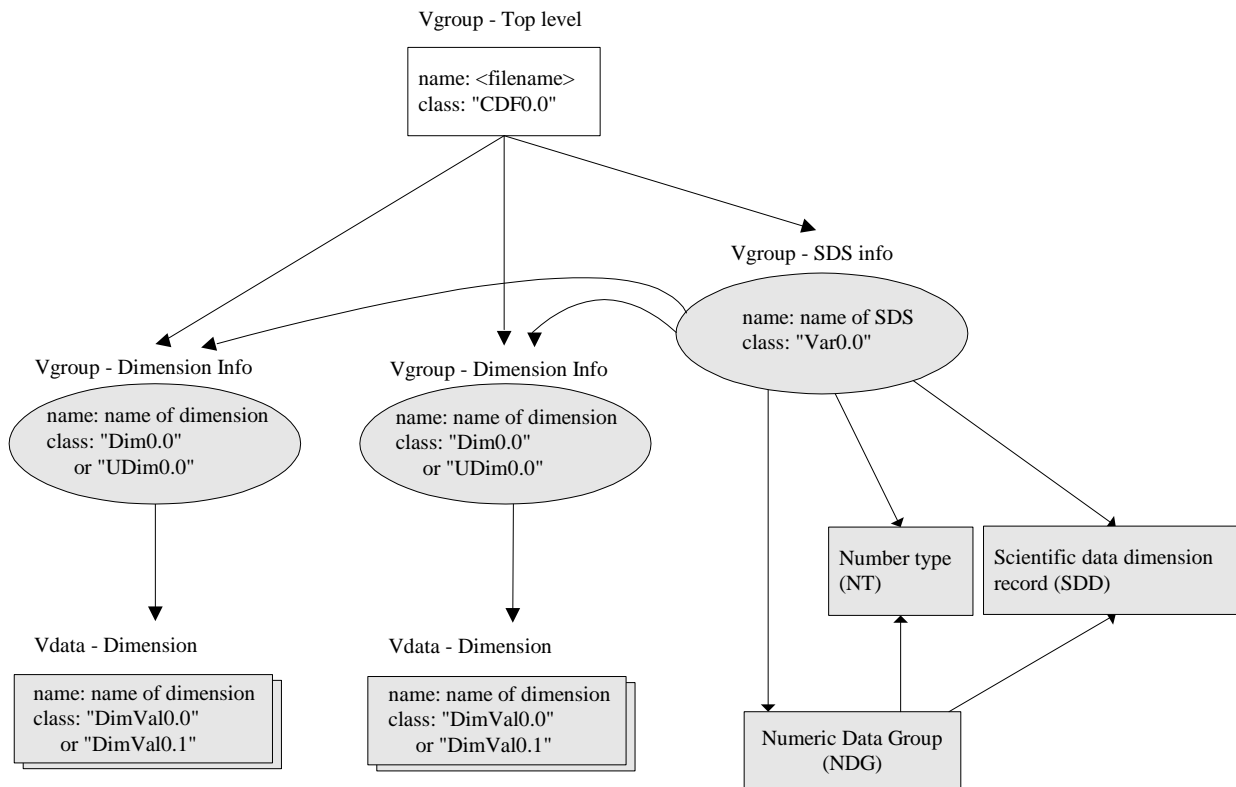

Figure 7t illustrates the corresponding representation in the file of the contents of the SD collection after the access to the file is terminated, i.e., **SDend** is called. Refer to Section 7.8.9, "Terminating access to the SD collection and file," for the description of the termination process carried out by this routine. In Figure 7t, a Vgroup at the top level represents the SD collection and contains three other Vgroups. The first two second-level Vgroups represent the two dimensions of the SDS. Each of these dimension Vgroups includes a one-field Vdata that has one record storing the size of the dimension. The third second-level Vgroup represents the SDS. This Vgroup includes several low-level objects, which have been described earlier in the chapter (see Section 7.6.3, "Variable"):

- NT, SDD, NDG, and SD (introduced in Figure 7u) are tag/ref objects.
 - NT, the number type of the SDS, is identified by the tag `DFTAG_NT`.
 - SDD, the scientific data dimension, is identified by the tag `DFTAG_SDD`.
 - NDG, the numeric data group, is identified by the tag `DFTAG_NDG`.
 - SD, the scientific data, is identified by the tag `DFTAG_SD`. SD is present only after data has been written to the SDS.
- NT contains a number type definition which can be used by different data objects.
- NDG contains two pointers, one to the NT and one to the SDD. The NDG is included solely to enable backward compatibility with earlier versions of HDF.

FIGURE 7t

SD collection contents in the file with a 2-dimensional empty SDS



7.8.3 Writing data to an SDS

The routine **SDwritedata** writes data to an SDS. Since the writes are directly to the file, no new internal data structures are introduced. The writing process includes searching the Vgroup that holds the SDS information for the SD object (tag `DEFTAG_SD`). If this object is not found among the elements of the SDS information Vgroup, i.e., data has never been written to this SDS, a new reference number is assigned for the SD object. This new object is then added to the SDS. The reference number of this new object is stored in `(NC_var)->data_ref`.

Figure 7u shows the change in the contents of the SD collection in the file after the SDS is written with data. A new object is added to the SDS Vgroup.

FIGURE 7u

SD collection contents in the file after a 2-dimensional SDS is written

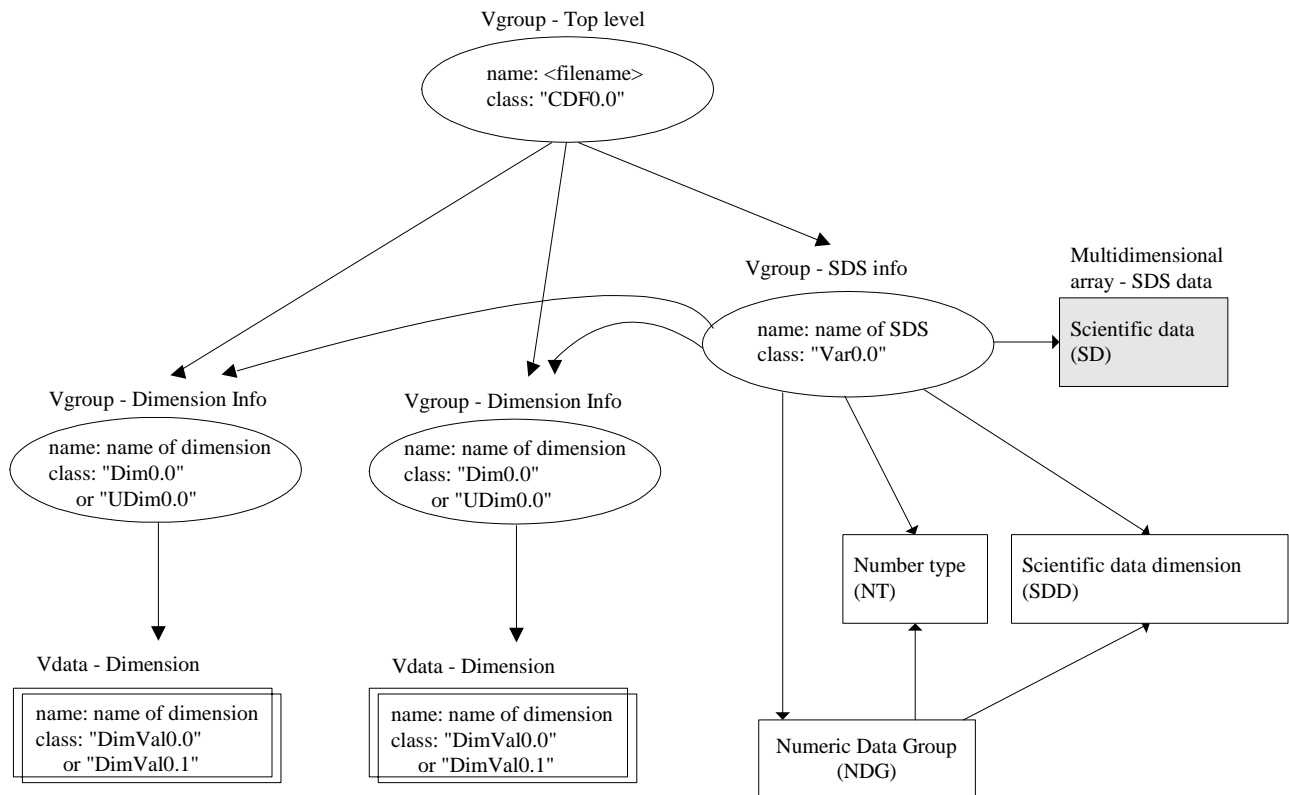

When more than one SDS is created, the process of writing to the file is the same as when only one SDS is created. The dimensions, variable record, and attributes of the succeeding SDSs are added to the pointer `(NC)->dims`, `(NC)->vars`, and `(NC)->attrs` and are written to the file in the same manner as for the first SDS.

If a storage layout is specified for the SDS (e.g., compression, chunking, or external storage), then the SD tag is promoted to a special tag, as described in Chapter 10, *Extended Tags and Special Elements*.

7.8.4 Adding global and local attributes

The routine **SDsetattr** adds an attribute to

A: the SD collection by the following steps:

Creates an *NC_attr* for the attribute.

Attaches the new attribute record to the pointer values of *NC_array* pointed to by *attrs*. If *attrs* is NULL, a structure of *NC_array* is created for it first.

B: an SDS by the following steps:

Creates an *NC_attr* for the attribute.

If this object has not yet had any attribute created, i.e., *attrs* is NULL, starts the attribute list by creating a structure of *NC_array*, then attaches the new attribute record to the pointer values of *NC_array*.

If this object already has an attribute list, searches the attribute list for an attribute with the same name as the one to be added.

- If one is found, replaces the found attribute structure with the new one.
- If none is found, adds the new attribute structure to the attribute list. Note: the number of attributes must not exceed the maximum number of attributes allowed (*MAX_NC_ATTRS*.)

C: a dimension by the following steps:

- Creates an *NC_attr* for the attribute
- If the SD collection contains no variable record (from the list *(NC)->vars*) that represents this dimension, promotes the dimension to a variable record, i.e. creates an *NC_var* for this dimension and attaches it to the variable list of the SD collection, *(NC)->vars*. At this point, the dimension has a variable record and, therefore, the rest of the attribute-setting process is identical to the process for an SDS.

Figure 7v, below, Figure 7w on page 74, and Figure 7x on page 75 illustrate the changes in the data structures as a global SDS attribute, an SDS attribute, and a dimension attribute are added, respectively.

FIGURE 7v

SD collection contents in memory after adding a global attribute

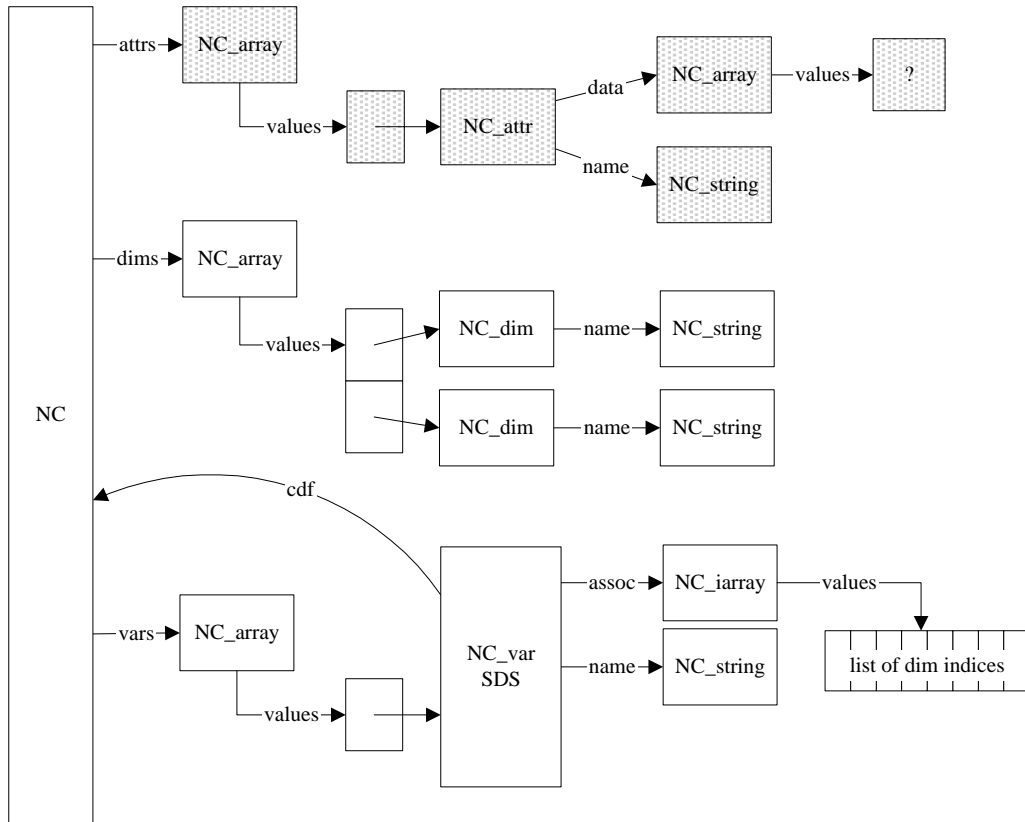

FIGURE 7w

SD collection contents in memory after adding an SDS attribute

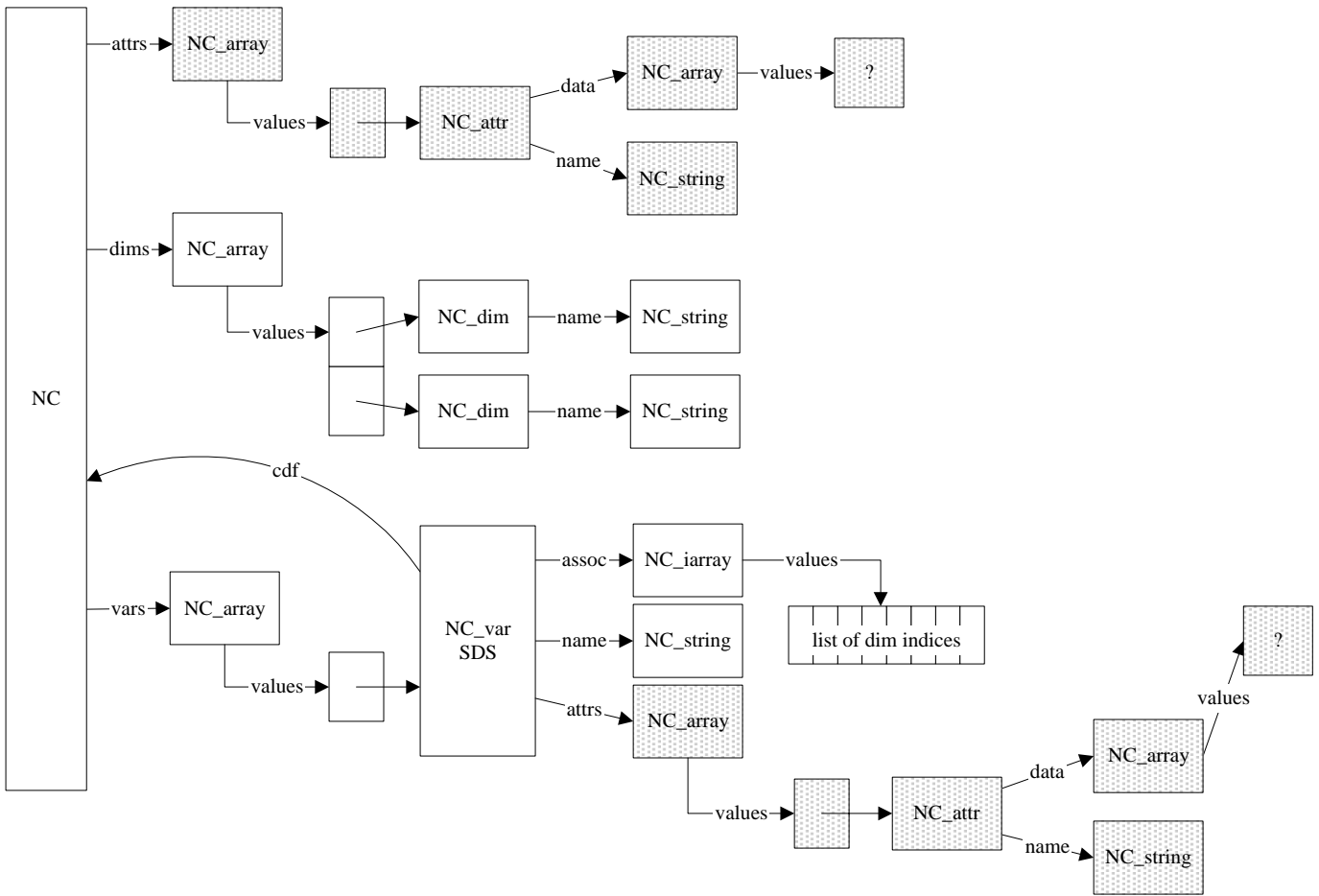
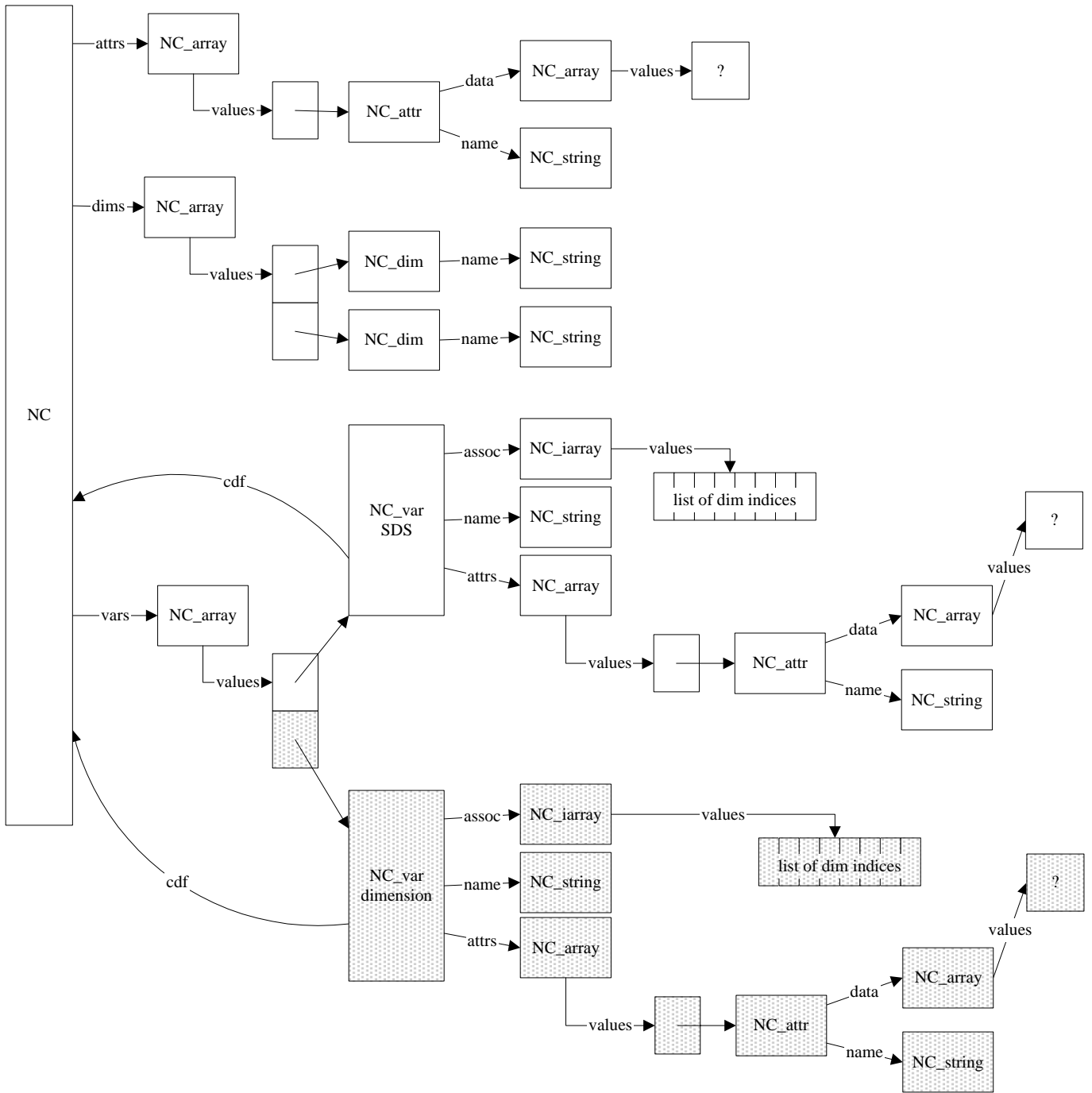
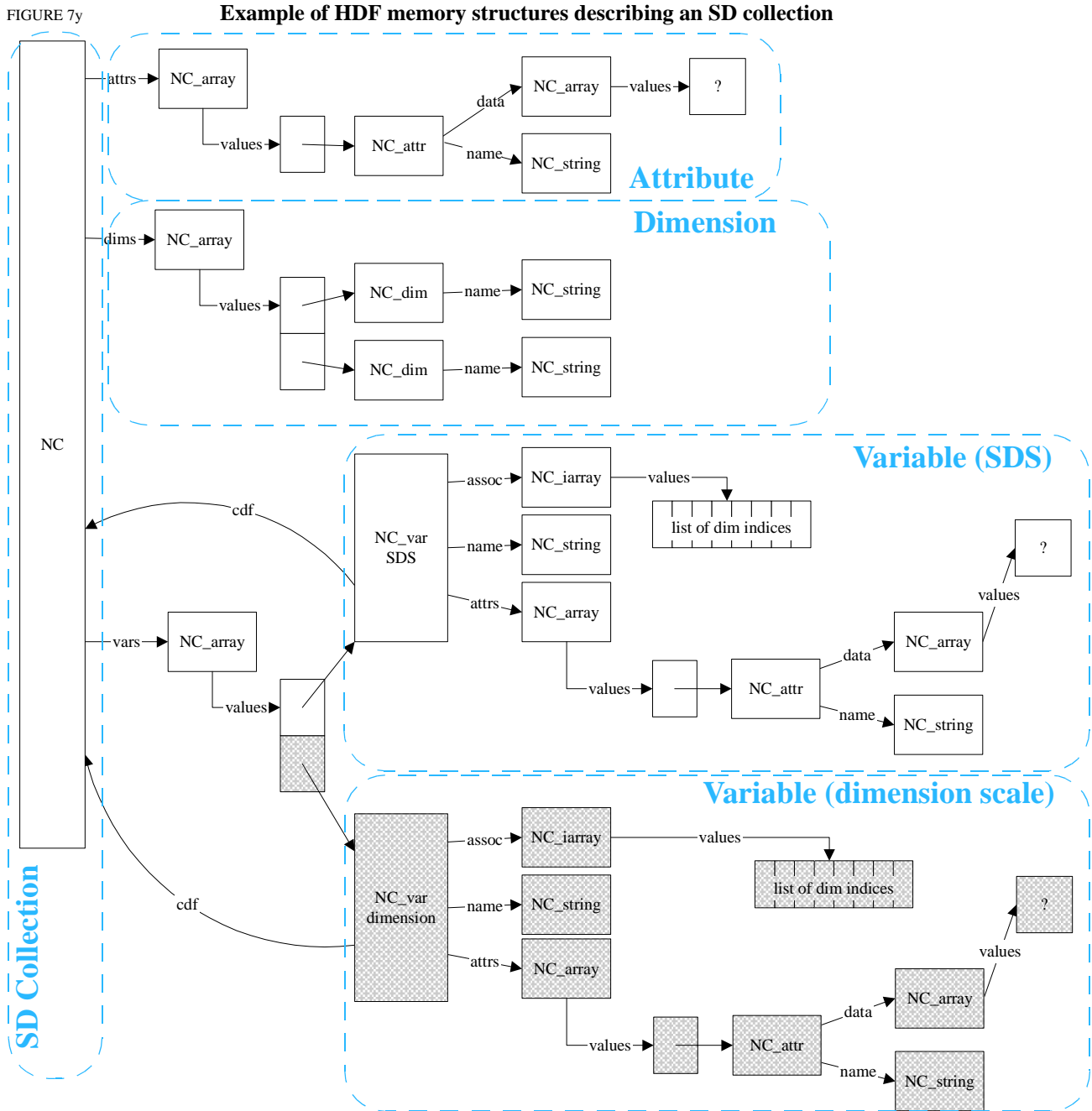

FIGURE 7x

SD collection contents in memory after adding a dimension attribute



It is worthwhile to pause at this point and review Figure 7y which highlights the relationship of the memory structures that have been built up by the library to the elements of the SD model discussed earlier in this chapter.



If **SDend** is called after adding the preceding elements, Figure 7z illustrates the representation of the SD collection in the closed and written file. The top level Vgroup, the SDS Vgroup, and one of the dimension Vgroups now each has another element, a Vdata, that holds its newly added attribute. Each attribute is stored in a one-field Vdata that has one record containing the attribute values. The Vdata's order is the number of values in the attribute.

FIGURE 7z

SD collection contents in the file after adding a global attribute, an SDS attribute, and a dimension attribute

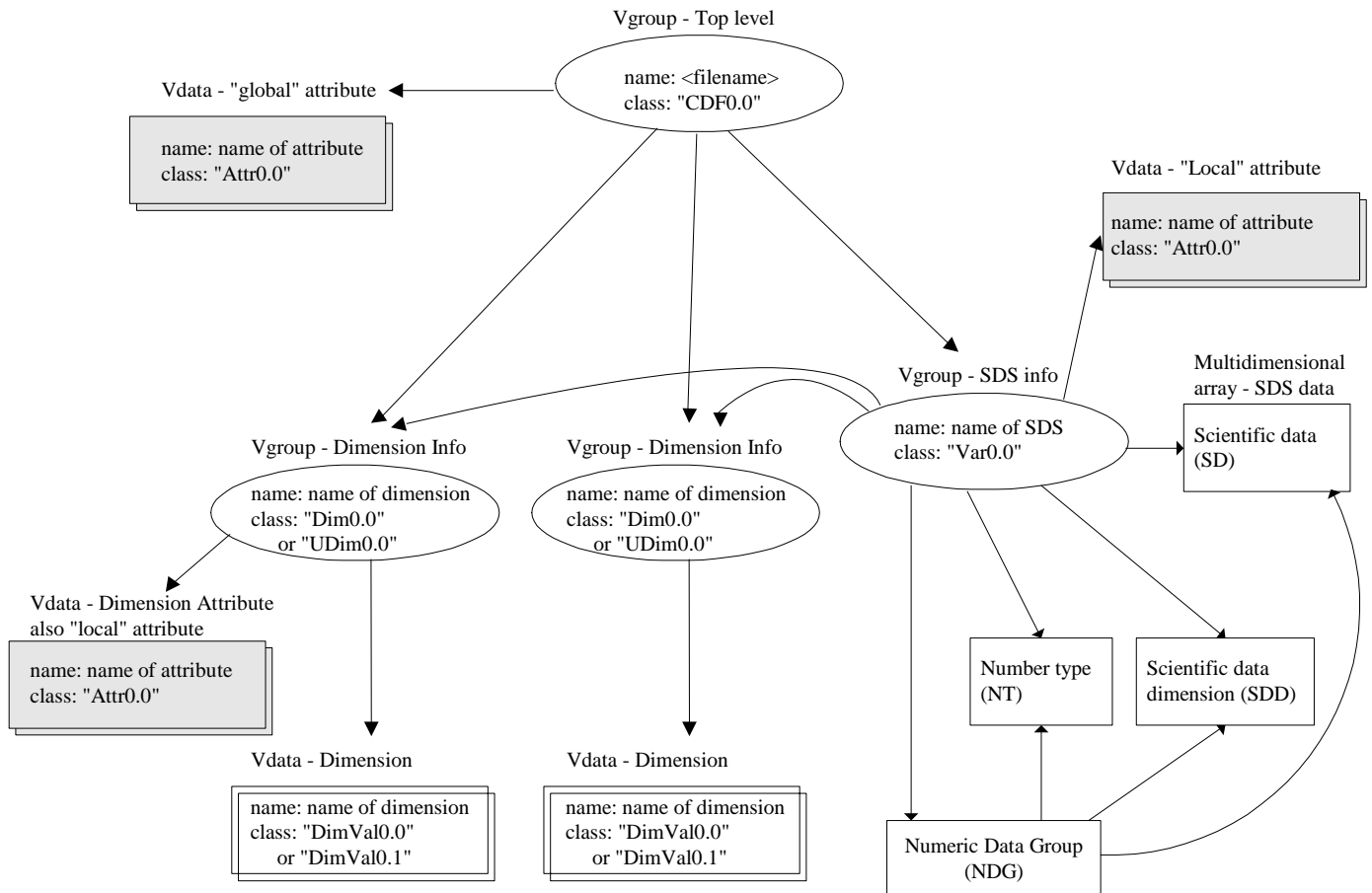

7.8.5 Setting a data string

The routine **SDsetdatastrs** sets values for the pre-defined attributes label, unit, format, and coordinate system. The process of setting each of these attributes is similar to that of setting a user-defined attribute, as described in Section 7.8.4, "Adding global and local attributes," except that the names of these attributes are pre-defined rather than being set by the user.

7.8.6 Setting a dimension name

Figure 7aa shows the dimension list attached to the SD collection structure in a simplified diagram so that the following illustrations will be easy to describe and understand. In this figure, there are four dimensions named as *fakeDimn* by default, where *n* is the index of the dimensions as they are created.

FIGURE 7aa

Structures of the dimension list (example)

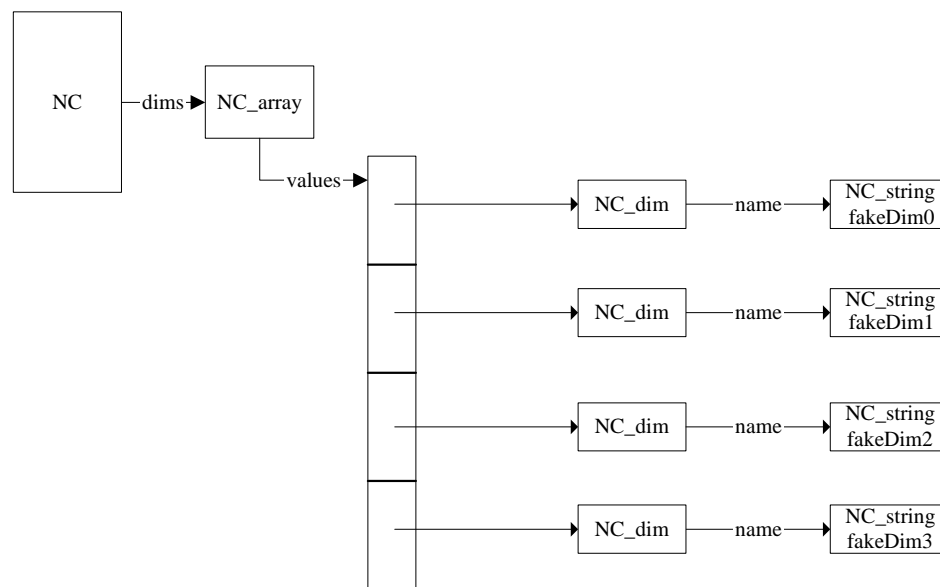

The routine **SDsetdimname** sets the name for a given dimension according to the following criteria:

- If a dimension already exists having the same name as the name being set but having a size different from that of the given dimension, **SDsetdimname** fails.
- If no dimension with the given name exists, a new name structure is created and the dimension is set to the new name. The structure holding the dimension's old name, which can be a default name or one that was previously set, will be removed. Figure 7ab on page 79 shows the dimension *fakeDim2* renamed to *dimname*.
- If a dimension already exists having the same name as the name being set and having the same size as the dimension being set, the found dimension structure (*NC_dim*) will be used for the dimension being set as well. Figure 7ac on page 79 illustrates this event. Let's say that we are setting *name* for the dimension *fakeDim3* to a name, *dim_name*, that is the same as that of the third dimension. When the matched dimension is found, all pointers to the dimension being named are reset to point to the dimension *dim_name*. The old structure and its elements are then removed.

At this point, the SD collection illustrated in Figure 7s on page 69 and Figure 7t is considered completely evolved. The dimension settings are described in detail in Figure 7aa, Figure 7ab, and Figure 7ac.

FIGURE 7ab

Setting a dimension name to a new name

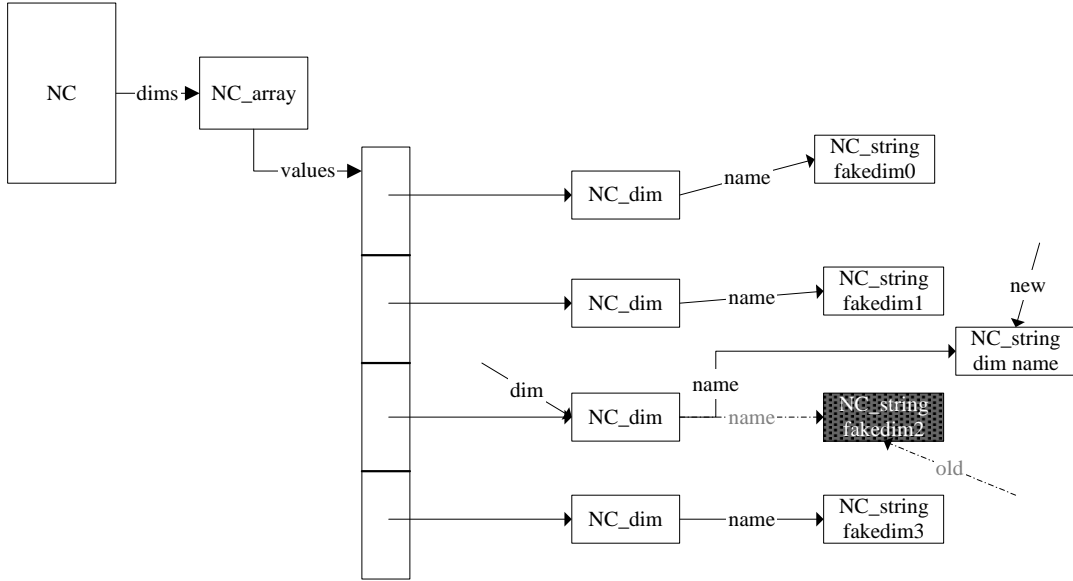
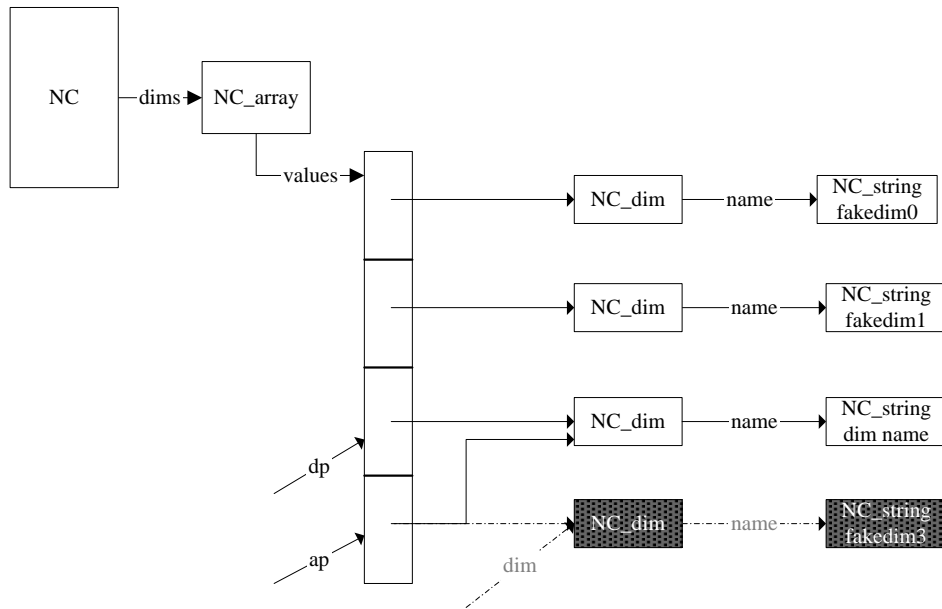

FIGURE 7ac

Setting a dimension name to an existing name



7.8.7 Setting a dimension scale

The routine **SDsetdimscale** sets values to a given dimension as follows.

- If the SD collection contains no variable record (from the list `(NC)->vars`) that represents this dimension, promote the dimension to a variable record as described in the case of setting dimension attribute in Section 7.6.4, "Dimension," and illustrated in Figure 7x, "SD collection contents in memory after adding a dimension attribute." At this point, the dimension has a variable record and the scale values are written to the variable record.
- If this dimension already has a variable record, the record is updated with the scale values.

In both cases, the number type of the dimension is set via a call to **SDsetdimscale**.

7.8.8 Setting a dimension string

The routine **SDsetdimstrs** sets values to the pre-defined attributes *label*, *unit*, and *format* for a dimension. The process of setting each of these attributes is similar to that of setting a user-defined attribute described in Section 7.6.4, "Dimension," except that the names of these attributes are pre-defined rather than being set by the user. Before setting values for any of these attributes, a variable record is created for this dimension if the record does not already exist. The creation of the variable record for a dimension is illustrated in Figure 7.6.4, "Dimension."

If **SDsetdimstrs** is called before **SDsetdimscale**, then the number type of this dimension will be set to `DFNT_FLOAT32 (5)`.

7.8.9 Terminating access to the SD collection and file

The routine **SDend** terminates access to the SD collection and the HDF file and, if the contents of the structures have changed, writes all the structures to the file. The following steps will be carried out:

- For each dimension
 - a Vdata is created containing the size of the corresponding dimension.
 - a Vgroup for this dimension is created. Its reference number is stored in `(NC_dim)->vgid`, a Vgroup containing the above Vdata.
- For each SDS
 - the record SD that stores the SDS data is written if data has been written to this SDS.
 - the record NT that stores the number type is written.
 - the record SDD that stores the dimension values is written.
 - the NDG record that is formed by the records SD, NT, and SDD is written.
 - a Vgroup for this variable is created. Its reference number is stored in `(NC_var)->vgid`, a Vgroup containing all of the dimensions' Vgroups, the attributes' Vgroups if there are any, and the SD, NT, SDD and NDG records.
- For the SD collection and the HDF file
 - *global* attributes are written.
 - a Vgroup for the top level is created. Its reference number is stored in `(NC)->vgid`, a Vgroup containing all of the *global* attributes' Vgroups, the dimensions' Vgroups, and the SDS Vgroups.

General Raster Images: The GR Model

8.1 Chapter Overview

This chapter provides functional descriptions of the GR Data Model, the GR implementation in the HDF library, and the HDF file structures employed.

- Section 8.2, "Images in an HDF File," describes the types of images that may be found in an HDF file.
- Section 8.3, "The GR Data Model," and Section 8.4, "Mapping between GR Data Model and HDF File Structures," describe the GR data model, including a rigorous UML representation, and the mapping of the model's elements to HDF data structures.
- Section 8.5, "Modifying an RIG or RI8 Image via the GR Interface," discusses the interaction of the GR interface with older-style RIG and RI8 images.
- Section 8.6, "Backwards Compatibility when Creating New Images via the GR Interface," through Section 8.8, "Relationships among Main Data Structures," describe the GR implementation in the HDF library and the data structures employed.
- Section 8.9, "The Evolution of an HDF File in the GR Interface," then illustrates several steps in the evolution of the contents in an HDF file under the GR interface. At each step, the correspondence between the information as stored in memory and as represented in the file is described.

Many of the figures in this chapter employ UML notation (Unified Modeling Language notation) to show object relationships. See Section 7.2, "UML Notation and Object Symbols in HDF Data Model Descriptions."

8.2 Images in an HDF File

An HDF file may contain many elements, including general raster images (GR data sets, the subject of this chapter) and older-style images, palettes, scientific data sets (SDSs), groups of HDF objects, annotations, etc. Figure 8a provides a high-level illustration of the elements of an HDF file.

FIGURE 8a

An HDF file may contain several objects and object collections

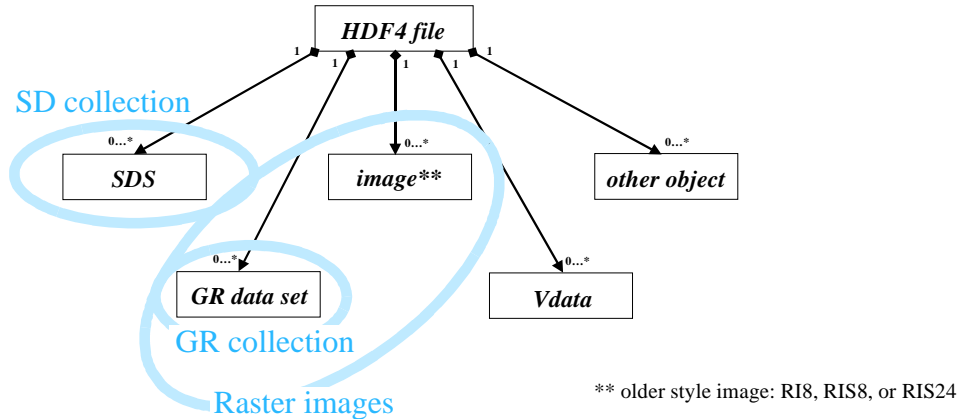

When a file is opened with the GR interface, all of the raster images in the file, including the older RI8, RIS8, and RIS24 images, become visible to the application, as illustrated in Figure 8b below. Other objects in the file are unavailable through the GR interface; they can, however, be accessed through other interfaces, e.g., the H, V, and SD interfaces.

FIGURE 8b

An HDF file opened with the GR interface

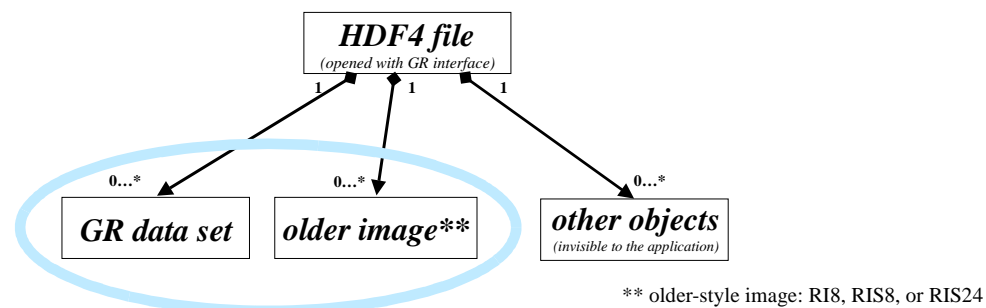

As indicated in these figures, an HDF file may contain any of several styles of raster images; this is due to the history of HDF development and the need to maintain backwards compatibility. The older-style raster images, RIG and RI8, will occur in HDF files created with older versions of the HDF library. (See also Section 8.6, "Backwards Compatibility when Creating New Images via the GR Interface" regarding the current library's ability to create these older-style images.) Figure 8c lists the properties of the three types of images, GR, RIG, and RI8, providing a tabulated comparison. The three following subsections describe these images in more detail.

FIGURE 8c

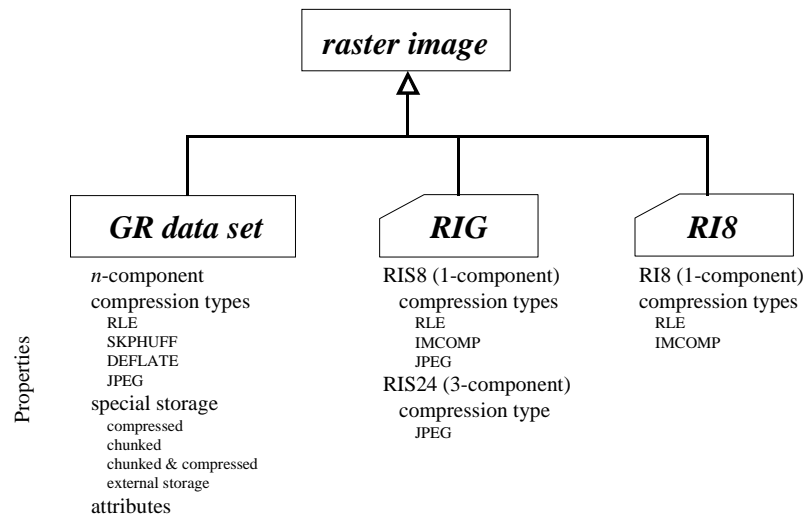
Three types of raster image**8.2.1 GR data sets**

The newest form of raster image in HDF is the general raster image. These images are represented by *GR data sets* and are referred to as such throughout this and other HDF documents. GR data sets were introduced at HDF Release 4.0.

GR data sets provide an extended color capability, global and local attributes, and special storage capabilities. The elements of a GR data set include the following HDF objects:

- Raster image data
 - compressed image data (RLE or run length encoding, SKPHUFF or Skipping-Huffman, DEFLATE, and JPEG)
 - special storage layout (compressed, chunked, compressed and chunked, or external)
- Image dimension
- Image attribute
- Palette
- Palette dimension

In the file, a GR data set consists of a Vgroup and several elements, as discussed in Section 8.4, "Mapping between GR Data Model and HDF File Structures," and illustrated in Figure 8j on page 89.

The GR data sets in a file constitute a GR collection, described in Section 8.3, "The GR Data Model."

GR data sets are created and manipulated via the GR interface (the GR API); see Section 8.9, "The Evolution of an HDF File in the GR Interface." The GR interface also reads, and can manipulate, older-style raster images; see Section 8.5, "Modifying an RIG or RI8 Image via the GR Interface."

8.2.2 RIG images (RIS8 and RIS24)

Raster image groups (RIGs), including RIS8 and RIS24 images, were the first HDF images to employ a grouping structure and provided the first 24-bit color image capability in HDF, while also providing extended compression capabilities. RIGs were the immediate predecessors to the GR approach and were introduced at HDF Release 2.0.

RIG images are represented by a raster image group (RIG) that contains pointers to other HDF objects. This type of raster image does not have attributes but does have all the other elements in the GR list above. Characteristics particular to RIGs are as follows:

- All RIG images are made up of 8-bit components.
- An RIS8 image is a 1-component, or 8-bit, RIG; an RIS24 image is a 3-component, or 24-bit, RIG.
- RIG compression modes are RLE (run-length encoding), IMCOMP, and JPEG.

Figure 8d presents the file elements that make up an RIG image with a palette, which is optional.

FIGURE 8d

RIG with raster image and palette

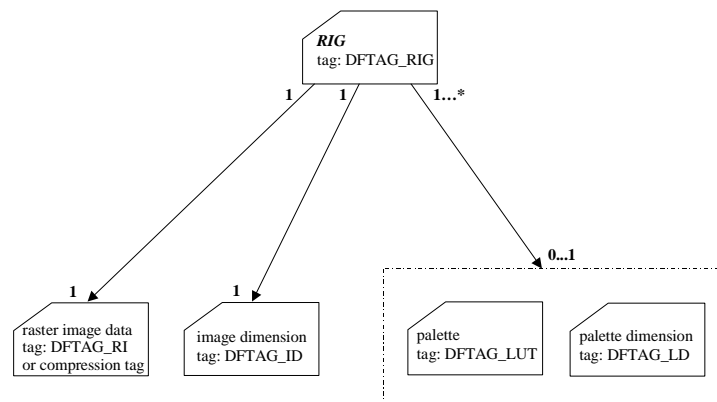

An RIG is a tag/ref object and is fully described in Section 9.3.4, "Raster Image Tags," in Chapter 9, *Tag Specifications*. The DFTAG_RI, DFTAG_ID, DFTAG_LUT, and DFTAG_LD objects are fully described in the same chapter.

8.2.3 RI8 images

The RI8 image is the original HDF 8-bit raster image and provides basic compression capabilities. RI8 images are characterized as follows:

- RI8 images employ no grouping structure.
- There are three compression modes for RI8 images:
 - uncompressed images identified by the tag DFTAG_RI8
 - RLE-compressed images identified by the tag DFTAG_CI8
 - IMCOMP-compressed images identified by the tag DFTAG_II8
- Image dimensions are identified by the tag DFTAG_ID8.
- Palette dimensions are identified by the tag DFTAG_IP8.

An RI8 image is a tag/ref object and is fully described in Section 9.3.9, "Obsolete Tags," in Chapter 9, *Tag Specifications*.

The ability of the current library to process RIG and RI8 images is intended only to support backward compatibility. The RIG and RI8 interfaces are both obsolete APIs and it is highly recommended that only the GR interface be used in new applications.

8.3 The GR Data Model

This section provides a logical description of an HDF file containing GR images. A user's view of the data model is presented in Section 8.3.1, "A Casual View," and Figure 8e, "A sample user's view of the GR model." The formal data model and a graphical representation are presented in Section 8.3.2, "The Formal GR Data Model," and Figure 8f, "GR data model."

8.3.1 A Casual View

From a user's point of view, an HDF file containing GR data sets is structured as follows and as illustrated in Figure 8e on page 86:

- The file contains GR data sets and optional global attributes.
- Every GR data set includes the following information:
 - Name
 - Number of components
 - Dimension sizes (2 dimensions only)
 - Pixel data type
 - Image interlace mode (by pixel, line, or plane)
- Each GR data set may have the following associated elements and properties
 - Attribute(s)
 - Data
 - A palette
 - Storage layout

A palette is described by the following characteristics:

- Data type
- Number of entries
- Number of components
- Interlace mode

Global attributes, when present, are defined by the user, apply to all raster images in the file, and usually describe the intended usage of the GR data sets in the file. GR data set **attributes**, sometimes known as **local attributes**, are also optional, defined by the user, and describe only that data set.

GR data sets can have one of several storage layouts, as listed in Table 8a.

TABLE 8a

GR storage layouts

GR data set				
contiguous	special storage			
	chunked	compressed	chunked and compressed	external

- Contiguous storage is the default layout and requires no special storage tag.

FIGURE 8e

A sample user's view of the GR model

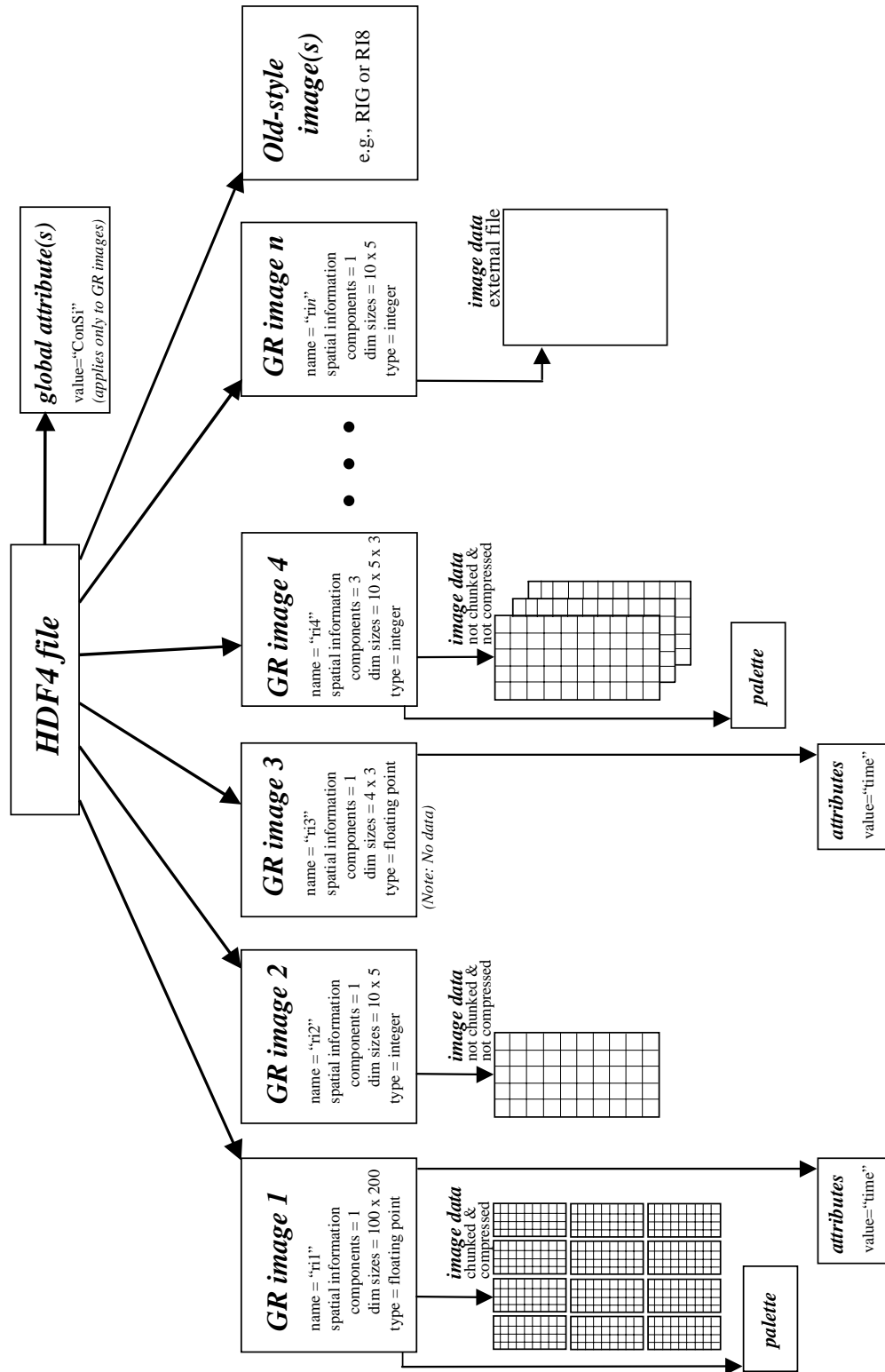

For descriptions and definitions of the required and optional components that make up a general raster image, and of the *GR interface* routines provided by the HDF library to create and access GR data sets in the file, see Chapter 8, "General Raster Images (GR API)," in the *HDF User's Guide*. For a complete description of palettes, see Chapter 9, "Palettes," in the *HDF User's Guide*.

8.3.2 The Formal GR Data Model

The formal GR Data Model includes one type of object the user does not actually see, the *GR collection*. An HDF file may contain zero or one *GR collection* which may, in turn, contain zero or more GR data sets. The optional *global attributes* are actually associated with the GR collection.

A *GR data set* is an HDF data structure used to store a generalized raster image and the supporting metadata. Each GR data set may have zero or more associated *attributes*, sometimes referred to as local attributes.

The GR data sets and the associated objects (see Figure 8f) can be accessed only through the GR interface.

FIGURE 8f

GR data model

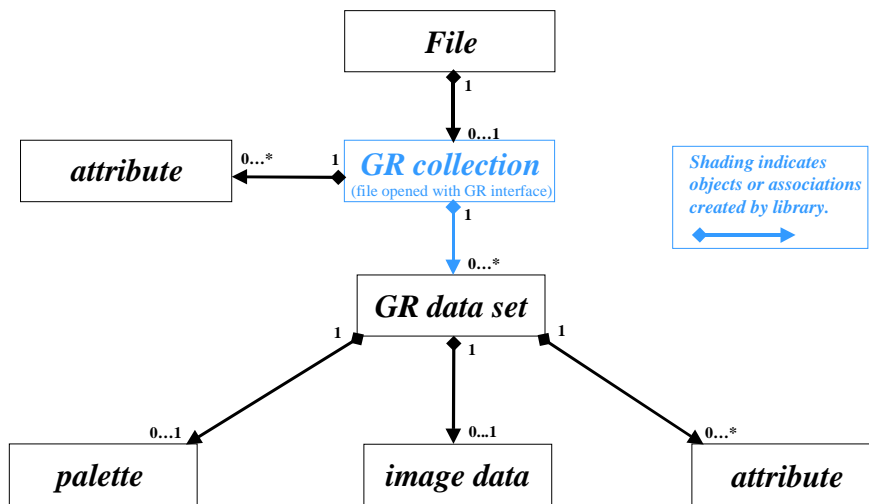

The formal model is based on relationships among user-specified objects of the GR Data Model and the associated object attributes, as described in Figure 8g.

FIGURE 8g

GR Data model objects

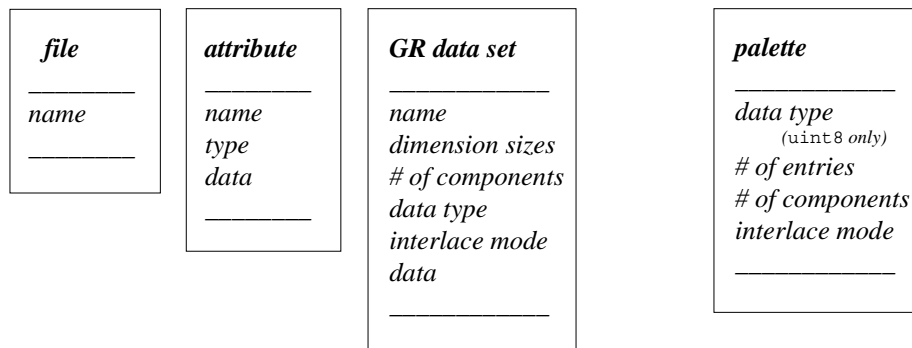

The GR interface provides routines to access the objects depicted in Section FIGURE 8e, "A sample user's view of the GR model," and Section FIGURE 8g, "GR Data model objects." If an object is part of another object, it cannot be accessed by the GR interface without first accessing that other object; e.g., palette or attribute information can be accessed only after accessing the associated raster image.





8.4 Mapping between GR Data Model and HDF File Structures

This section describes the mapping between the objects represented in the UML diagram in Figure 8f, "GR data model," and the HDF objects in the file.

The illustrations in this section employ the symbols in Figure 8h to identify file structures.

FIGURE 8h

File structure symbols

Vgroup		Other low-level HDF objects, usually identified by a tag/ref pair	
Vdata		Abstract GR model object	

Elements of the GR data model map to HDF file objects as illustrated in Figure 8i

FIGURE 8i

Model-to-file mapping -- GR_collection

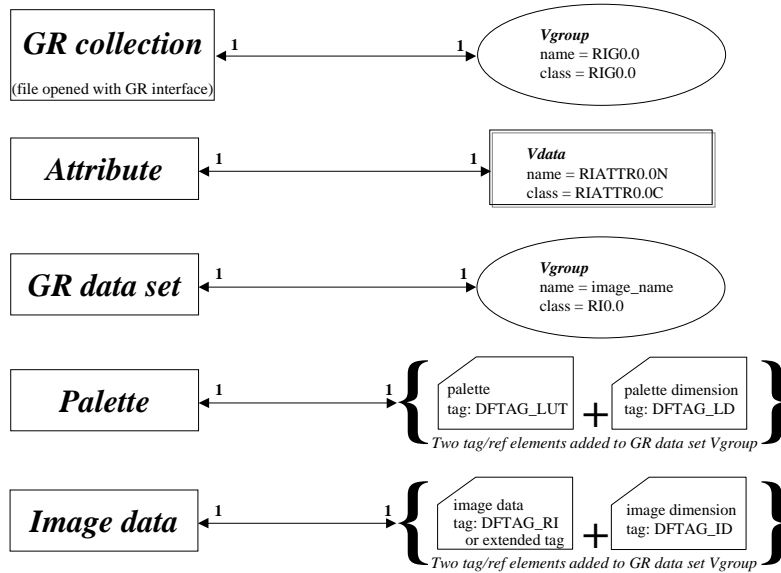

A GR attribute is represented by a Vdata with one field. The field name is the name of the attribute. The field contains the value of the attribute; the number of records in the field corresponds to the number of attribute values. For example, the figure to the right represents an attribute named `attribute_name` with the value `abcd`.

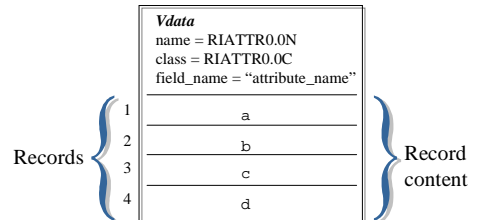
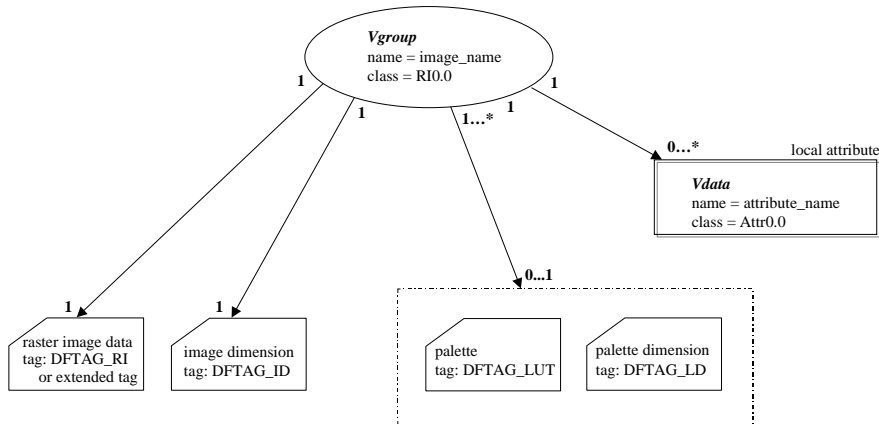

Figure 8j presents the file elements that make up an image, or GR data set, and the relationships among them as created by the GR interface.

FIGURE 8j

File structures representing a GR data set



- For any given image, the Vgroup may contain either
 - raster image data, DFTAG_RI or
 - raster image data in a special storage format, indicated by an extended tag. Extended tags are described in Chapter 10, *Extended Tags and Special Elements*.
- The image dimension object, DFTAG_ID, includes image dimension, interlace mode and compression information. Image compression may be RLE (run length encoding), SKPHUFF (Skipping-Huffman), DEFLATE, or JPEG.
- The GR data set Vgroup must have a class name of RI0.0. Should changes in the GR data structures ever become necessary, the class mechanism will enable the HDF library to manage evolving versions.

Figure 8k graphically presents the relationships among the elements of the formal GR data model. The GR collection is represented by a Vgroup whose members are the global attribute Vdata and the GR data set Vgroups. Each GR data set is represented by a Vgroup whose members are the image data and dimension objects, the palette objects, and the local attribute Vdata.

FIGURE 8k

File structures representing a GR collection

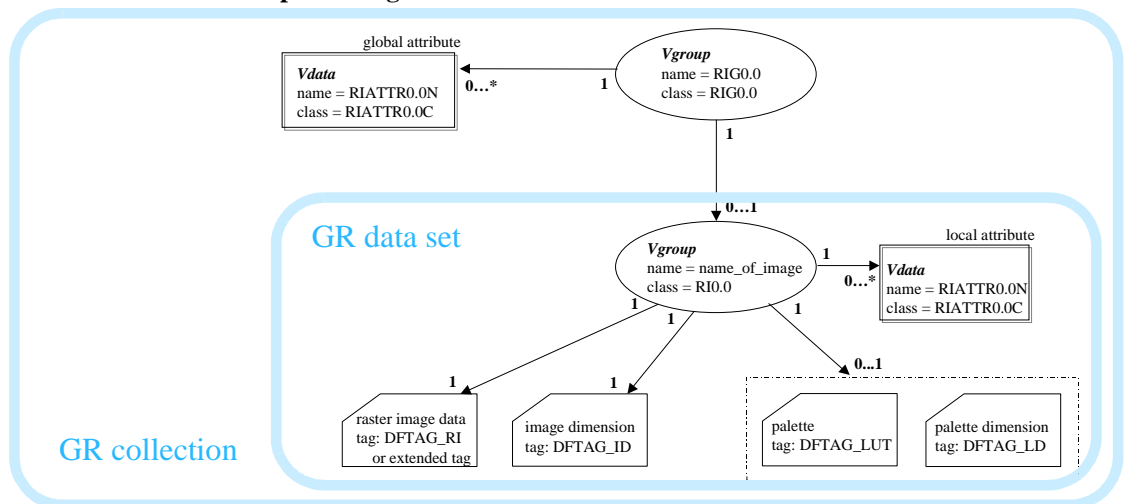

8.5 Modifying an RIG or RI8 Image via the GR Interface

This section discusses the consequences of using the GR API to access and modify older-style RIG and RI8 images. This situation is likely to arise only when using the current version of the HDF library to edit a file that was created with an older version.

Consider the file illustrated in Figure 8l. This file contains one GR data set, one local attribute on that GR data set, one global attribute, one RIG image, and one palette on that RIG image.

FIGURE 8l

File with one GR data set and one RIG image

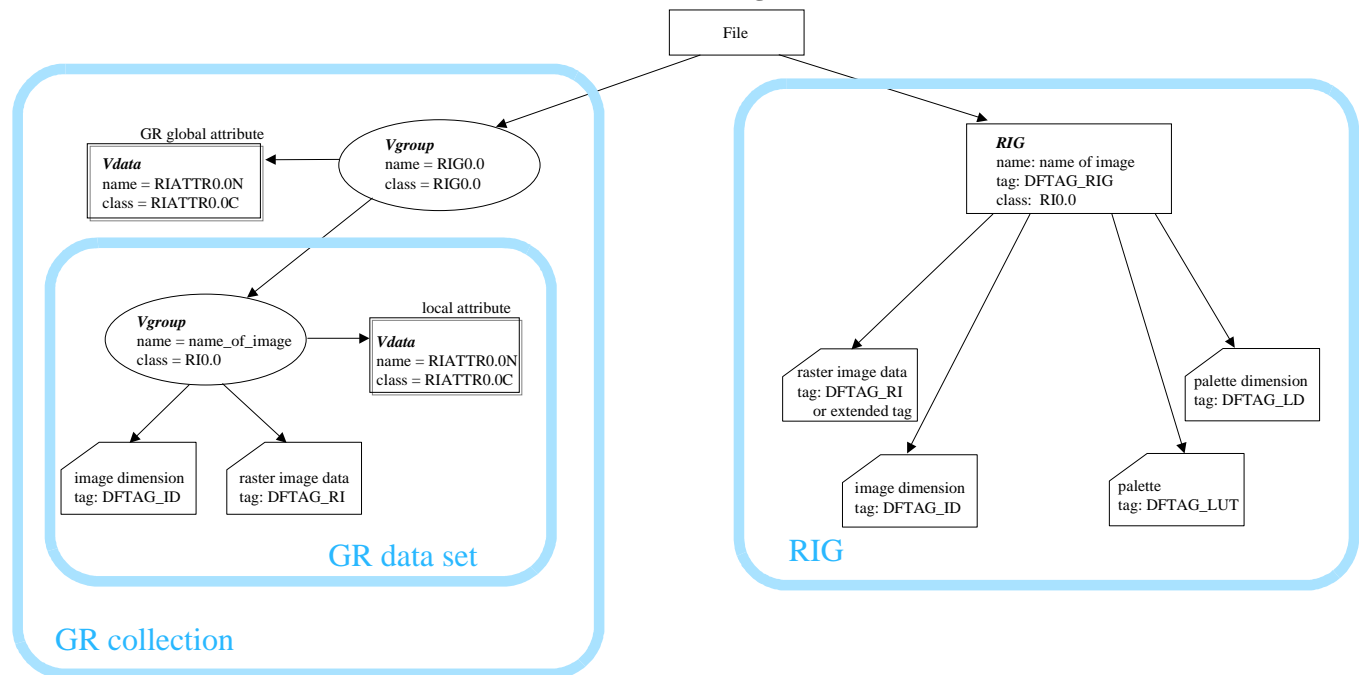

Now consider the use of the GR API to modify the RIG image.

First note that if the GR API modifies just the data of the RIG, e.g., the image or palette values or dimensions, but does *not* add an attribute, GR makes no changes to the file structure.

If an attribute is added, however, GR creates a Vgroup for a new GR data set, links the elements of the image (DFTAG_RI or extended tag in the case of special storage, DFTAG_ID, DFTAG_LUT, and DFTAG_LD) into that Vgroup, and adds the attribute Vdata.

The RIG group element (DFTAG_RIG) is not linked into the GR data set Vgroup. The RIG image remains available via the older interfaces, though those interfaces will not show the attribute. Figure 8m illustrates the structure of the file after an attribute has been added to the RIG image by means of the GR interface.

An RI8 image is incorporated into the GR collection under the same circumstances and in the same manner as the elements of an RIG image. The only difference is that there is not RIG object (DFTAG_RIG) to consider.

When the GR interface is initiated, the information about the HDF file and its contents are mapped into memory and stored in the GR interface's main data structures, as discussed in Section 8.7, "Main Data Structures and their Relationships." These structures then maintain and update the information during processing of the application, and they are described in more details

in the next section. When all processing is done, if the file contents have changed, the physical file will be updated with the information stored in the data structures.

FIGURE 8m

File of Figure 8l after GR API has been used to add an attribute to the RIG image

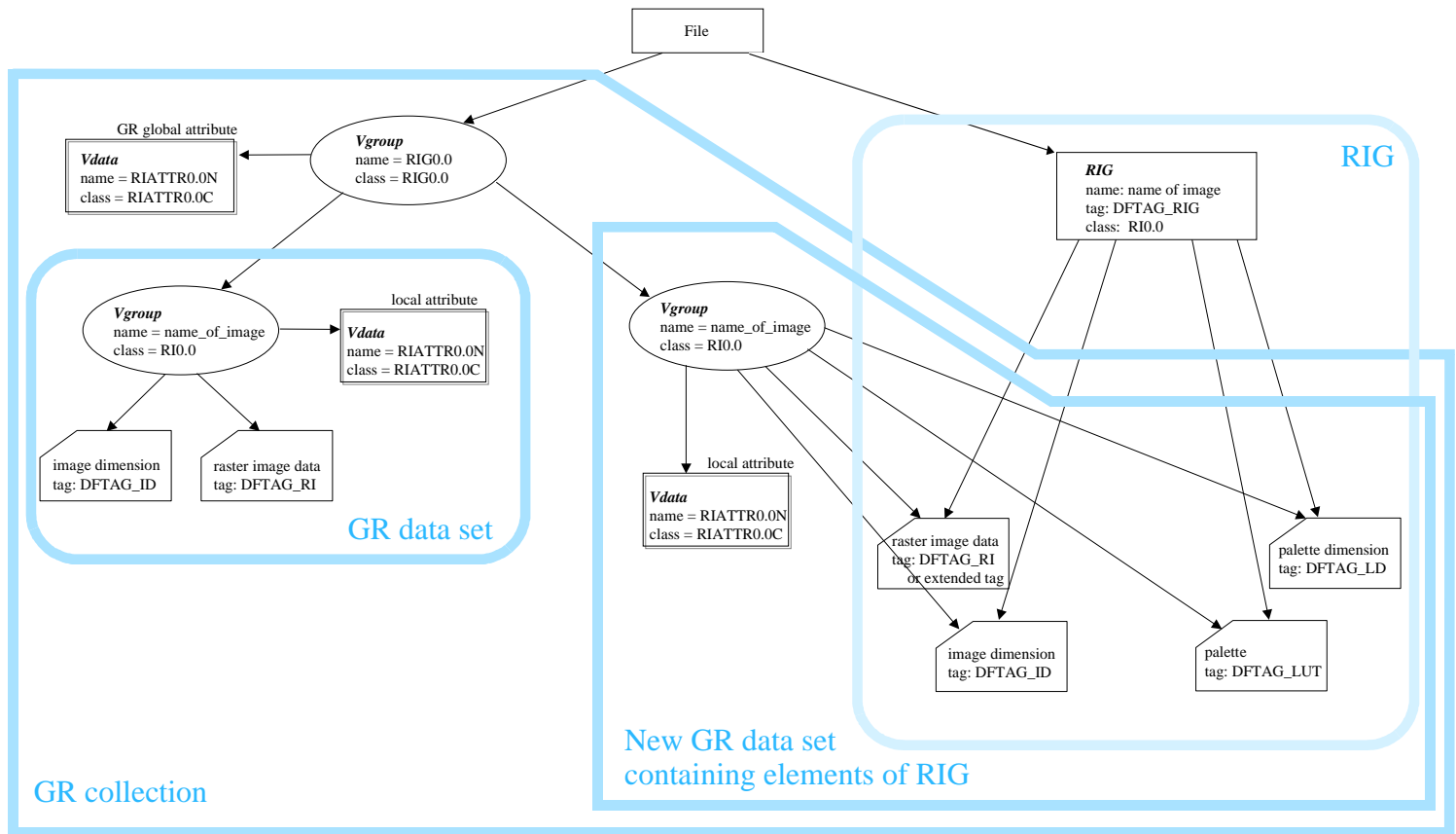

8.6 Backwards Compatibility when Creating New Images via the GR Interface

The HDF library makes extensive efforts to maintain backwards compatibility. When a new image is created via the GR interface, the library creates as many as possible of the following versions of the image:

- A GR data set is always created.
- An RIG is created for every image that meets the RIG criteria. For example, an RIG can be created for 1-component or 3-component images if the components are 8-bit integers and the compression mode is available for an RIG image. The images would be RIS8 or RIS24, respectively. If the image includes an attribute, that attribute will appear in the GR version of the image but will not be accessible in the RIG version.
- An RI8 image is created if the image meets the RI8 criteria. For example, an RI8 can be created for a 1-component, 8-bit image that uses a compression mode available for an RI8 image.

8.7 Main Data Structures and their Relationships

This section provides the description of the main data structures used in the GR interface to store a GR data set's contents in memory. Figure 8n lists these data structures and all their elements.

<code>gr_info_t</code>	File information structure storing information about the HDF file.
<code>ri_info_t</code>	Raster image information structure storing information about a raster image.
<code>at_info_t</code>	Attribute information structure storing local and global attribute information.
<code>dim_info_t</code>	Dimension information structure storing both image and palette dimension information.

These structures are somewhat self-described in Figure 8n, except for some details too complex to present in the figure. The following subsections provide additional details about these structures. The last subsection in this section describes the relationships among the data structures.

FIGURE 8n

Main data structures in GR interface

`gr_info_t`: this structure holds the file information

```
int32 hdf_file_id - the corresponding HDF file ID
uint16 gr_ref - ref # of the Vgroup of the GR in the file
int32 gr_count - # of image entries in grtree so far
TBBT_TREE *grtree - root of image B-Tree
uintn gr_modified - whether any images have been modified
int32 gattr_count - # of global attr entries in gattree so far
TBBT_TREE *gattree - root of global attribute B-Tree
uintn gattr_modified - whether any global attributes have been modified
intn access - the number of active pointers to this file
uint32 attr_cache - the threshold for the attribute sizes to cache
```

`ri_info_t`: this structure holds the raster image information

```
int32 index - index of this image
uint16 ri_ref - ref # of the RI Vgroup
uint16 rig_ref - ref # of the RIG group
gr_info_t *gr_ptr - ptr to the GR info that this ri_info applies to
dim_info_t img_dim - image dimension information
dim_info_t lut_dim - palette dimension information
uint16 img_tag, img_ref - tag & ref of the image data
int32 img_aid - AID for the image data
intn acc_perm - Access permission (read/write) for image AID
uint16 lut_tag, lut_ref - tag & ref of the palette data
gr_interlace_t im_il - interlace of image when next read (default PIXEL)
gr_interlace_t lut_il - interlace of LUT when next read
uintn data_modified - whether the image or palette data has been modified
uintn meta_modified - whether the image or palette meta-info has been modified
uintn attr_modified - whether the attributes have been modified
char *name - name of the image
int32 latr_count - # of local attr entries in ri_info so far
TBBT_TREE *lattree - Root of the local attribute B-Tree
intn access - the number of times this image has been selected
uintn use_buf_drvr - access to image needs to be through the buffered special element driver
uintn use_cr_drvr - access to image needs to be through the compressed raster special element driver
uintn comp_img - whether to compress image data
int32 comp_type - compression type
comp_info cinfo - compression information
uintn ext_img - whether to make image data external
char *ext_name - name of the external file
int32 ext_offset - offset in the external file
uintn acc_img - whether to make image data a different access type
uintn acc_type - type of access-mode to get image data with
uintn fill_img - whether to fill image, or just store fill value
void * fill_value - pointer to the fill value (NULL means use default fill value of 0)
uintn store_fill - whether to add fill value attribute or not
```

`at_info_t`: this structure holds the attribute information

```
int32 index - index of the attribute
int32 nt - number type of the attribute
int32 len - length/order of the attribute
uint16 ref - ref of the attribute (stored in VData)
uintn data_modified - whether the attribute data has been modified
uintn new_at - whether the attribute was added to the Vgroup
char *name - name of the attribute
void * data - data for the attribute
```

`dim_info_t`: this structure holds the image and palette dimension information

```
uint16 dim_ref - reference # of the Dim record
int32 xdim, ydim - dimensions of the image or palette
int32 ncomps - number of comps of each pixel in image
int32 nt - number type of the components
int32 file_nt_subclass - number type subclass of data on disk
gr_interlace_t il - interlace of the comps (stored on disk)
uint16 nt_tag, nt_ref - tag & ref of the number-type info
uint16 comp_tag, comp_ref - tag & ref of the compression info
```

8.7.1 File Information Structure (`gr_info_t`)

The `gr_info_t` structure contains the information describing the HDF file whose identifier is stored in `hdf_file_id` (refer to Figure 8n).

Additional details are as follows:

- `gr_ref` is the reference number of the top level Vgroup in Figure 8k.
- `grtree` points to the tree whose nodes link to the raster image information structure describing an image in the file (see Figure 8q). Note that the images stored in this tree may include images read in from an existing file and images created in the application.
- `gr_count` indicates the number of nodes in the tree `grtree`, i.e., the number of images currently stored in the file information structure.
- `gr_modified` and `gattr_modified` ensure that the file will be updated during **GRend** processing.
- `gattree` points to the tree whose nodes link to the attribute information structure which describes a global attribute in the file (see Figure 8q). Note that the attributes stored in this tree may include attributes read in from an existing file and attributes created in the application.
- `gattr_count` indicates the number of nodes in the global attribute tree `gattree`, i.e., the number of global attributes currently stored in the file information structure.

8.7.2 Raster Image Information Structure (`ri_info_t`)

The `ri_info_t` structure contains information describing a raster image.

When an existing file is opened, its contents are retrieved and stored in the data structures. The contents may include raster images, which may be of any type described in Section 8.2, "Images in an HDF File." The following table illustrates how different reference numbers in this structure are used to store the in-file representation of the three types of raster images. Notice that `dim_ref` in the table belongs to the dimension information structure; however, because the dimension information structure is used by this image for both the image dimension and the image's palette dimension, it makes more sense to describe the dimensions' reference number here.

TABLE 8b

Reference numbers and the in-file representation of raster images

	GR data set	RIG raster image	Non-group raster image
<code>ri_ref</code>	Ref# of GR data set Vgroup	DFREF_WILDCARD	DFREF_WILDCARD
<code>rig_ref</code>	<code>aux_ref?</code> or DFREF_WILDCARD	Ref# of RIG group	DFREF_WILDCARD
<code>img_ref</code>	Ref# of either the raster image data or the compressed image data	Ref# of either the raster image data or the compressed image data	Ref# of one of the following: <ul style="list-style-type: none"> • 8-bit raster image • RLE compressed 8-bit raster image • IMCOMP compressed 8-bit raster image
<code>lut_ref</code>	Ref# of the palette	Ref# of the palette	Ref# of one of the following: <ul style="list-style-type: none"> • 8-bit palette • RLE compressed 8-bit palette • IMCOMP compressed 8-bit palette
<code>img_dim.dim_ref</code>	Ref# of the image dimension	Ref# of the image dimension	DFREF_WILDCARD
<code>lut_dim.dim_ref</code>	Ref# of the palette dimension	Ref# of the palette dimension	DFREF_WILDCARD

Additional details are as follows:

- `img_dim` is a structure describing the image dimension, as in Figure 8j and Figure 8k.
- `lut_dim` is a structure describing the palette dimension in Figure 8j and Figure 8k.
- `data_modified`, `meta_modified`, and `attr_modified` ensure that the file will be updated as necessary during the **GRend** processing.
- `lattree` points to the tree whose nodes link to the attribute information structure which describes an attribute of the image (see Figure 8r). Note that the attributes stored in this tree may include attributes read in from an existing file and attributes created in the application.
- `lattr_count` indicates the number of nodes in the local attribute tree `lattree`, i.e., the number of image attributes currently stored in the file information structure.

8.7.3 Attribute Information Structure (`at_info_t`)

The `at_info_t` structure is used to store the information describing a local or global attribute.

Additional details are as follows:

- `ref` is the reference number of the Vdata representing a global or local attribute in Figure 8k.
- `new_at` ensures that an attribute that is newly created in an application is permanently recorded in the file before the file is closed. If this flag is set, **GRend** will add the tag/reference number pair of the Vdata that represents a local or global attribute to its RI Vgroup or the GR Vgroup, accordingly.

8.7.4 Dimension Information Structure (`dim_info_t`)

The `dim_info_t` structure is used to store the information describing an image or palette dimension.

8.8 Relationships among Main Data Structures

Figure 8o provides a high-level illustration of the relationships among these data structures while Figure 8p, Figure 8q, and Figure 8r depict the relationships in more detail. As illustrated, the data structures `TBBT_TREE` and `TBBT_NODE` are widely used in the GR interface. `TBBT_TREE` is a threaded, balanced, binary tree that is used to store different lists of objects and their information. Part of the definition of the tree can be found in Figure 8p. Basically, the tree is a structure that has a pointer, called `root`, pointing to another structure, `TBBT_NODE`, which is a node of the tree. The main elements of `TBBT_NODE` include two `void` pointers, `data` and `key`, and an array of three pointers that point to the parent, the left child, and the right child of the current node. The pointer `data` points to the data structure that is stored in this tree. The pointer `key` points to the value that is used to search for the data in the tree.

FIGURE 80

High-level description of the relationships among the main data structures

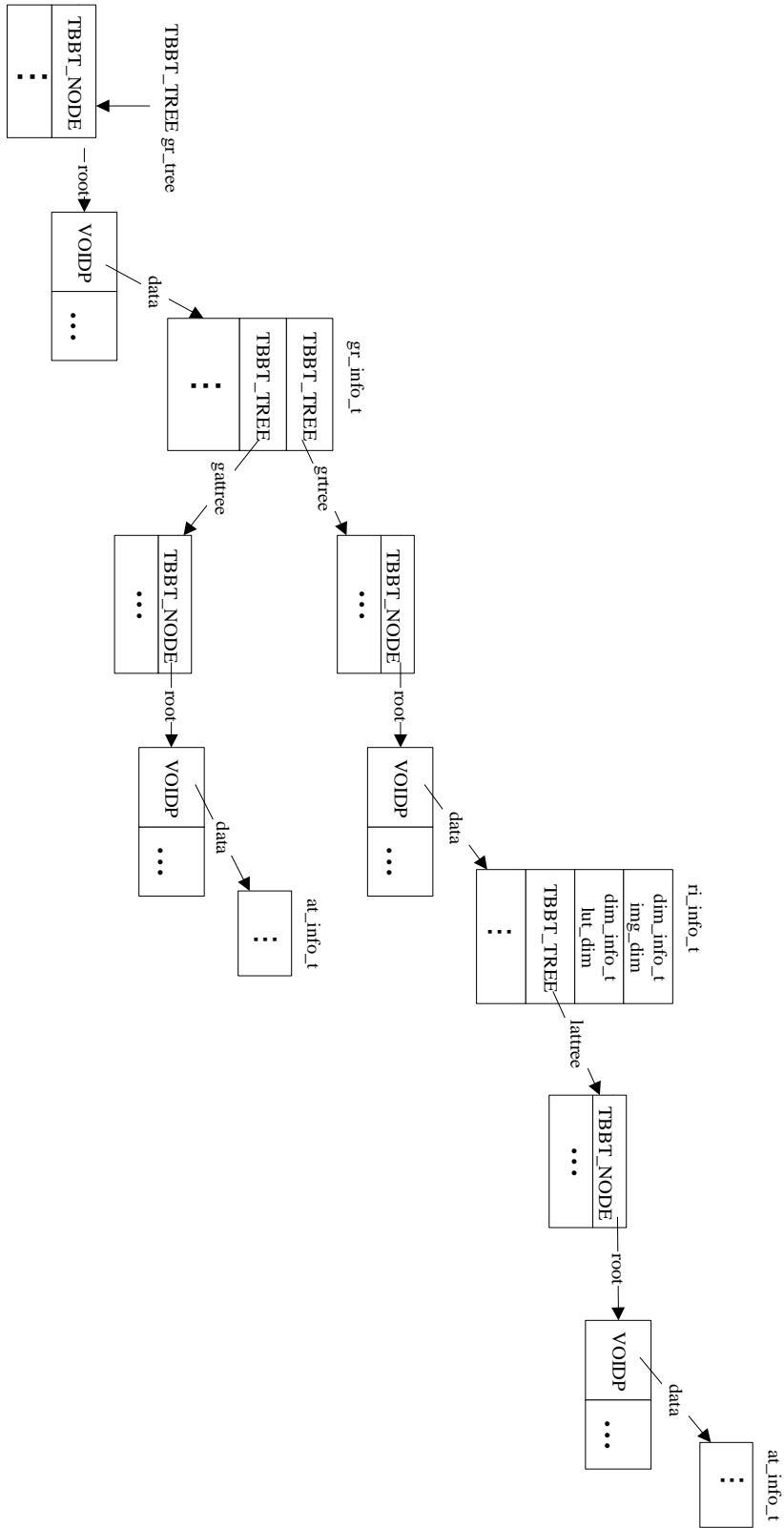

Figure 8p shows a global tree `gr_tree` that holds the GR file structure `gr_info_t`, which is used to store the file contents that are read into memory for processing or that are newly created and will be written to the file. The global tree `gr_tree` is allocated when **GRstart** is first invoked in an application. A new structure of `gr_info_t` is also created and inserted into the tree at this time (routine **New_grfile**). If **GRstart** is invoked more than once for a file in an application, then the global tree `gr_tree` already exists and the current structure `gr_info_t` will be used (routine **Get_grfile**). The key value used for searching in this tree is the HDF file identifier.

FIGURE 8p

The global GR tree

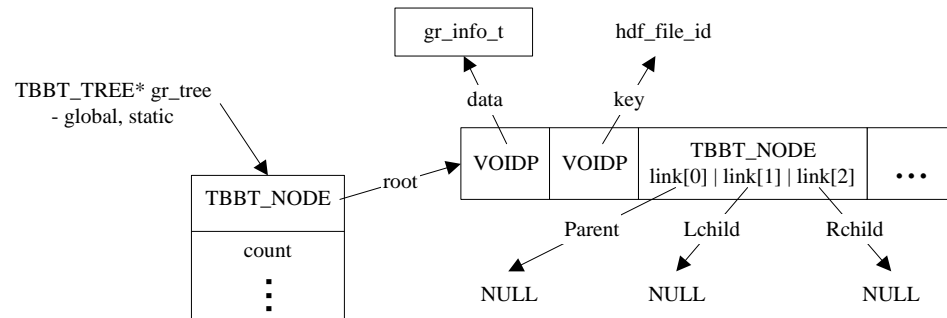

Figure 8q describes the elements of the GR file structure `gr_info_t`. This structure contains two `TBBT_TREE` trees, `grtree` and `gattree`. The tree `grtree` contains the information for all the images in the file; thus, the pointer `data` in its nodes points to a raster image information structure, `ri_info_t`. Similarly, the tree `gattree` contains the information for all the global attributes in the file and its nodes point to the attribute information structure, `at_info_t`. If the file, which `gr_info_t` represents, has not been accessed in the current application, **GRstart** fills in the initial information of the GR file structure, which includes the creation of the two trees, `grtree` and `gattree`. **GRstart** then invokes **GRiget_image_list** to read in the file contents and store in the global tree `gr_tree` as follows:

- For each of the global attributes, an attribute structure, `at_info_t`, is created and inserted into the attribute tree `gattree`, branching out from `gr_tree`.
- For each of the raster images, a raster image structure, `ri_info_t`, is created and inserted into the `grtree`. Figure 8r illustrates the raster image structure and its main elements. These elements include two dimension information structures, `dim_info_t`, describing the image dimension and the image's palette dimension; a compression information structure, `comp_info`, describing the image's compression; and a tree, `TBBT_TREE`, holding all the attributes of the image.
- For each attribute of a raster image, an attribute structure, `at_info_t`, is created and inserted into the attribute tree `lattree` branching out from the raster image's structure.

FIGURE 8q

Illustration of data structure gr_info_t

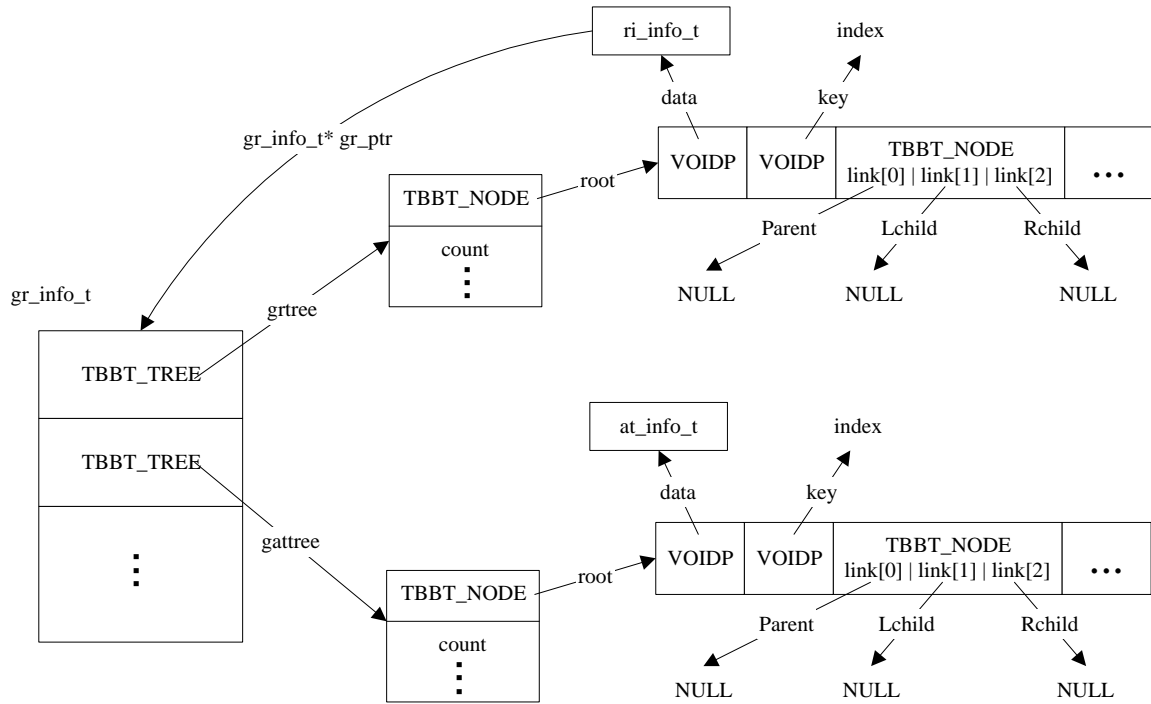
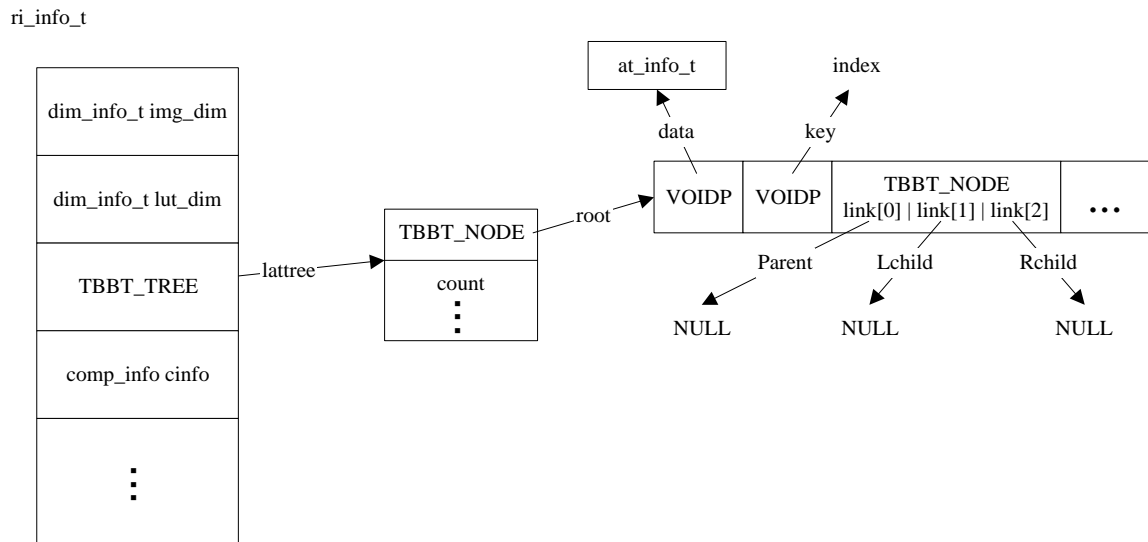

FIGURE 8r

Illustration of data structure ri_info_t



8.9 The Evolution of an HDF File in the GR Interface

This section illustrates several steps in the evolution of the contents in an HDF file under the GR interface. At each step, the correspondence between the information as stored in memory and as represented in the file is described.

- The file is created for access from the GR interface.
- Two raster images are created and written with data.
- Attributes are added to the file and to one of the raster images.
- A palette is added for one of the raster images.

The section also illustrates how the main GR structures represent the file elements in memory. The routines involved in constructing the file are described as necessary.

8.9.1 Creating or Opening an HDF File

A typical HDF5 application calls the routine **Hopen** to create a new HDF file or to open an existing file.

Next, the routine **GRstart** is called to initiate the GR interface. **GRstart** does the following:

- Allocates the file information tree, `gr_tree`. (Note that if **GRstart** is called more than once for the same HDF file, this tree will not be allocated again.)
- Initializes the atom groups for GR data sets (and older-style raster images).
- Retrieves the information of all contents in the file into the tree by invoking **GRiget_image_list**, which fills in `gr_tree` with structures such as `gr_info_t`, `ri_info_t`, `at_info_t`, and `dim_info_t`.

At the end of **GRstart**, a newly created HDF file is represented in memory as shown in Figure 8s. Since there are neither images nor global attributes in the file, the roots of the image tree `grtree` and global attribute tree `gattree` point to `NULL`.

FIGURE 8s

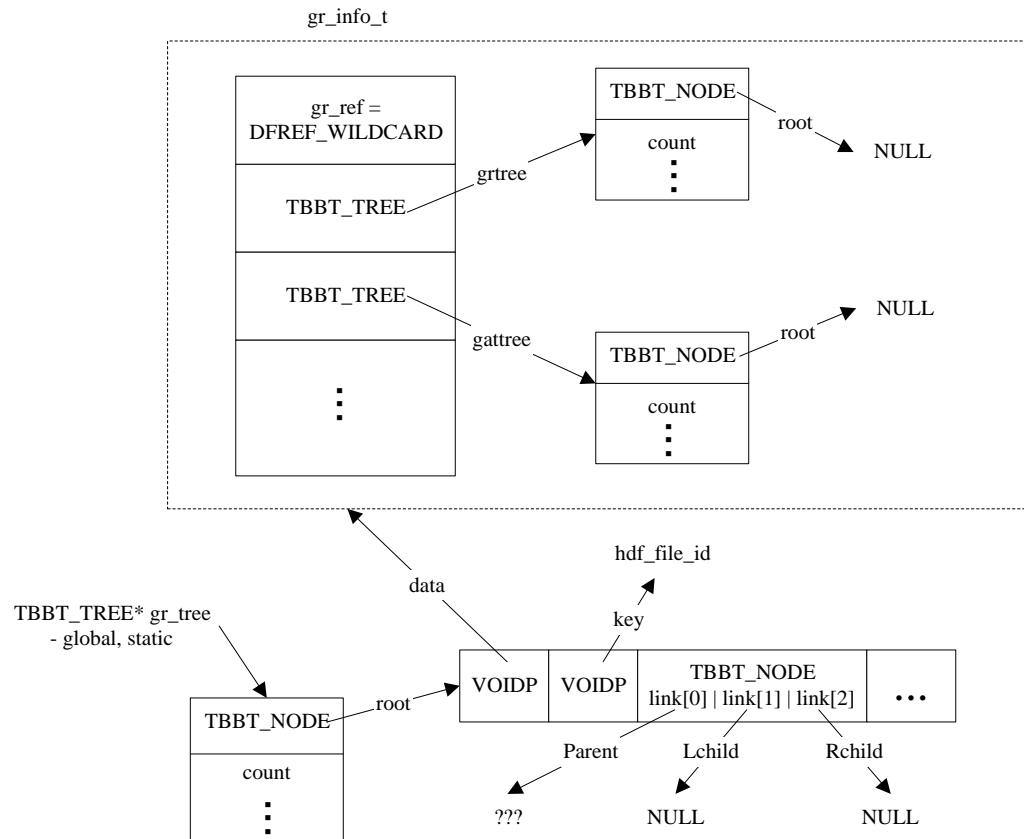
Data structures of a newly created HDF file in memory

Note that the reference number `gr_ref` in `gr_info_t` is `DFREF_WILDCARD` at this time. That indicates that there is not yet a corresponding GR Vgroup in the file. This Vgroup is created during the **GRend** processing and `gr_ref` will then have a valid reference number, which is that of the GR Vgroup and which will then be written into the file.

8.9.2 Creating and Writing to a Raster Image

The routine **GRcreate** creates a raster image in the following steps:

- Creates an `ri_info_t` structure and fills it with initial information.
- Creates a Vgroup for this raster image, i.e., for this GR data set.
- Inserts the structure into the image tree (`gr_info_t`) `grtree`.

Figure 8t illustrates the data structures after two raster images are created. The dashed boxes indicate the new data structures for the two new GR data sets. Notice that the local attribute trees `lattree` point to `NULL` indicating that the raster images have no attributes at this time. For the similar reason, the global tree `gattree` points to `NULL`. When **GRend** is invoked, the contents of the file are updated, causing these new images to be written to the file.

The file being assembled in these sections is illustrated in Figure 8v, "File with two GR data sets, global attribute, local attribute, and image palette."

FIGURE 8t

Data structures storing two raster images

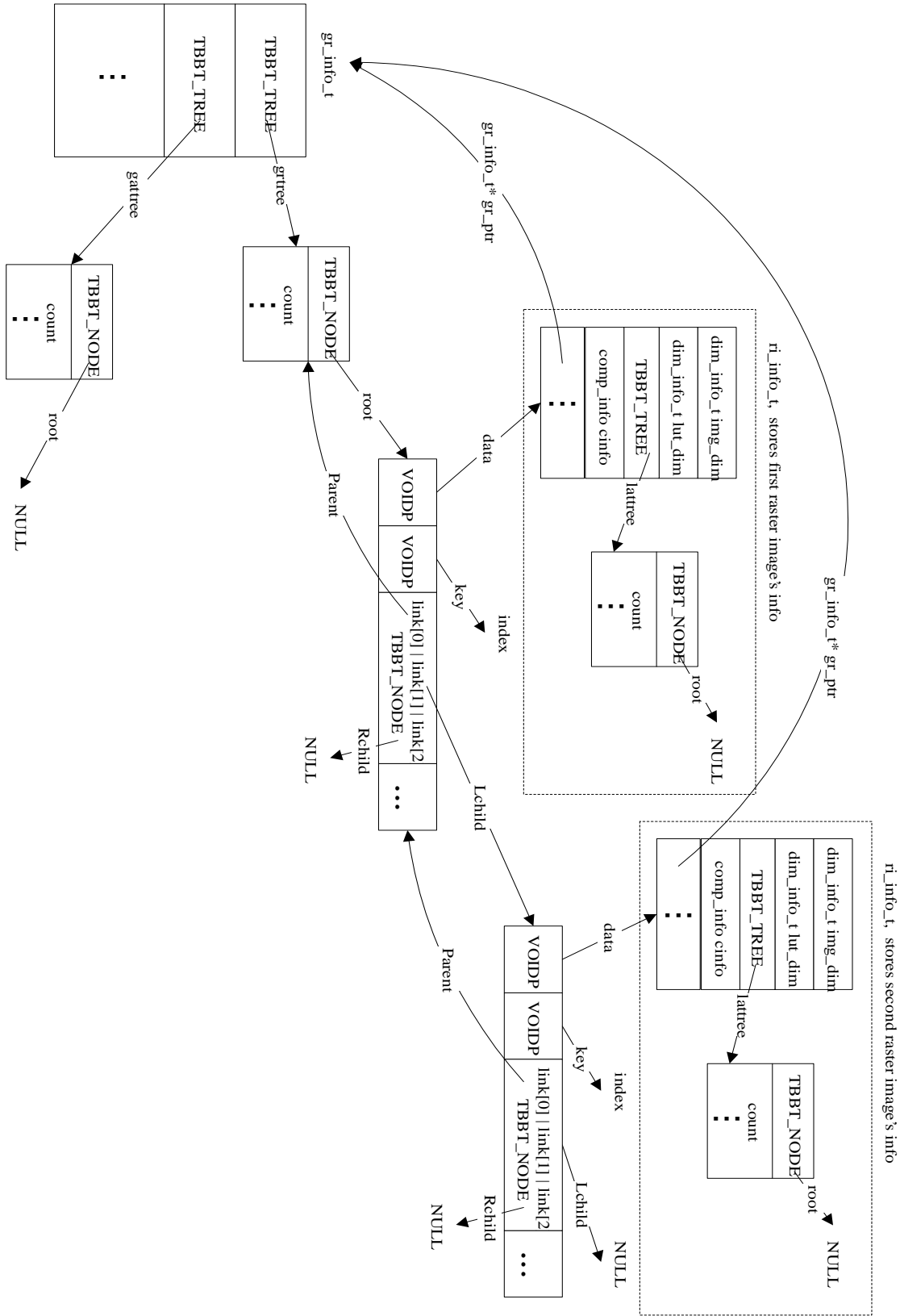

8.9.3 Adding Attributes

The routine **GRsetattr** creates an attribute for a file or for a raster image in the following steps:

- If the attribute already exists in the file, then simply updates it, although, the number type cannot be changed
 - If the attribute's data is small enough to be cached, keeps the data in memory where specified by `(at_info_t)data`.
 - Otherwise, writes the data to the attribute Vdata on disk.
- If the attribute is new, the following actions are performed:
 - Creates the attribute structure `at_info_t` and stores the attribute information.
 - If the attribute's data is small enough to be cached, keeps the data in memory where specified by `(at_info_t)data`.
 - Otherwise, writes the data to the attribute Vdata on disk.
 - Adds the attribute structure to the attribute tree, which can be either the global attribute tree `(gr_info_t)gattree` or the local attribute tree `(ri_info_t)lattree`.

Figure 8u shows the memory data structures with two raster images, one file attribute, and one local attribute. An `at_info_t` structure is also added to the global attribute tree for the new file attribute. When **GRend** is invoked, the contents of the file are updated, causing these attributes be written to the file.

FIGURE 8u

Data structures after adding two attributes

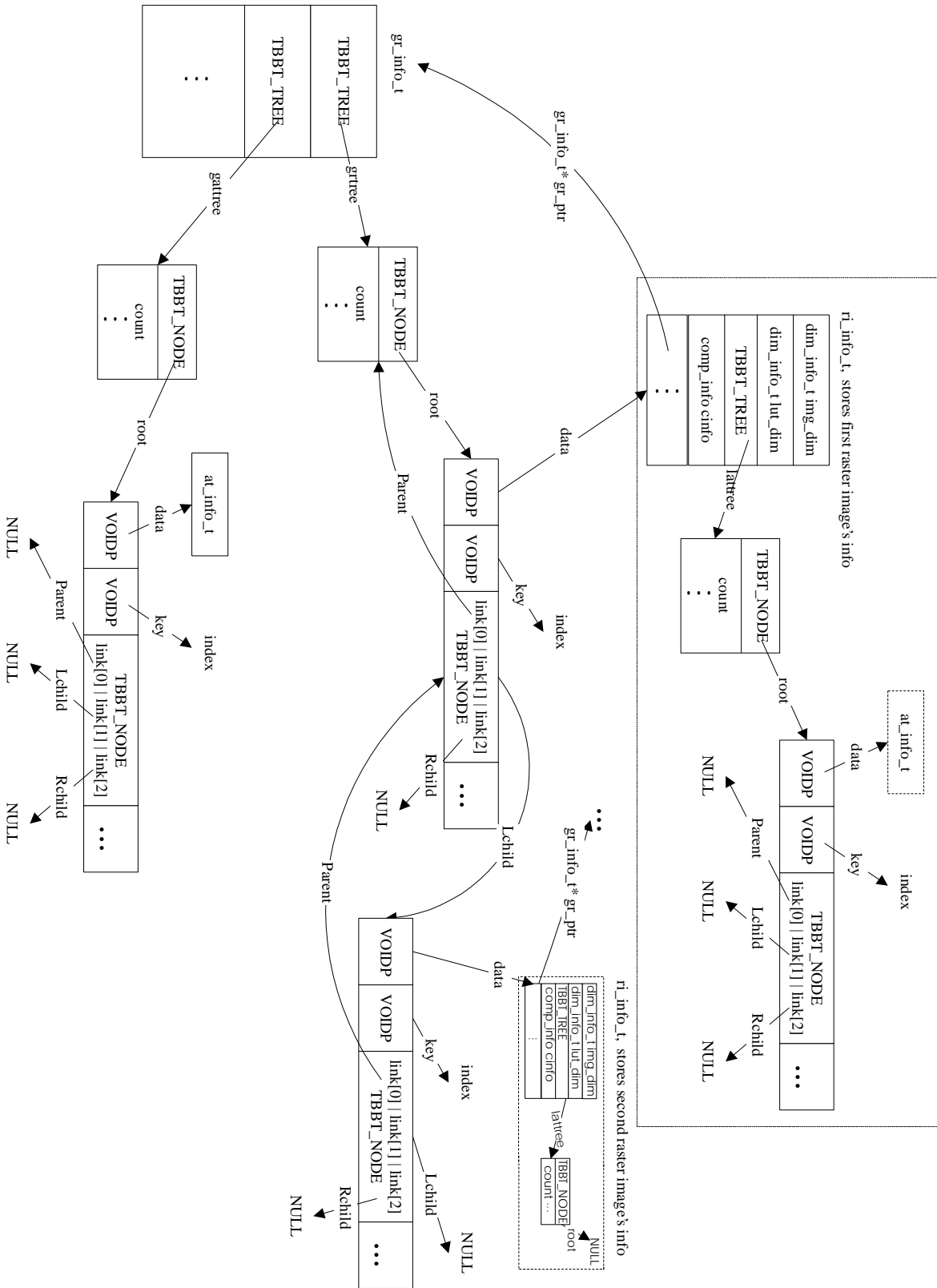

8.9.4 Adding Palettes

The routine **GRwritelut** writes the palette of a raster image in the following steps:

- Makes certain that only standard palettes are written.
- If the palette object already exists for the image, simply writes the palette data to the file.
- Otherwise, creates the palette dimension, initializes it, then creates the palette object and writes the palette data to the file.

There are no structural changes in the data structures. The palette dimension is filled with initial information and the palette object's tag and reference number are stored in the raster image information structure. Figure 8v shows the representation of the file with the new palette object.

FIGURE 8v

File with two GR data sets, global attribute, local attribute, and image palette

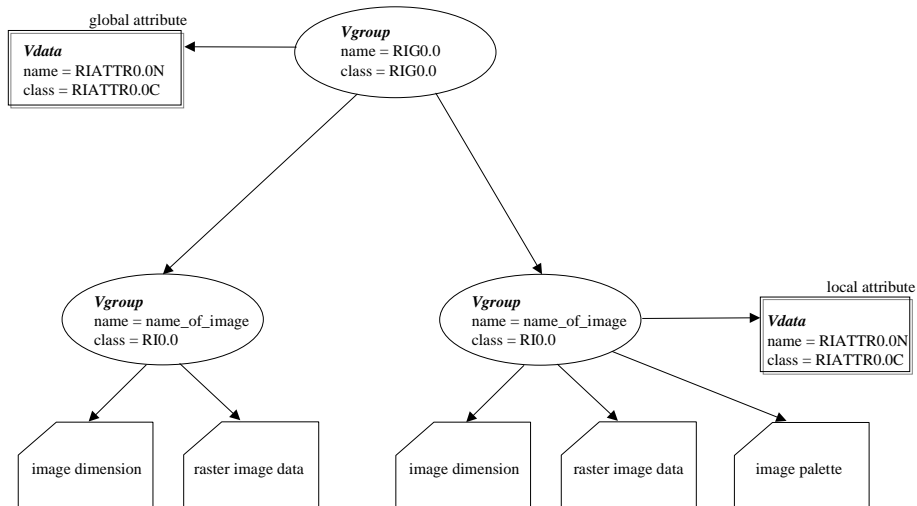

8.9.5 Opening an Existing File

When the HDF file already exists and is opened for processing, the data structure `gr_info_t`, which includes the part enclosed in the dotted box in Figure 8s, is filled with the file contents. For example, Figure 8t shows the in-memory storage of the file that is represented in Figure 8v. The routine **GRiget_image_list** is responsible for retrieving the file contents and storing them in memory. The retrieval process is carried out as follows:

- Collect all the raster images in the file, including all three types.
- Collect all the global attributes and, for each attribute, create an `at_info_t` structure and store it on the global attribute tree `gattree`, branched out from the `gr_info_t` structure.
- Eliminate any duplications among the raster images found.
- For each raster image, the following actions are performed:
 - Create an `ri_info_t` structure and fill it with information about the raster image.
 - If any raster image has attributes, for each attribute, create an `at_info_t` structure and store it on the local attribute tree `lattree`, branched out from the `ri_info_t` structure.
 - Store image dimension information in the structure `img_dim` of the `ri_info_t` structure.

- Store palette dimension information in the structure `lut_dim` of the `ri_info_t` structure.
- Finally, store the `ri_info_t` structure for this raster image on the image tree `grtree`, branched out from the `gr_info_t` structure.

Tag Specifications

9.1 Chapter Overview

This chapter and the next address issues related to HDF tags and the data they represent. The first section of this chapter provides general information about tags and their interpretation. The remainder of the chapter contains a complete list of the HDF basic tags supported by NCSA HDF Version 4.1r3 and detailed tag specifications. The next chapter, *Extended Tags and Special Elements*, provides detailed information regarding NCSA-supported HDF extended tags and the special elements they define.

9.2 The HDF Tag Space

As discussed in Chapter 2, "Basic Structure of HDF Files," 16 bits are allotted for an HDF tag number. This provides for 65535 possible tags, ranging from 1 to 65535; zero (0) is not used. This tag space is divided into three ranges:

- 1 – 32767 Reserved for NCSA-supported tags
- 32768 – 64999 Set aside as user-definable tags
- 65000 – 65535 Reserved for expansion of the format

No restrictions are placed on the user-definable tags. Note that tags from this range are not expected to be unique across user-developed HDF applications.

The rest of this chapter is devoted to the NCSA-supported basic tags in the range 1 (0x0001) to 16383 (0x3FFF). The next chapter, *Extended Tags and Special Elements*, is devoted to NCSA-supported extended tags in the range 16384 (0x4000) to 32767 (0x7FFF).

9.3 Tag Specifications

The following pages contain the specifications of the NCSA-supported basic tags in HDF Version 4.1r3. Each entry contains the following information:

- The tag (in capital letters in the left margin)
- The full name of the tag (on the first line to the right)
- The type and, where possible, the amount of data in the corresponding data element (on the second line to the right)

When the data element is a variable-sized data structure—such as text, a string, or a variable-sized array—the amount of data cannot be specified exactly. Where possible, a formula is provided to estimate the amount of data. The string `? bytes` appears when neither the size nor the structure of the data element can be specified.

- The tag number in decimal/(hexadecimal) (on the third line to the right)
- A diagram illustrating the structure of the tag and its associated data

Since all DDs that point to a data element contain data length and data offset fields, these fields are not included in the illustrations.

- A full specification of the tag, including a description of the data element and a discussion of its intended use.

Tags are roughly grouped according to the roles they play:

- Utility tags
- Annotation tags
- Compression tags
- Raster Image tags
- Composite image tags
- Vector image tags
- Scientific data set tags
- Vset tags
- Obsolete tags
- Extended tags (see Chapter 10, "*Extended Tags and Special Elements*")

These groupings imply a general context for the use of each tag; they are not meant to restrict their use.

Please note Section 9.3.9, "Obsolete Tags." These tags have fallen out of use with the continuing development of HDF. They are still recognized by the HDF library, but users should not write new objects using them; they may eventually be dropped from the HDF specification.

In the following discussion, the ground symbol indicates that the DD for this tag includes no pointer to a data element. I.e., there is never a data element associated with the tag.

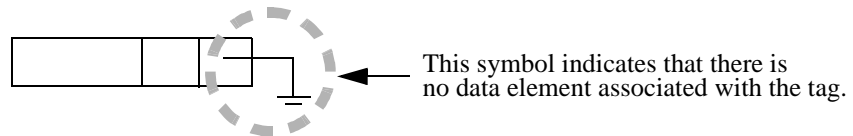

This symbol indicates that there is no data element associated with the tag.

9.3.1 Utility Tags

DFTAG_NULL No data
 0 bytes
 1 (0x0001)

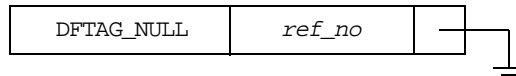

ref_no Reference number (16-bit integer; always 0)

This tag is used for place holding and to fill empty portions of the data description block. The length and offset fields (not shown) of a DFTAG_NULL DD must be zero (0).

DFTAG_VERSION Library version number
 12 bytes plus the length of a string
 30 (0x001E)

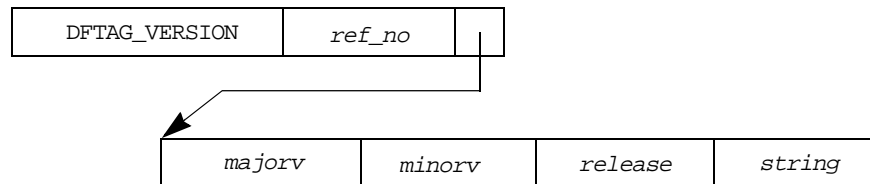

ref_no Reference number (16-bit integer)

majorv Major version number (32-bit integer)

minorv Minor version number (32-bit integer)

release Release number (32-bit integer)

string Non-null terminated ASCII string (any length)

The data portion of this tag contains the complete version number and a descriptive string for the latest version of the HDF library to write to the file.

DFTAG_NT Number type
 4 bytes
 106 (0x006A)

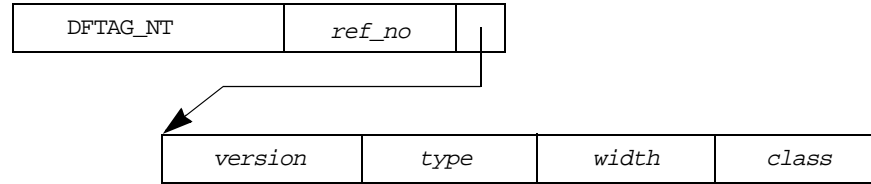

ref_no Reference number (16-bit integer)
version Version number of NT information (8-bit integer)
type Unsigned integer, signed integer, unsigned character, character, floating point, double precision floating point (8-bit code)
width Number of bits, all of which are assumed to be significant (8-bit code)
class A generic value, with different interpretations depending on type: floating point, integer, or character (8-bit code)

Several values that may be used for each of the three types in the field CLASS are listed in Table 9a. This is not an exhaustive list.

TABLE 9a

Number Type Values

Type	Mnemonic	Value
Floating point	DFNTF_NONE	0
	DFNTF_IEEE	1
	DFNTF_VAX	2
	DFNTF_CRAY	3
	DFNTF_PC	4
	DFNTF_CONVEX	5
Integer	DFNTI_MBO	1
	DFNTI_IBO	2
	DFNTI_VBO	4
Character	DFNTC_ASCII1	1
	DFNTC_EBCDOC	2
	DFNTC_BYTE	0

The number type flag is used by any other element in the file to indicate specifically what a numeric value looks like. Other tag types should contain a reference number pointer to a DFTAG_NT instead of containing their own number type definitions.

The version field allows expansion of the number type information, in case some future number types cannot be described using the fields currently defined. Successive versions of the DFTAG_NT

may be substantially different from the current definition, but backward compatibility will be maintained. The current DFTAG_NT version number is 1.

DFTAG_MT Machine type
 0 bytes
 107 (0x006B)

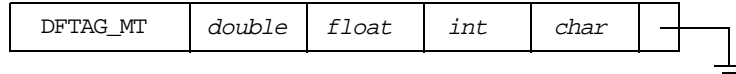

- double* Specifies method of encoding double precision floating point (4-bit code)
- float* Specifies method of encoding single precision floating point (4-bit code)
- int* Specifies method of encoding integers (4-bit code)
- char* Specifies method of encoding characters (4-bit code)

DFTAG_MT specifies that all unconstrained or partially constrained values in this HDF file are of the default type for that hardware. When DFTAG_MT is set to VAX, for example, all integers will be assumed to be in VAX byte order unless specifically defined otherwise with a DFTAG_NT tag. Note that all of the headers and many tags, the whole raster image set for example, are defined with bit-wise precision and will not be overridden by the DFTAG_MT setting.

For DFTAG_MT, the reference field itself is the encoding of the DFTAG_MT information. The reference field is 16 bits, taken as four groups of four bits, specifying the types for double-precision floating point, floating point, integer, and character respectively. This allows 16 generic specifications for each type.

To the user, these will be defined constants in the header file hdf.h, specifying the proper descriptive numbers for Sun, VAX, Cray, Convex, and other computer systems. If there is no DFTAG_MT in a file, the application may assume that the data in the file has been written on the local machine; any portability problems must be addressed by the user. For this reason, we recommend that all HDF files contain a DFTAG_MT for maximum portability.

Currently available data encodings are listed in Table 9b.

TABLE 9b

Available Machine Types

Type	Available Encodings
Double precision floating point	IEEE64 VAX64 CRAY128
Floating point	IEEE32 VAX32 CRAY64

Type	Available Encodings
Integers	VAX32 Intel16 Intel32 Motorola32 CRAY64
Characters	ASCII EBCDIC

New encodings can be added for each data type as the need arises.

9.3.2 Annotation Tags

DFTAG_FID File identifier
String
100 (0x0064)

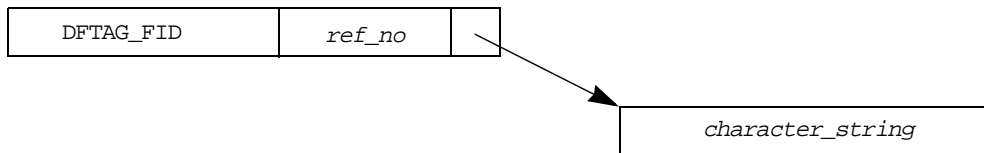

ref_no Reference number (16-bit integer)

character_string
Non-null terminated ASCII text (any length)

This tag points to a string which the user wants to associate with this file. The string is not null terminated. The string is intended to be a user-supplied title for the file.

DFTAG_FD File description
Text
101 (0x0065)

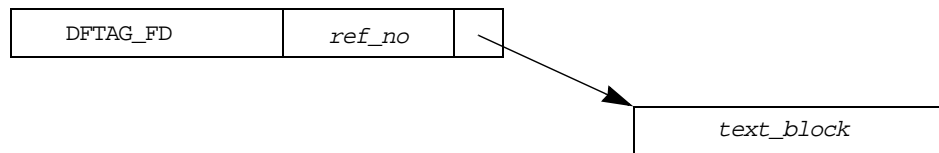

ref_no Reference number (16-bit integer)

text_block Non-null terminated ASCII text (any length)

This tag points to a block of text describing the overall file contents. The text can be any length. The block is not null terminated. The text is intended to be user-supplied comments about the file.

DFTAG_TID Tag identifier
 String
 102 (0x0066)

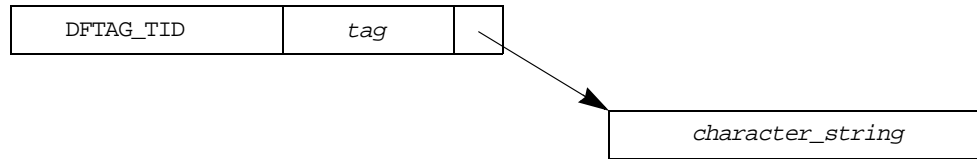

tag Tag number to which this tag refers (16-bit integer)

character_string
 Non-null terminated ASCII text (any length)

The data for this tag is a string that identifies the functionality of the tag indicated in the space normally used for the reference number. For example, the tag identifier for DFTAG_TID might point to data that reads "tag identifier."

Many tags are identified in the HDF specification, so it is usually unnecessary to include their identifiers in the HDF file. But with user-defined tags or special-purpose tags, the only way for a human reader to diagnose what kind of data is stored in a file is to read tag identifiers. Use tag descriptions to define even more detail about your user-defined tags.

Note that with this tag you may make use of the user-defined tags to check for consistency. Although two persons may use the same user-defined tag, they probably will not use the same tag identifier.

DFTAG_TD Tag description
 Text
 103 (0x0067)

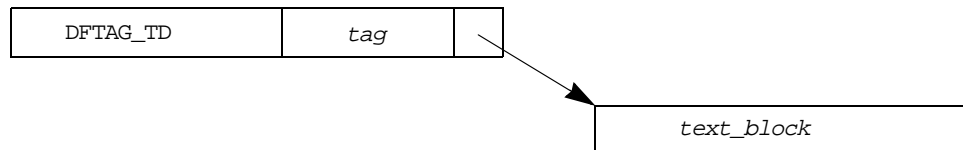

tag Tag number to which this tag refers (16-bit integer)

text_block Non-null terminated ASCII text (any length)

The data for this tag is a text block which describes in relative detail the functionality and format of the tag which is indicated in the space normally occupied by the reference number. This tag is intended to be used with user-defined tags and provides a medium for users to exchange files that include human-readable descriptions of the data.

It is important to provide everything that a programmer might need to know to read the data from your user-defined tag. At the minimum, you should specify everything you would need to know in order to retrieve your data at a later date if the original program were lost.

DFTAG_DIL Data identifier label
String
104 (0x0068)

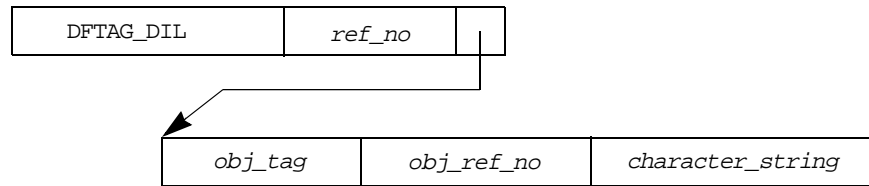

ref_no Reference number (16-bit integer)
obj_tag Tag number of the data to which this label applies (16-bit integer)
obj_ref_no Reference number of the data object to which this label applies (16-bit integer)
character_string
Non-null terminated ASCII text (any length)

The DFTAG_DIL data object consists of a tag/ref followed by a string. The string serves as a label for the data identified by the tag/ref.

By including DFTAG_DIL tags, you can give a data object a label for future reference. For example, DFTAG_DIL can be used to assign titles to images.

DFTAG_DIA Data identifier annotation
Text
105 (0x0069)

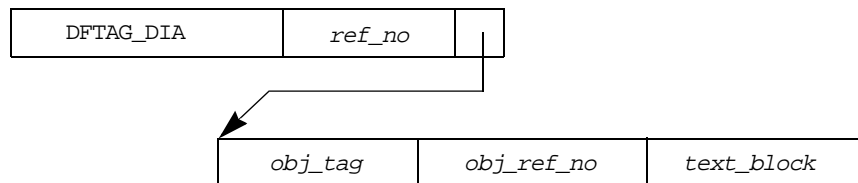

ref_no Reference number (16-bit integer)
obj_tag Tag number of the data to which this annotation applies (16-bit integer)
obj_ref_no Reference number of the data object to which this annotation applies (16-bit integer)
text_block Non-null terminated ASCII text (any length)

The DFTAG_DIA data object consists of a tag/ref followed by a text block. The text block serves as an annotation of the data identified by the tag/ref.

With a DFTAG_DIA tag, any data object can have a lengthy, user-written description. This can be used to include comments about images, data sets, source code, and so forth.

9.3.3 Compression Tags

DFTAG_RLE Run length encoded data
 0 bytes
 11 (0x000B)

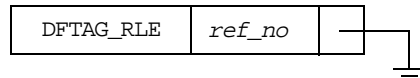

ref_no Reference number (16-bit integer)

This tag is used in the DFTAG_ID compression field and in other places to indicate that an image or section of data is encoded with a run-length encoding scheme. The RLE method used is byte-wise. Each run is preceded by a count byte. The low seven bits of the count byte indicate the number of bytes (*n*). The high bit of the count byte indicates whether the next byte should be replicated *n* times (high bit = 1), or whether the next *n* bytes should be included as is (high bit = 0).

See also: DFTAG_ID in “Raster Image Tags”
 DFTAG_NDG in “Scientific Data Set Tags”

DFTAG_IMC IMCOMP compressed data
 0 bytes
 12 (0x000C)

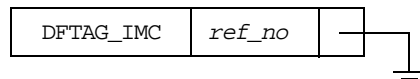

ref_no Reference number (16-bit integer)

This tag is used in the DFTAG_ID compression field and in other places to indicate that an image or section of data is encoded with an IMCOMP encoding scheme. This scheme is a 4:1 aerial averaging method which is easy to decompress. It counts color frequencies in 4x4 squares to optimize color sampling.

See also: DFTAG_ID in “Raster Image Tags”
 DFTAG_NDG in “Scientific Data Set Tags”

DFTAG_JPEG 24-bit JPEG compression information
 ? bytes
 13 (0x000D)

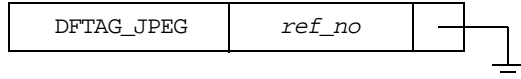

ref_no Reference number (16-bit integer)

This tag is a flag indicating that the corresponding compressed object is a 24-bit JPEG image. The DFTAG_JPEG flag and the corresponding DFTAG_CI object will share the same reference number.

DFTAG_GREYJPEG 8-bit JPEG compression information
 ? bytes
 14 (0x000E)

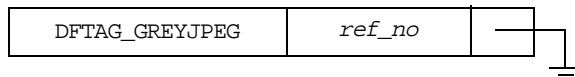

ref_no Reference number (16-bit integer)

This tag is a flag indicating that the corresponding compressed object is an 8-bit JPEG image. The DFTAG_GREYJPEG flag and the corresponding DFTAG_CI object will share the same reference number.

DFTAG_CI Compressed raster image
 ? bytes
 303 (0x012F)

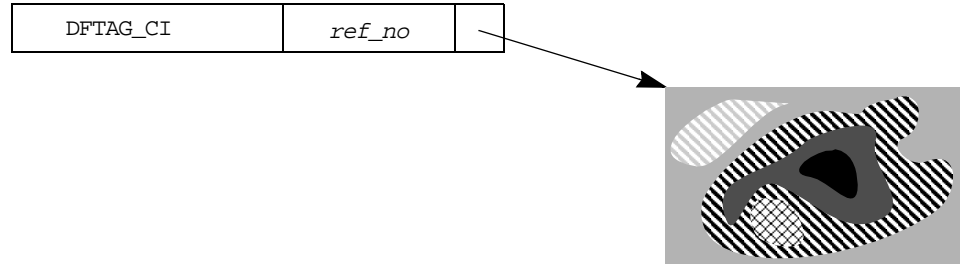

ref_no Reference number (16-bit integer)

This tag points to a stream of bytes that make up a compressed image. The type of compression, together with any necessary parameters, are stored as a separate data object. For example, if DFTAG_JPEG is contained in the same raster image group, the stream of bytes contains the JFIF header and all further data for the JPEG image. Other parameters are stored in the DFTAG_JPEG object.

The **JFIF header** is the header data stored in a JFIF (JPEG File Interchange Format) file up to the start-of-frame parameter. See the document *JPEG File Interchange Format*¹ for a detailed description of the file format.

1. The document *JPEG File Interchange Format* has not been published in a regular periodical. An electronic copy is available as a Postscript file from NCSA's FTP server <ftp.ncsa.uiuc.edu> in the same directory as this document, *NCSA HDF Specification and Developer's Guide*. Printed copies are available from C-Cube Microsystems, 1778 McCarthy Boulevard, Milpitas, CA 95035 (phone: 408-944-6300. Fax: 408-944-6314. Current email contact: eric@c3.pla.ca.us).

9.3.4 Raster Image Tags

DFTAG_RIG Raster image group
 $n*4$ bytes (where n is the number of data objects in the group)
 306 (0x0132)

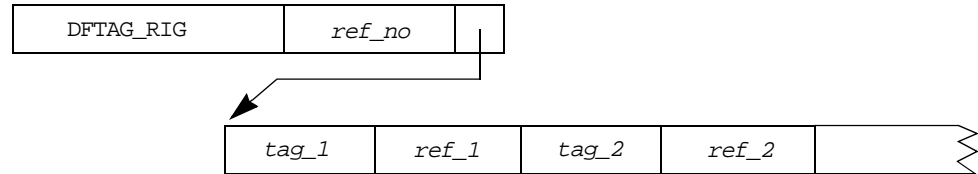

ref_no Reference number (16-bit integer)
tag_n Tag number for n^{th} member of the group (16-bit integer)
ref_n Reference number for n^{th} member of the group (16-bit integer)

The RIG data element contains the tag/refs of all the data objects required to display a raster image correctly. Application programs that deal with RIGs should read all the elements of a RIG and process those identifiers which it can display correctly. Even if the application cannot process *all* of the objects, the objects that it can process will be usable.

Table 9c lists the tags that may appear in an RIG.

TABLE 9c

Available RIG Tags

Tag	Description
DFTAG_ID	Image dimension record
DFTAG_RI	Raster image
DFTAG_XYP	X-Y position
DFTAG_LD	LUT dimension
DFTAG_LUT	Color lookup table
DFTAG_MD	Matte channel dimension
DFTAG_MA	Matte channel
DFTAG_CCN	Color correction
DFTAG_CFM	Color format
DFTAG_AR	Aspect ratio

Example

DFTAG_ID, DFTAG_RI, DFTAG_LD, DFTAG_LUT

Assume that an image dimension record, a raster image, an LUT dimension record, and an LUT are all required to display a particular raster image correctly. These data objects can be associated in an RIG so that an application can read the image dimensions then the image. It will then read the lookup table and display the image.

DFTAG_ID	Image dimension 20 bytes 300 (0x012C)
DFTAG_LD	LUT dimension 20 bytes 307 (0x0133)
DFTAG_MD	Matte dimension 20 bytes 308 (0x0134)

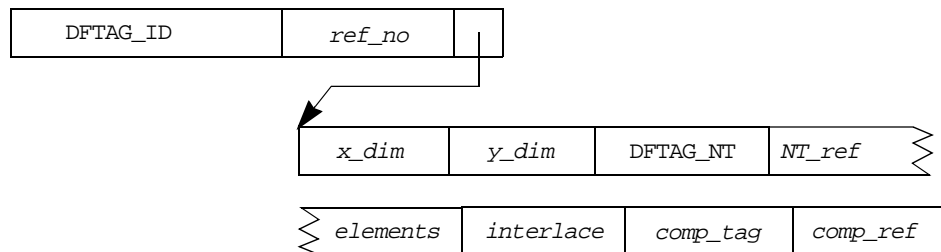

<i>ref_no</i>	Reference number (16-bit integer)
<i>x_dim</i>	Length of x (horizontal) dimension (32-bit integer)
<i>y_dim</i>	Length of y (vertical) dimension (32-bit integer)
<i>NT_ref</i>	Reference number for number type information
<i>elements</i>	Number of elements that make up one entry (16-bit integer)
<i>interlace</i>	Type of interlacing used (16-bit integer)
0	The components of each pixel are together.
1	Color elements are grouped by scan lines.
2	Color elements are grouped by planes.
<i>comp_tag</i>	Tag which tells the type of compression used and any associated parameters (16-bit integer)
<i>comp_ref</i>	Reference number of compression tag (16-bit integer)

These three dimension records have exactly the same format; they specify the dimensions of the 2-dimensional arrays after which they are named and provide information regarding other attributes of the data in the array:

- DFTAG_ID specifies the dimensions of a DFTAG_RI .
- DFTAG_LD specifies the dimensions of a DFTAG_LUT.
- DFTAG_MD specifies the dimensions of a DFTAG_MA.

Other attributes described in the image dimension record include the number type of the elements, the number of elements per pixel, the interlace scheme used, and the compression scheme used (if any).

For example, a 512x256 row-wise 24-bit raster image with each pixel stored as RGB bytes would have the following values:

```

x_dim      512
y_dim      256
NT_ref     UINT8
elements   3 (3 elements per pixel: e.g., R, G, and B)
interlace  0 (RGB values not separated)
comp_tag   0 (no compression is used)

```

The diagram above illustrates the tag `DFTAG_ID`. The `DFTAG_LD` and `DFTAG_MD` diagrams would be identical except for the tag name in the first cell, which would be `DFTAG_LD` and `DFTAG_MD`, respectively.

`DFTAG_RI` Raster image
 $xdim * ydim * elements * NTsize$ bytes ($xdim$, $ydim$, $elements$,
and $NTsize$ are specified in the corresponding `DFTAG_ID`)
302 (0x012E)

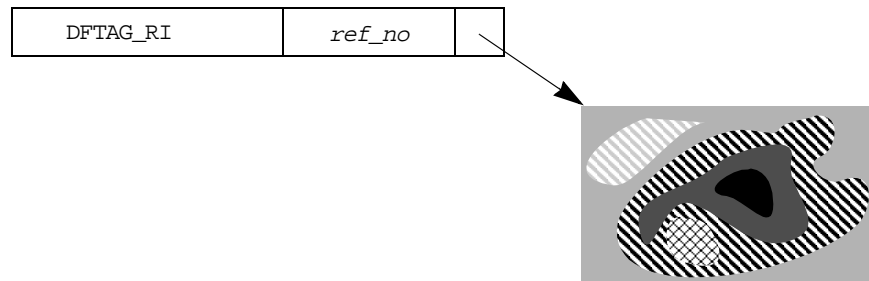

ref_no Reference number (16-bit integer)

This tag points to raster image data. It is stored in row-major order and must be interpreted as specified by *interlace* in the related `DFTAG_ID`.

DFTAG_LUT

Lookup table

$xdim * ydim * elements * NTsize$ bytes ($xdim$, $ydim$, $elements$, and $NTsize$ are specified in the corresponding DFTAG_ID)
 301 (0x012D)

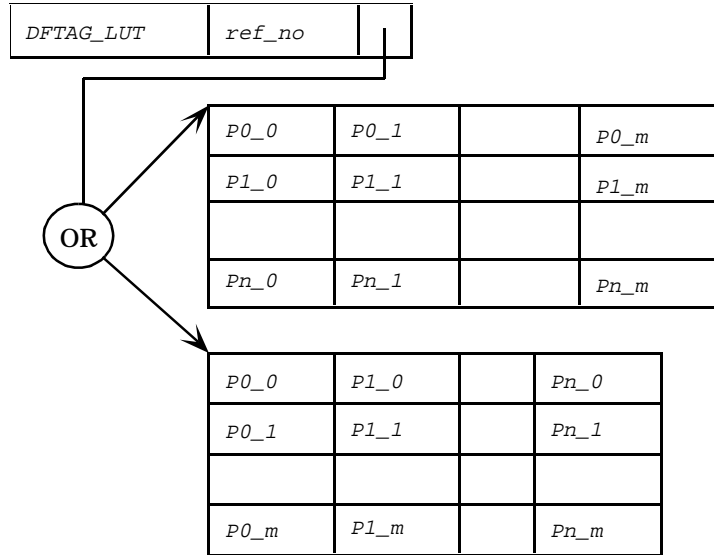

ref_no Reference number (16-bit integer)

Pn_m m^{th} value of parameter n (size is specified by the DFTAG_NT in the corresponding DFTAG_LD)

The DFTAG_LUT, sometimes called a palette, is used to assign colors to data values. When a raster image consists of data values which are going to be interpreted through an LUT capability, the DFTAG_LUT should be loaded along with the image.

The most common lookup table is the RGB lookup table which will have X dimension = 256 and Y dimension = 1 with three elements per entry, one each for red, green, and blue. The interlace will be either 0, where the LUT values are given RGB, RGB, RGB, ..., or 1, where the LUT values are given as 256 reds, 256 greens, 256 blues.

DFTAG_MA

Matte channel

$xdim * ydim * elements * NTsize$ bytes ($xdim$, $ydim$, $elements$, and $NTsize$ are specified in the corresponding DFTAG_ID) 309 (0x0135)

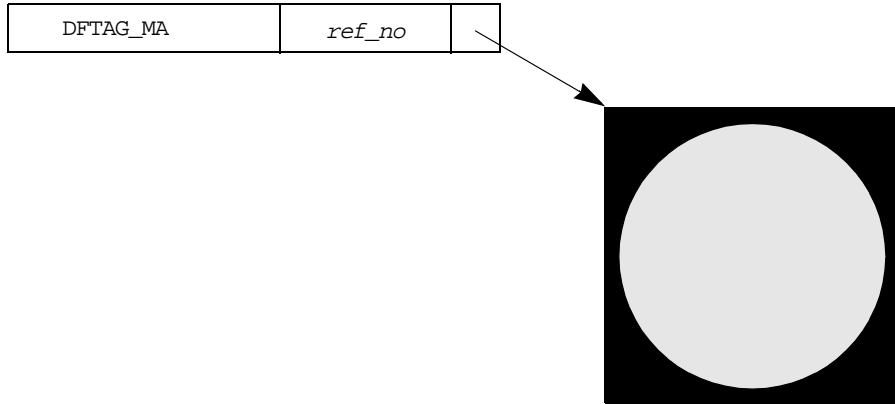

ref_no Reference number (16-bit integer)

The DFTAG_MA data object contains transparency data which can be used to facilitate the overlaying of images. The data consists of a 2-dimensional array of unsigned 8-bit integers ranging from 0 to 255. Each point in a DFTAG_MA indicates the transparency of the corresponding point in a raster image of the same dimensions. A value of 0 indicates that the data at that point is to be considered totally transparent, while a value of 255 indicates that the data at that point is totally opaque. It is assumed that a linear scale applies to the transparency values, but users may opt to interpret the data in any way they wish.

DFTAG_CCN Color correction
 52 bytes (usually)
 310 (0x0136)

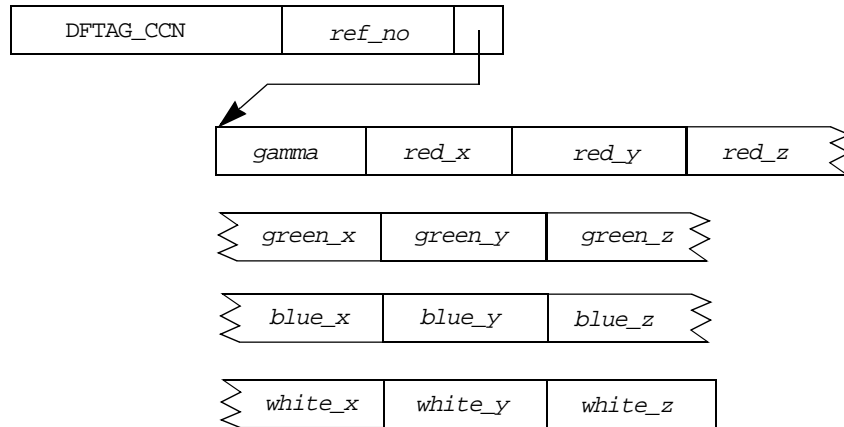

ref_no Reference number (16-bit integer)

gamma Gamma parameter (32-bit IEEE floating point)

red_x, *red_y*, and *red_z*
 Red x, y, and z correction factors (32-bit IEEE floating point)

green_x, *green_y*, and *green_z*
 Green x, y, and z correction factors (32-bit IEEE floating point)

blue_x, *blue_y*, and *blue_z*
 Blue x, y, and z correction factors (32-bit IEEE floating point)

white_x, *white_y*, and *white_z*
 White x, y, and z correction factors (32-bit IEEE floating point)

Color correction specifies the Gamma correction for the image and color primaries for the generation of the image.

DFTAG_CFM Color format
 String
 311 (0x0137)

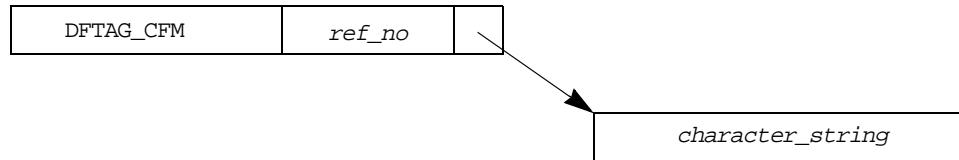

ref_no Reference number (16-bit integer)

character_string Non-null terminated ASCII string (any length)

The color format data element contains a string of uppercase characters that indicates how each element of each pixel in a raster image is to be interpreted. Table 9d lists the available color format strings.

TABLE 9d

Color Format String Values

String	Description
VALUE	Pseudo-color, or just a value associated with the pixel
RGB	Red, green, blue model
XYZ	Color-space model
HSV	Hue, saturation, value model
HSI	Hue, saturation, intensity
SPECTRAL	Spectral sampling method

DFTAG_AR Aspect ratio
 4 bytes
 312 (0x0138)

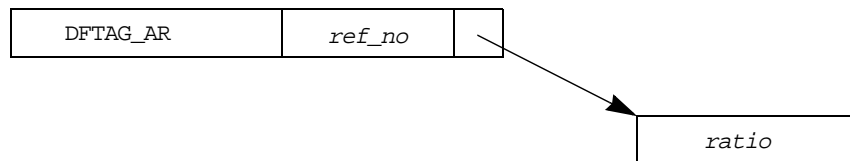

ref_no Reference number (16-bit integer)

ratio Ratio of width to height (32-bit IEEE float)

The data for this tag is the visual aspect ratio for this image. The image should be visually correct if displayed on a screen with this aspect ratio. The data consists of one floating-point number which represents width divided by height. An aspect ratio of 1.0 indicates a display with perfectly square pixels; 1.33 is a standard aspect ratio used by many monitors.

9.3.5 Composite Image Tags

DFTAG_DRAW Draw
 $n*4$ bytes (where n is the number of data objects that make up the composite image)
 400 (0x0190)

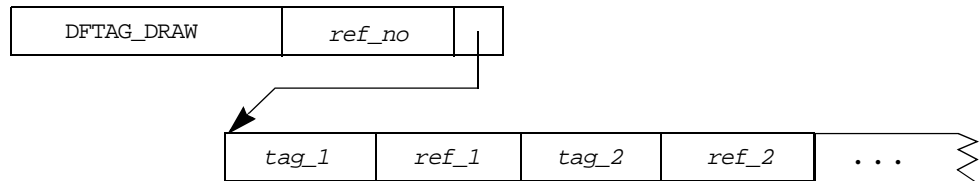

ref_no Reference number (16-bit integer)

tag_n Tag number of the n^{th} member of the draw list (16-bit integer)

ref_n Reference number of the n^{th} member of the draw list (16-bit integer)

The **DFTAG_DRAW** data element consists of a list of tag/refs that define a composite image. The data objects indicated should be displayed in order. This can include several RIGs which are to be displayed simultaneously. It can also include vector overlays, like **DFTAG_T14**, which are to be placed on top of an RIG.

Some of the elements in a **DFTAG_DRAW** list may be instructions about how images are to be composited (XOR, source put, anti-aliasing, etc.). These are defined as individual tags.

DFTAG_XYP XY position
 8 bytes
 500 (0x01F4)

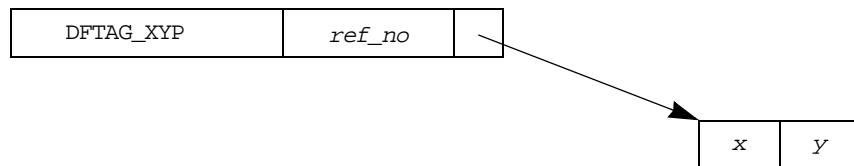

ref_no Reference number (16-bit integer)

x X-coordinate (32-bit integer)

y Y-coordinate (32-bit integer)

DFTAG_XYP is used in composites and other groups to indicate an XY position on the screen. For this, (0,0) is the lower left corner of the print area. X is the number of pixels to the right along the horizontal axis and Y is the number of pixels up on the vertical axis. The X and Y coordinates are two 32-bit integers.

For example, if **DFTAG_XYP** is present in a **DFTAG_RIG**, the **DFTAG_XYP** specifies the position of the lower left corner of the raster image on the screen.

See also: DFTAG_DRAW in this section

9.3.6 Vector Image Tags

DFTAG_T14 Tektronix 4014
? bytes
602 (0x25A)

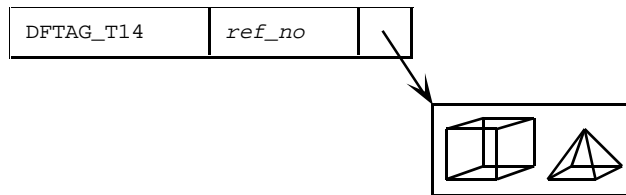

ref_no Reference number (16-bit integer)

This tag points to a Tektronix 4014 data stream. The bytes in the data field, when read and sent to a Tektronix 4014 terminal, will display a vector image. Only the lower seven bits of each byte are significant. There are no record markings or non-Tektronix codes in the data.

DFTAG_T105 Tektronix 4105
? bytes
603 (0x25B)

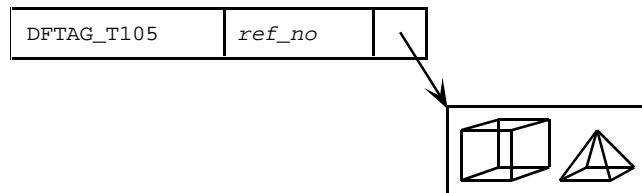

ref_no Reference number (16-bit integer)

This tag points to a Tektronix 4105 data stream. The bytes in the data field, when read and sent to a Tektronix 4105 terminal, will be displayed as a vector image. Only the lower seven bits of each byte are significant. Some terminal emulators will not correctly interpret every feature of the Tektronix 4105 terminal, so you may wish to use only a subset of the available Tektronix 4105 vector commands.

9.3.7 Scientific Data Set Tags

DFTAG_NDG Numeric data group
 $n*4$ bytes (where n is the number of data objects in the group.)
 720 (0x02D0)

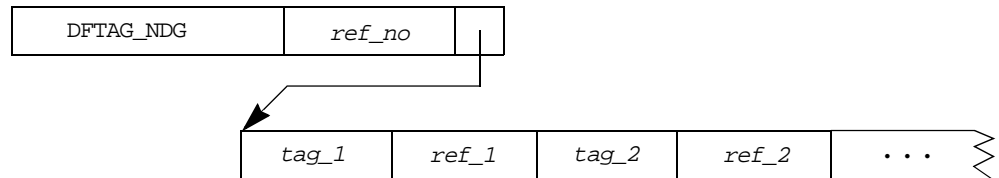

ref_no Reference number (16-bit integer)
tag_n Tag number of n^{th} member of the group (16-bit integer)
ref_n Reference number of n^{th} member of the group
 (16-bit integer)

The NDG data contains a list of tag/refs that define a scientific data set. DFTAG_NDG supersedes the old DFTAG_SDG, which became obsolete upon the release on HDF Version 3.2. A more complete explanation of the relationship between DFTAG_NDG and DFTAG_SDG can be found in Chapter 5, “Sets and Groups.”

All of the members of an NDG provide information for correctly interpreting and displaying the data. Application programs that deal with NDGs should read all of the elements of a NDG and process those data objects which it can use. Even if an application cannot process all of the objects, the objects that it can understand will be usable.

Table 9e lists the tags that may appear in an NDG.

TABLE 9e

Available NDG Tags

Tag	Description
DFTAG_SDD	Scientific data dimension record (rank and dimensions)
DFTAG_SD	Scientific data
DFTAG_SDS	Scales
DFTAG_SDL	Labels
DFTAG_SDU	Units
DFTAG_SDF	Formats
DFTAG_SDM	Maximum and minimum values
DFTAG_SDC	Coordinate system
DFTAG_CAL	Calibration information
DFTAG_FV	Fill value
DFTAG_LUT	Color lookup table
DFTAG_LD	Lookup table dimension record
DFTAG_SDLNK	Link to old-style DFTAG_SDG

Example

DFTAG_SDD, DFTAG_SD, DFTAG_SDM

Suppose that an NDG contains a dimension record, scientific data, and the maximum and minimum values of the data. These data objects can be associated in an NDG so that an application can read the rank and dimensions from the dimension record and then read the data array. If the application needs maximum and minimum values, it will read them as well.

See also: Chapter 5, "Sets and Groups"

DFTAG_SDD Scientific data dimension record
 6 + 8*rank bytes
 701 (0x02BD)

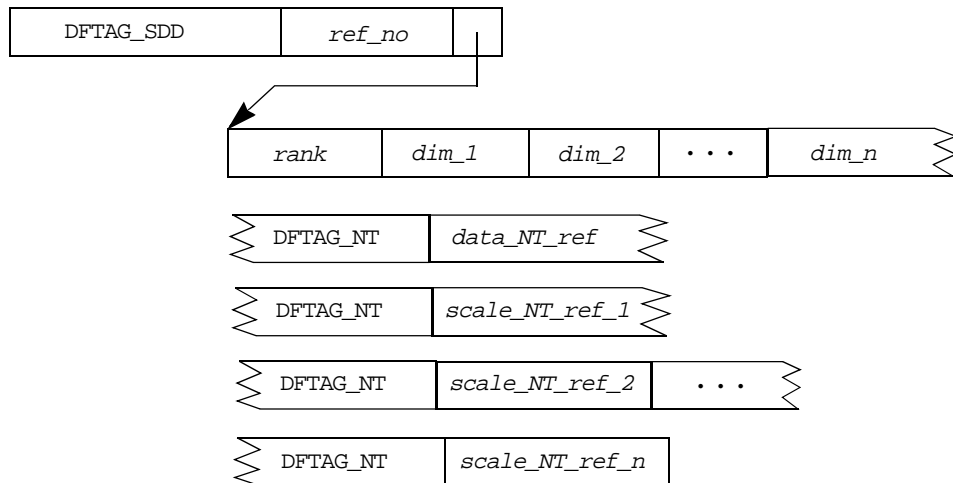

ref_no Reference number (16-bit integer)
rank Number of dimensions (16-bit integer)
dim_n Number of values along the nth dimension (32-bit integer)
data_NT_ref Reference number of DFTAG_NT for data
 (16-bit integer)
scale_NT_ref_n
 Reference number for DFTAG_NT for the scale for the nth dimension (16-bit integer)

This record defines the rank and dimensions of the array in the scientific data set. For example, a DFTAG_SDD for a 500x600x3 array of floating-point numbers would have the following values and components.

- Rank: 3
- Dimensions: 500, 600, and 3.
- One data NT
- Three scale NTs

DFTAG_SD

Scientific data

$NTsize * x * y * z * \dots$ bytes (where $NTsize$ is the size of the data NT specified in the corresponding $DFTAG_SDD$ and x, y, z, \dots are the dimension sizes)

702 (0x02BE)

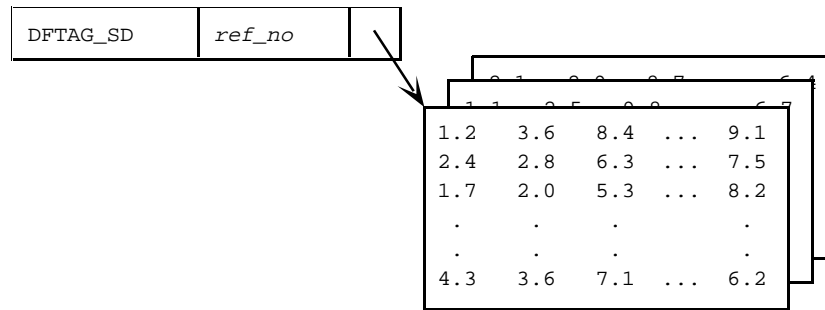

ref_no Reference number (16-bit integer)

This tag points to an array of scientific data. The type of the data may be specified by an $DFTAG_NT$ included with the SDG. If there is no $DFTAG_NT$, the type of the data is floating-point in standard IEEE 32-bit format. The rank and dimensions must be stored as specified in the corresponding $DFTAG_SDD$. The diagram above shows a 3-dimensional data array.

DFTAG_SDS

Scientific data scales

$rank + N\text{Size}_0 * x + N\text{Size}_1 * y + N\text{Size}_2 * z + \dots$ bytes (where *rank* is the number of dimensions, *x*, *y*, *z*, etc. are the dimension sizes, and *NSize#* are the sizes of each scale NT from the corresponding DFTAG_SDD)

703 (0x02BF)

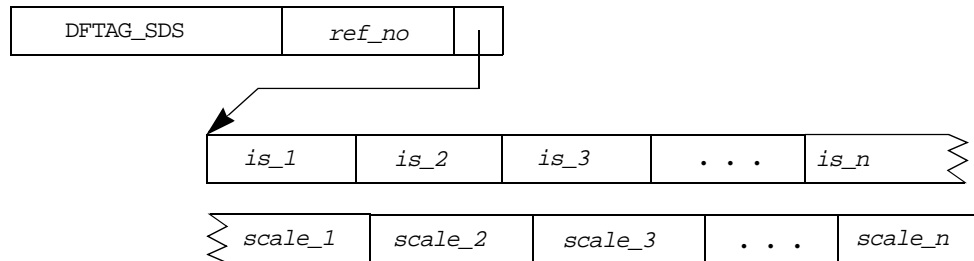

ref_no Reference number (16-bit integer)

is_n A flag indicating whether a scale exists for the *n*th dimension (8-bit integer; 0 or 1)

scale_n List of scale values for the *n*th dimension (type specified in corresponding DFTAG_SDD)

This tag points to the scales for the data set. The first *n* bytes indicate whether there is a scale for the corresponding dimension (1 = yes, 0 = no). This is followed by the scale values for each dimension. The scale consists of a simple series of values where the number of values and their types are specified in the corresponding DFTAG_SDD.

DFTAG_SDL

Scientific data labels

? bytes

704 (0x02C0)

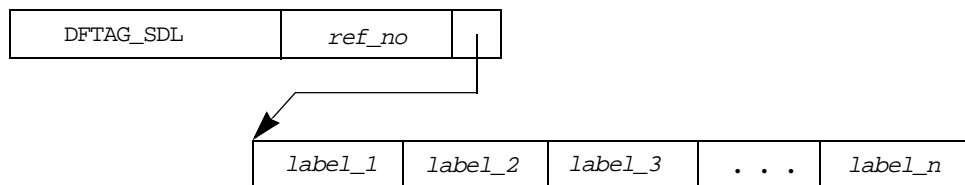

ref_no Reference number (16-bit integer)

label_n Null terminated ASCII string (any length)

This tag points to a list of labels for the data in each dimension of the data set. Each label is a string terminated by a null byte (0).

DFTAG_SDU Scientific data units
 ? bytes
 705 (0x02C1)

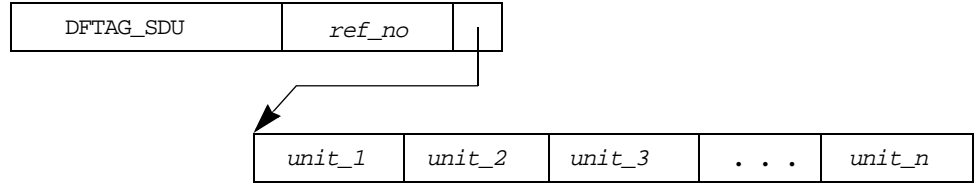

ref_no Reference number (16-bit integer)

unit_n Null terminated ASCII string (any length)

This tag points to a list of strings specifying the units for the data and each dimension of the data set. Each unit's string is terminated by a null byte (0).

DFTAG_SDF Scientific data format
 ? bytes
 706 (0x02C2)

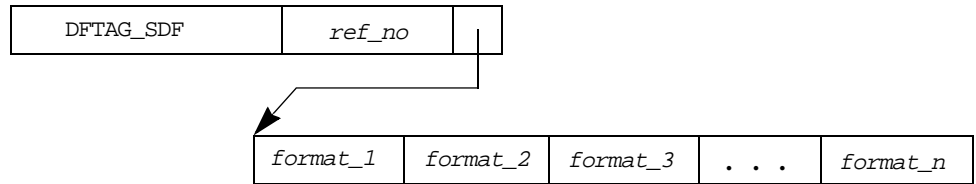

ref_no Reference number (16-bit integer)

format_n Null terminated ASCII string (any length)

This tag points to a list of strings specifying an output format for the data and each dimension of the data set. Each format string is terminated by a null byte (0).

DFTAG_SDM Scientific data max/min
 8 bytes
 707 (0x02C3)

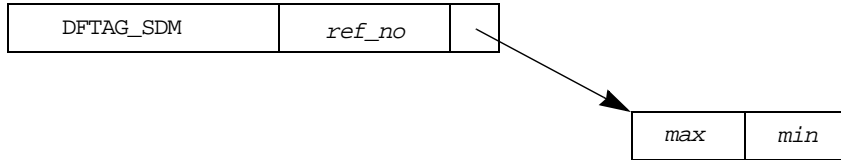

ref_no Reference number (16-bit integer)
max Maximum value (type is specified by the data NT in the corresponding DFTAG_SDD)
min Minimum value (type is specified by the data NT in the corresponding DFTAG_SDD)

This record contains the maximum and minimum data values in the data set. The type of *max* and *min* are specified by the data NT of the corresponding DFTAG_SDD.

DFTAG_SDC Scientific data coordinates
 ? bytes
 708 (0x02C4)

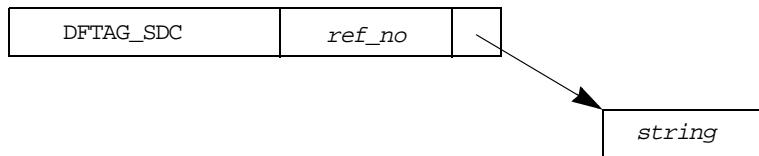

ref_no Reference number (16-bit integer)
string Null terminated ASCII string (any length)

This tag points to a string specifying the coordinate system for the data set. The string is terminated by a null byte.

DFTAG_SDLNK Scientific data set link
 8 bytes
 710 (0x02C6)

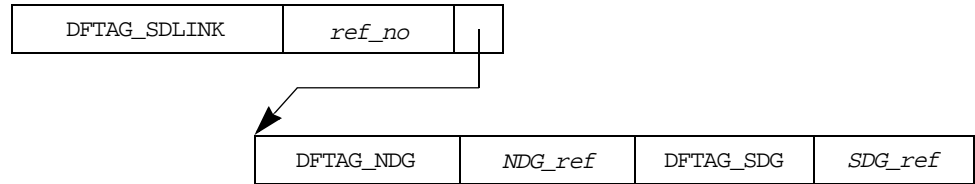

ref_no Reference number (16-bit integer)
 DFTAG_NDG NDG tag (16-bit integer)
NDG_ref NDG reference number (16-bit integer)
 DFTAG_SDG SDG tag (16-bit integer)
SDG_ref SDG reference number (16-bit integer)

The purpose of this tag is to link together an old-style DFTAG_SDG and a DFTAG_NDG in cases where the NDG contains 32-bit floating point data and is, therefore, equivalent to an old SDG.

See also: Chapter 5, "*Sets and Groups*"

DFTAG_CAL Calibration information
 36 bytes
 731 (0x02DB)

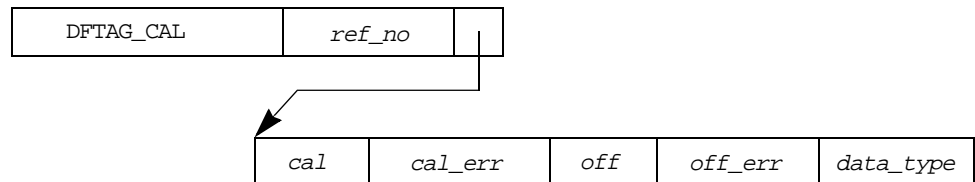

ref_no Reference number (16-bit integer)
cal Calibration factor (64-bit IEEE float)
cal_err Error in calibration factor (64-bit IEEE float)
off Calibration offset (64-bit IEEE float)
off_err Error in calibration offset (64-bit IEEE float)
data_type Constant representing the effective data type of the calibrated data (32-bit integer)

This tag points to a calibration record for the associated DFTAG_SD. The data can be calibrated by first multiplying by the *cal* factor, then adding the *off* value. Also included in the record are errors for the calibration factor and offset and a constant indicating the effective data type of the calibrated data. Table 9f lists the available *data_type* values.

TABLE 9f

Available Calibrated Data Types

Data Type	Description
DFTNT_INT8	Signed 8-bit integer
DFTNT_UINT8	Unsigned 8-bit integer
DFTNT_INT16	Signed 16-bit integer
DFTNT_UINT16	Unsigned 16-bit integer
DFTNT_INT32	Signed 32-bit integer
DFTNT_UINT32	Unsigned 32-bit integer
DFTNT_FLOAT32	32-bit floating point
DFTNT_FLOAT64	64-bit floating point

DFTAG_FV Fill value
 ? bytes (size determined by size of data NT in corresponding
 DFTAG_SDD)
 732 (0x02DC)

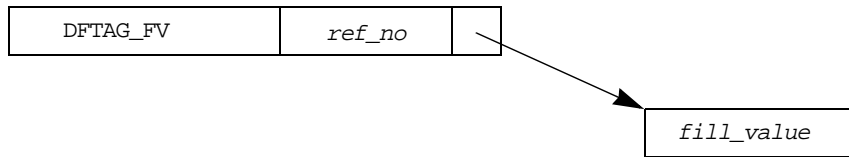

ref_no Reference number (16-bit integer)

fill_value Value representing unset data in the corresponding DFTAG_SD (size determined by size of data NT in corresponding DFTAG_SDD)

This tag points to a value which has been used to indicate unset values in the associated DFTAG_SD. The number type of the value (and, therefore, its size) is given in the corresponding DFTAG_SDD.

9.3.8 Vset Tags

DFTAG_VG Vgroup
 14 + 4**nelt* + *namelen* + *classlen* bytes
 1965 (0x07AD)

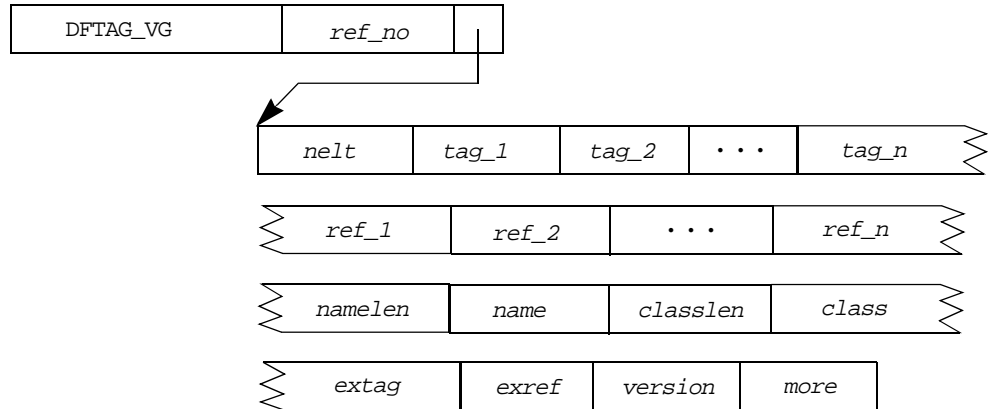

ref_no Reference number (16-bit integer)
nelt Number of elements in the Vgroup (16-bit integer)
tag_n Tag of the *n*th member of the Vgroup (16-bit integer)
ref_n Reference number of the *n*th member of the Vgroup (16-bit integer)
namelen Length of the name field (16-bit integer)
name Non-null terminated ASCII string (length given by *namelen*)
classlen Length of the class field (16-bit integer)
class Non-null terminated ASCII string (length given by *classlen*)
extag Extension tag (16-bit integer)
exref Extension reference number (16-bit integer)
version Version number of DFTAG_VG information (16-bit integer)
more Unused (2 zero bytes)

DFTAG_VG provides a general-purpose grouping structure which can be used to impose a hierarchical structure on the tags in the group. Any HDF tag may be incorporated into a Vgroup, including other DFTAG_VG tags.

See also: “Vsets, Vdatas, and Vgroups” in Chapter 5, “Sets and Groups”

NCSA HDF Vsets, Version 2.0 for HDF Versions 3.2 and earlier

HDF User's Guide and *HDF Reference Manual* for Versions 3.3 and 4.x

DFTAG_VH

Vdata description
 $22 + 10 * nfields + \sum fldnmlen_n + namelen + classlen$ bytes
 1962 (0x07AA)

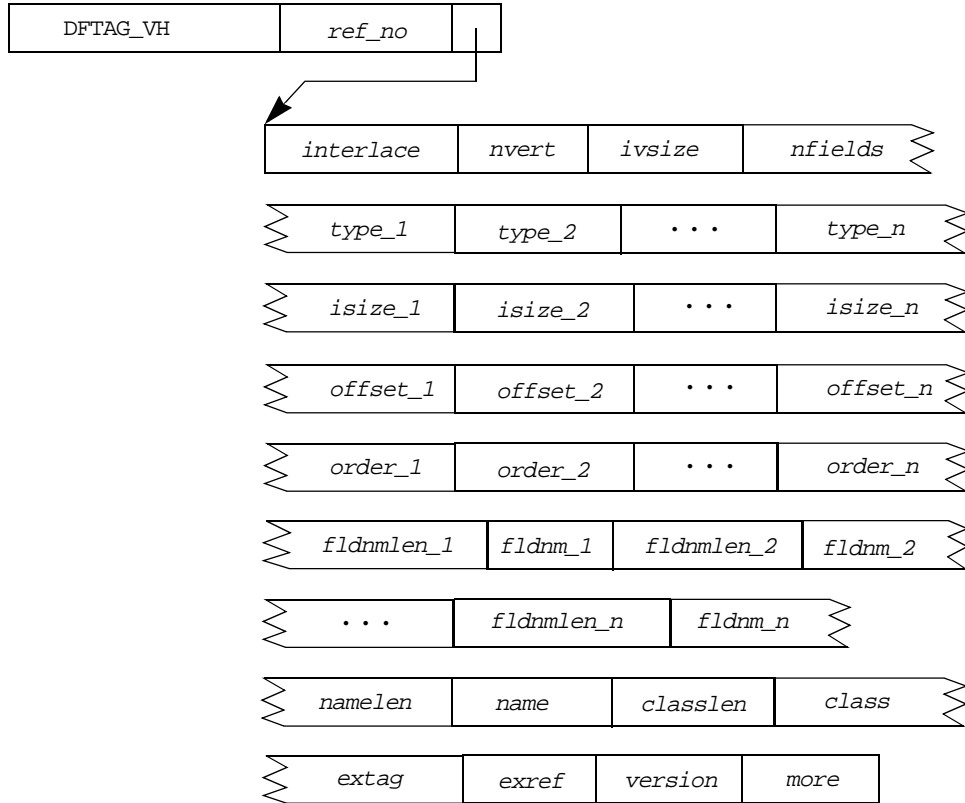

- ref_no* Reference number (16-bit integer)
- interlace* Constant indicating interlace scheme used (16-bit integer)
- nvert* Number of entries in Vdata (32-bit integer)
- ivsize* Size of one Vdata entry (16-bit integer)
- nfields* Number of fields per entry in the Vdata (16-bit integer)
- type_n* Constant indicating the data type of the nth field of the Vdata (16-bit integer)

<i>isize_n</i>	Size in bytes of the n th field of the Vdata (16-bit integer)
<i>offset_n</i>	Offset of the n th field within the Vdata (16-bit integer)
<i>order_n</i>	Order of the n th field of the Vdata (16-bit integer)
<i>fldnmlen_n</i>	Length of the n th field name string (16-bit integer)
<i>fldnm_n</i>	Non-null terminated ASCII string (length given by corresponding <i>fldnmlen_n</i>)
<i>namelen</i>	Length of the name field (16-bit integer)
<i>name</i>	Non-null terminated ASCII string (length given by <i>namelen</i>)
<i>classlen</i>	Length of the class field (16-bit integer)
<i>class</i>	Non-null terminated ASCII string (length given by <i>classlen</i>)
<i>extag</i>	Extension tag (16-bit integer)
<i>exref</i>	Extension reference number (16-bit integer)
<i>version</i>	Version number of DFTAG_VH information (16-bit integer)
<i>more</i>	Unused (2 zero bytes)

DFTAG_VH provides all the information necessary to process a DFTAG_VS.

See also: DFTAG_VS (this section)
“Vsets, Vdatas, and Vgroups” in Chapter 5, “*Sets and Groups*”
NCSA HDF Vsets, Version 2.0 for HDF Versions 3.2 and earlier
HDF User's Guide and *HDF Reference Manual* for Versions 3.3 and 4.x

DFTAG_VS

Vdata

$$nvert * \sum_{n=1}^{nfields} (isize_n * order_n) \text{ bytes where}$$

nvert, *isize_n*, and *order_n* are specified in the corresponding DFTAG_VH 1963 (0x07AB)

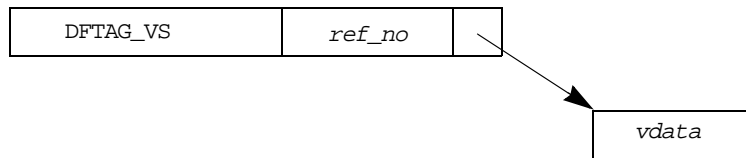

ref_no Reference number (16-bit integer)

vdata Data block interpreted according to the corresponding DFTAG_VH (value of the summation above, where *nvert*, *isize_n*, and *order_n* are specified in the corresponding DFTAG_VH)

DFTAG_VS contains a block of data which is to be interpreted according to the information in the corresponding DFTAG_VH.

See also: DFTAG_VH (this section)

“Vsets, Vdatas, and Vgroups” in Chapter 5, “Sets and Groups”

NCSA HDF Vsets, Version 2.0 for HDF Versions 3.2 and earlier

HDF User’s Guide and *HDF Reference Manual* for Versions 3.3 and 4.x

9.3.9 Obsolete Tags

DFTAG_ID8 Image dimension-8
 4 bytes
 200 (0x00C8)

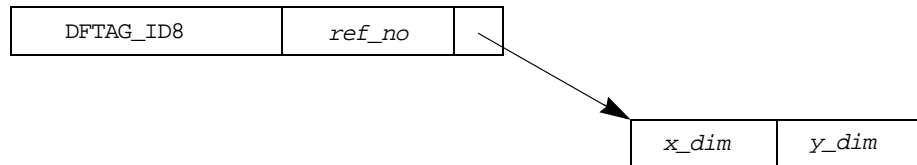

ref_no Reference number (16-bit integer)
x_dim Length of x dimension (16-bit integer)
y_dim Length of y dimension (16-bit integer)

The data for this tag consists of two 16-bit integers representing the width and height of an 8-bit raster image in bytes.

This tag has been superseded by DFTAG_ID.

DFTAG_IP8 Image palette-8
 768 bytes
 201 (0x00C9)

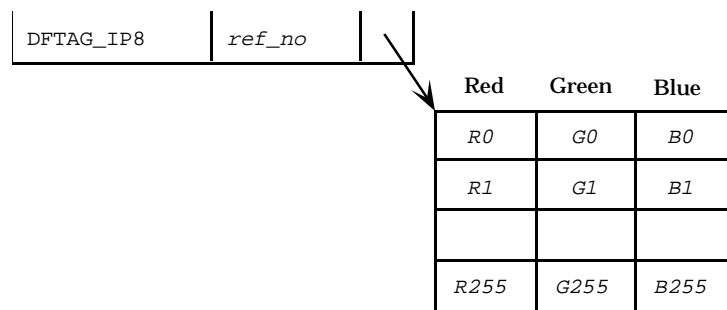

ref_no Reference number (16-bit integer)
 Table entries 256 triples of 8-bit integers

The data for this tag can be thought of as a table of 256 entries, each containing one value for red, green, and blue. The first triple is palette entry 0 and the last is palette entry 255.

This tag has been superseded by DFTAG_LUT.

DFTAG_RI8 Raster image-8
*xdim***ydim* bytes (where *xdim* and *ydim* are the dimensions
 specified in the corresponding DFTAG_ID8)
 202 (0x00CA)

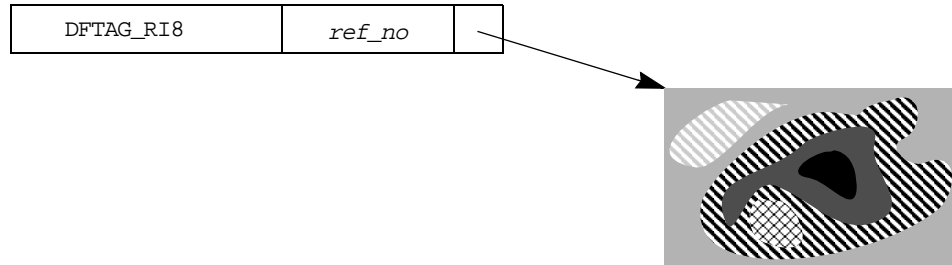

ref_no Reference number (16-bit integer)
 Image data 2-dimensional array of 8-bit integers

The data for this tag is a row-wise representation of the elementary 8-bit image data. The data is stored width-first (i.e., row-wise) and is 8 bits per pixel. The first byte of data represents the pixel in the upper-left hand corner of the image.

This tag has been superseded by DFTAG_RI.

DFTAG_CI8 Compressed image-8
 ? bytes
 203 (0x00CB)

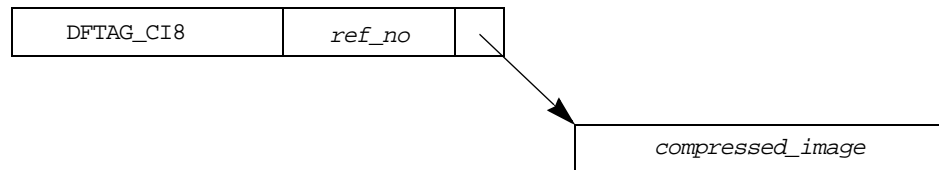

ref_no Reference number (16-bit integer)
compressed_image Series of run-length encoded bytes

The data for this tag is a row-wise representation of the elementary 8-bit image data. Each row is compressed using the following run-length encoding where *n* is the lower seven bits of the byte. The high bit indicates whether the following *n* bytes will be reproduced exactly (high bit = 0) or whether the following byte will be reproduced *n* times (high bit = 1). Since DFTAG_CI8 and DFTAG_RI8 are basically interchangeable, it is suggested that you not have a DFTAG_CI8 and a DFTAG_RI8 with the same reference number.

This tag has been superseded by DFTAG_RLE.

DFTAG_II8 IMCOMP image-8
 ? bytes
 204 (0x00CC)

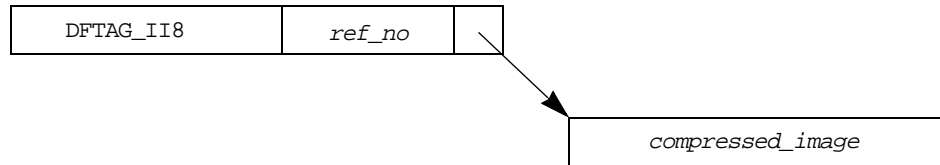

ref_no Reference number (16-bit integer)

compressed_image
 Compressed image data

The data for this tag is a 4:1 compressed 8-bit image, using the IMCOMP compression scheme. This tag has been superseded by DFTAG_IMC.

DFTAG_SDG Scientific data group
 $n*4$ bytes (where n is the number of data objects in the group)
 700 (0x02BC)

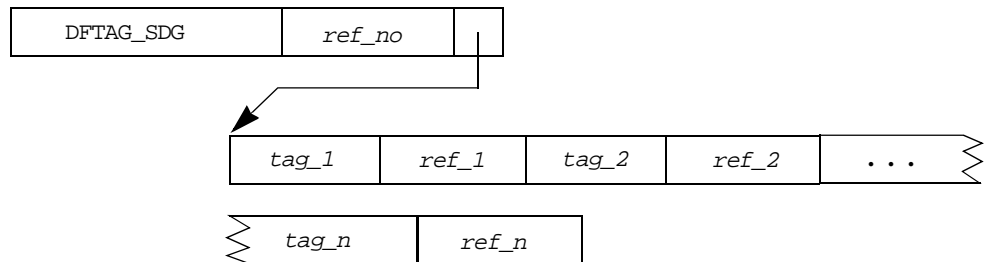

ref_no Reference number (16-bit integer)

tag_n Tag number of n^{th} member of the group (16-bit integer)

ref_n Reference number of n^{th} member of the group (16-bit integer)

The SDG data element contains a list of tag/refs that define a scientific data set. All of the members of the group provide information required to correctly interpret and display the data. Application programs that deal with SDGs should read all of the elements of an SDG and process those which it can use. Even if an application cannot process all of the objects, the objects that it can understand will be usable.

Table 9g lists the tags that may appear in an SDG.

TABLE 9g

Available SDG Tags

Tag	Description
DFTAG_SDD	Scientific data dimension record (rank and dimensions)
DFTAG_SD	Scientific data
DFTAG_SDS	Scales
DFTAG_SDL	Labels
DFTAG_SDU	Units
DFTAG_SDF	Formats
DFTAG_SDM	Maximum and minimum values
DFTAG_SDC	Coordinate system
DFTAG_SDT	Transposition (obsolete)
DFTAG_SDLNK	Link to new DFTAG_NDG

Example

DFTAG_SDD, DFTAG_SD, DFTAG_SDM

Assume that a dimension record, scientific data, and the maximum and minimum values of the data are required to read and interpret a particular data set. These data objects can be associated in an SDG so that an application can read the rank and dimensions from the dimension record and then read the data array. If the application needs the maximum and minimum values, it will read them as well.

This tag has been superseded by DFTAG_NDG.

See also: Chapter 5, "*Sets and Groups*"

DFTAG_SDT Scientific data transpose
 0 bytes
 709 (0x02C5)

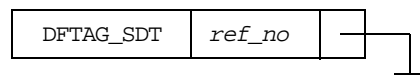

ref_no Reference number (16-bit integer)

The presence of this tag in a group indicates that the data pointed to by the corresponding DFTAG_SD is in column-major order, instead of the default row-major order. No data is associated with this tag.

This tag is no longer written by the HDF library. When it is encountered in an old file, it is interpreted as originally intended.

Extended Tags and Special Elements

10.1 Chapter Overview

This chapter provides detailed information regarding NCSA-supported HDF extended tags and the special elements they define. General information about tags and detailed specifications of basic tags are presented in Chapter 9, “*Tag Specifications*.”

10.2 Extended Tags and Alternate Physical Storage Methods

Prior to HDF Version 3.2, each data element had to be stored in one contiguous block in the basic HDF file. Version 3.2 introduced *extended tags*, a mechanism supporting alternate physical data element storage structures. All NCSA-supported tags with variable-sized data elements can take advantage of the extended tag features.

10.2.1 Extended Tag Implementation

Extended tags are automatically recognized by current versions of the HDF library and interpreted according to a description record. The description record, a complete data element, identifies the type of extended element and provides the relevant parameters for data retrieval.

Extended tags currently support four styles of alternate physical storage:

- *Linked block elements* are stored in several non-contiguous blocks within the basic HDF file.
- *External elements* are stored in a separate file, external to the basic HDF file.
- *Chunked elements* are stored in blocks within the basic HDF file to facilitate selective I/O.
- *Compressed elements* are stored in a configurable compressed mode within the basic HDF file to save storage space and to speed I/O and data transfer.

Every NCSA-supported tag is represented in HDF libraries and files by a tag number. NCSA-supported tags that take advantage of alternative physical storage features have an alternative tag number, called an *extended tag number*, that appears instead of the original tag number when an alternative physical storage method is in use.

When NCSA determines that an extended tag should be defined for a given tag, the extended tag number is determined by performing an arithmetic OR with the original tag number and the hexadecimal number 0x4000. Since all basic tags are numbered 0x0001 through 0x3FFF, this arithmetic OR effectively adds 0x4000, or a decimal value of 16384, to derive the extended tag value.

For example, the tag `DFTAG_RI` points to a data element containing a raster image. If the data element is stored contiguously in the same HDF file, the DD contains the tag number 302; if the

data element is stored either in linked blocks or in an external file, the DD contains the extended tag number 16686.

If a data object uses a regular tag number, its storage structure will be exactly as described in the "Section 9.3, "Tag Specifications." Figure 10a illustrates this general structure with the DD pointing directly to a single, contiguous data block.

FIGURE 10a

Regular Data Object

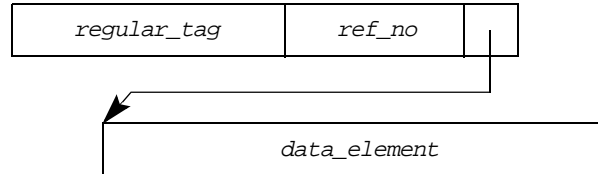

regular_tag Tag number

ref_no Reference number

data_element The data element

If a data object uses an extended tag, the storage structure will appear generally as illustrated in Figure 10b. The DD will point to an extended tag description record which in turn will point to the data.

FIGURE 10b

Data Object with Extended Tag

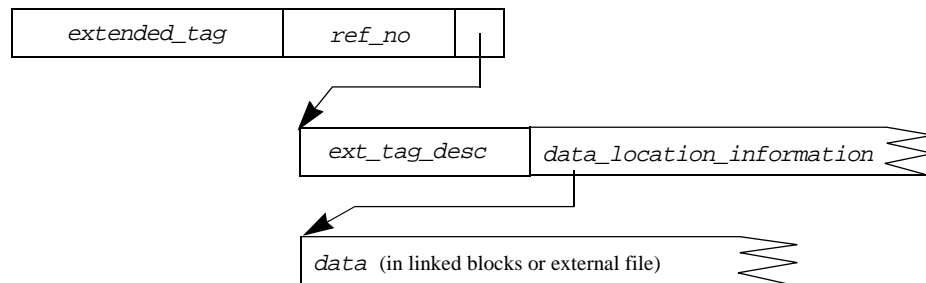

extended_tag Extended tag number

ref_no Reference number

ext_tag_desc A 32-bit constant defined in `Hdfi.h` that identifies the type of alternative storage involved. Current definitions include `EXT_LINKED` for linked block elements or `EXT_EXTERN` for external elements.

data_location_information

Information identifying and describing the linked blocks or external file

data The data, stored either in linked blocks or in an external file

Since the HDF tools were modified for HDF Version 3.2 to handle extended tags automatically, the only thing the user ever has to do is specify the use of either the linked blocks mechanism or an external file. Once that has been specified, the user can forget about extended tags entirely; the HDF library will manage everything correctly.

There is only one circumstance under which an HDF user will need to be concerned with the difference between regular tag numbers and extended tag numbers. If a user bypasses the regular HDF interface to examine a raw HDF file, that user will have to know the extended tag numbers, their significance, and the alternative storage structures.

10.3 Linked Block Elements

As mentioned above, data elements had to be stored as single contiguous blocks within the basic HDF file prior to HDF Version 3.2. This meant that if a data element grew larger than the allotted space, the file had to be erased from its current location and rewritten at the end of the file.

Linked blocks provide a convenient means of addressing this problem by linking new data blocks to a pre-existing data element. Linked block elements consist of a series of data blocks chained together in a linked list (similar to the DD list). The data blocks must be of uniform size, except for the first block, which is considered a special case.

The linked block data element is a description record beginning with the constant `EXT_LINKED`, which identifies the linked block storage method. The rest of the record describes the organization of the data element stored as linked blocks. Figure 10c illustrates a linked block description record.

FIGURE 10c

Linked Block Description Record

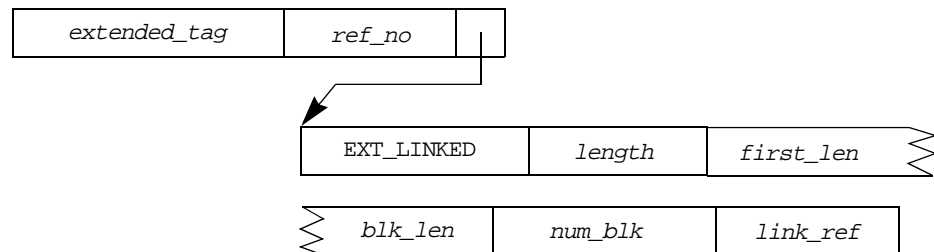

<i>extended_tag</i>	The extended tag counterpart of any NCSA standard tag (16-bit integer)
<i>ref_no</i>	Reference number (16-bit integer)
<code>EXT_LINKED</code>	Constant identifying this as a linked block description record (32-bit integer)
<i>length</i>	Length of entire element (32-bit integer)
<i>first_len</i>	Length of the first data block (32-bit integer)
<i>blk_len</i>	Length of successive data blocks (32-bit integer)
<i>num_blk</i>	Number of blocks per block table (32-bit integer)
<i>link_ref</i>	Reference number of first block table (16-bit integer)

The *link_ref* field of the description record gives the reference number of the first linked block table for the element. This table is identified by the tag/ref `DFTAG_LINKED/link_ref` and contains *num_blk* entries. There may be any number of linked block tables chained together to describe a linked block element. Figure 10d illustrates a linked block table.

FIGURE 10d

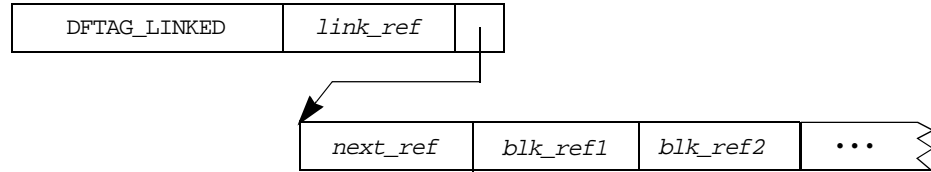
A Linked Block Table

- link_ref* Reference number for this table (16-bit integer)
- next_ref* Reference number for next table (16-bit integer)
- blk_ref_n* Reference number for data block (16-bit integer)

The *next_ref* field contains the reference number of the next linked block table. A value of zero (0) in this field indicates that there are no additional linked block tables associated with this element.

The *blk_ref_n* fields of each linked block table contain reference numbers for the individual data blocks that make up the data portion of the linked block element. These data blocks are identified by the tag/ref DFTAG_LINKED/*blk_ref_n* as illustrated in Figure 10e. Although it may seem ambiguous to use the same tag to refer to two different objects, this ambiguity is resolved by the context in which the tags appear.

FIGURE 10e

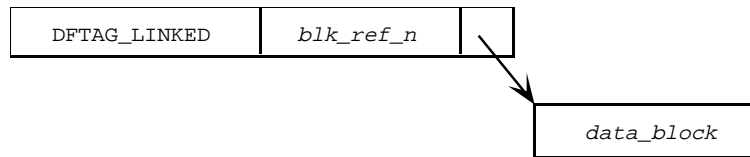
A Data Block

- blk_ref_n* Reference number for this data block (16-bit integer)
- data_block* Block of actual data (size specified by *first_len* or *blk_len* in the description record)

Linked block elements can be created using the function `HLcreate()`, which is discussed in Chapter 4, “*Low-level Interface*.”

10.4 External Elements

External elements allow the data portion of an HDF element to reside in a separate file. The potential of external data elements is largely unexplored in the HDF context, although other file formats (most notably the Common Data Format, CDF, from NASA) have used external data elements to great advantage.

Because there has been little discussion of external elements within the HDF user community, the structure of these elements is still not completely defined. Figure 10f shows a diagram of the suggested structure for an external element.

FIGURE 10f

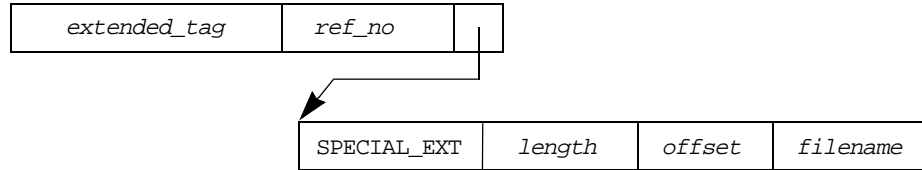
External Element Description Record

extended_tag The extended tag counterpart of any NCSA standard tag (16-bit integer)

ref_no Reference number (16-bit integer)

SPECIAL_EXT Constant identifying this as an external element description record (16-bit integer)

length Length in bytes of the data in the external file (32-bit integer)

offset Location of the data within the external file (32-bit integer)

filename Non-null terminated ASCII string naming the external file (any length)

An external element description record begins with the constant `SPECIAL_EXT`, which identifies the data object as having an externally stored data element. The rest of the description record consists of the specific information required to retrieve the data.

External elements can be created using the function `HXcreate()`, which is discussed in Chapter 4, “*Low-level Interface.*”

10.5 Chunked Data Storage

10.5.1 Chunked Element Description Record

The file format, or layout, of a chunked data element is specified in a *chunked element description record*. Figure 10g, “DD for a chunked element (12 bytes) pointing to a chunked element description record (>52 bytes),” provides a complete description, via illustration, of this record.

The fields that define a chunked element, as illustrated in Figure 10g, are as follows:

sp_tag_desc SPECIAL_CHUNKED (a 16-bit constant) identifies this as a chunked element description record.

sp_tag_head_len Length of this special element header only (4 bytes). Does not include length of header with additional *specialness* headers. Note: This is done to make this header layout similar to the multiple *specialness* layout.

version Version information (8-bit field).

flag Bit field to set additional specialness (32-bit field). Only the bottom 8 bits are currently used.

elem_tot_len Valid logical length of the entire element (4 bytes). The logical physical length is this value multiplied by *nt_size*. The actual physical length used for storage can be greater than the dataset size due to the presence of ghost areas in chunks. Partial chunks are not distinguished from regular chunks.

chunk_size Logical size of data chunks (4 bytes).

- nt_size Number type size, i.e the size of the data type (4 bytes).
- chk_tbl_tag Tag for the chunk table, i.e. the Vdata (2 bytes).
- chk_tbl_ref Reference number for the chunk table, i.e. the Vdata (2 bytes).
- sp_tag For future use. Special table for 'ghost' chunks (2 bytes).
- sp_ref For future use (2 bytes).
- ndims Number of dimensions of the chunked element.(4 bytes).
- file_val_num_bytes Number of bytes in fill value (4 bytes).
- fill value Fill value (variable bytes).

FIGURE 10g

DD for a chunked element (12 bytes) pointing to a chunked element description record (>52 bytes)

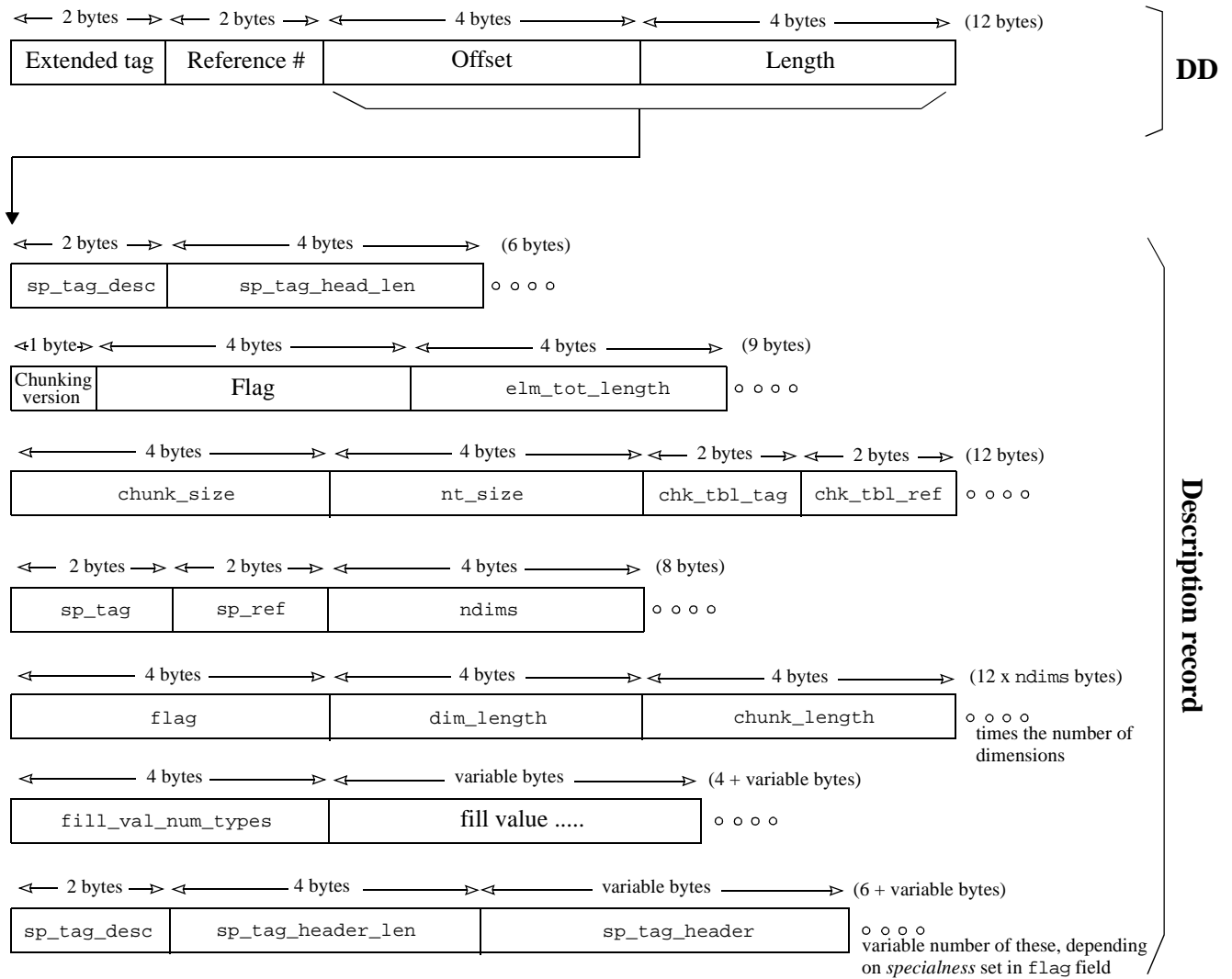

In addition to the above fields, each chunked element dimension requires a set of the following fields:

flag	(32-bit field) This field is divided as follows: High, 8 bits Medium High, 8 bits Medium Low, 8 bits Low, 8 bits •distrib_type (Low 8 bits, bits 0-7) Type of data distribution along this dimension 0x00 -> None 0x01 -> Block Currently only block distribution is supported but this is not currently checked or verified. •Other (Medium Low 8 bits, bits 7-15) 0x00 -> Regular dimension 0x01 -> UNLIMITED dimension
dim_length	Current length of this dimension (4 bytes).
chunk_length	Length of the chunk along this dimension (4 bytes).

Further, additional *specialnesses* may be used. Each additional *specialness* requires a set of the following fields:

sp_tag_desc	SPECIAL_XXX (16-bit constant) identifies this as an XXX element description record (16-bit field).
sp_tag_header_len	Length of special element header (4 bytes).
sp_tag_header	Special header (variable bytes).

10.5.2 Chunk Table

Information regarding a chunked data set is stored in the *chunk table*, described in Figure 10h on page 150.

The chunk table fields are defined as follows:

origin	Specifies the coordinates of the chunk in the overall chunk array. This is a variable-size field, depending on the number of dimensions of the chunked element.
chunk_tag	Currently DFTAG_CHUNK. Could be another chunked element to allow recursive chunked elements (DFTAG_CHUNKED). (16-bit field)
chunk_ref	Reference number of the chunk itself. (16-bit field)

FIGURE 10h

Chunk table

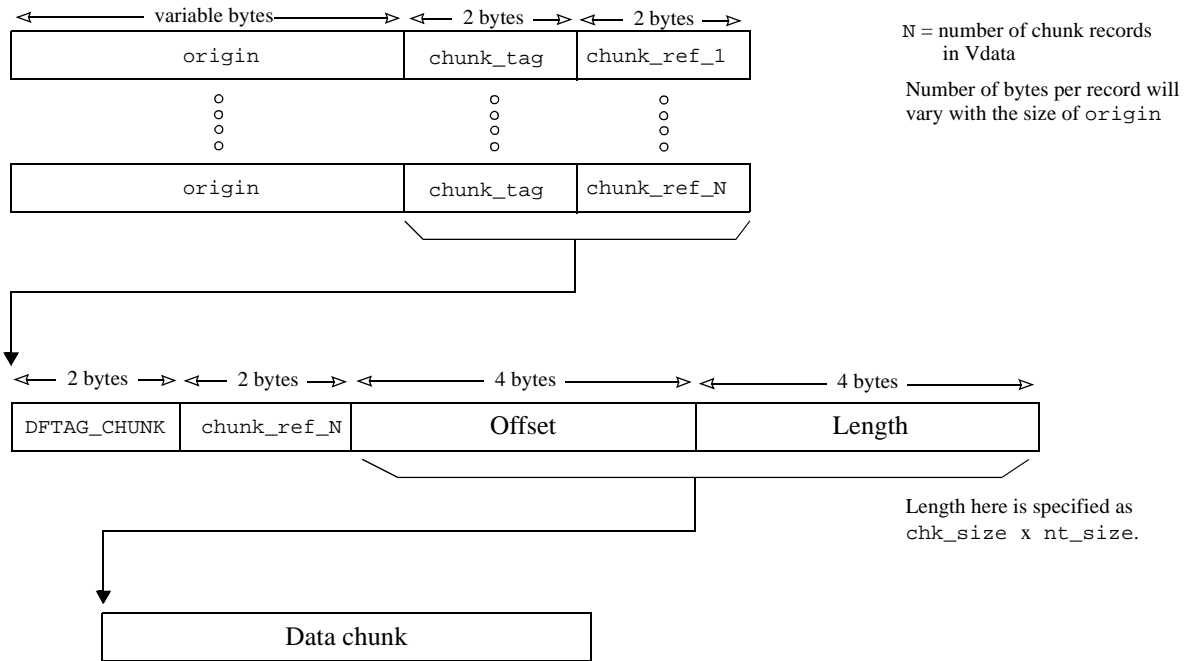

10.6 Data Compression

The HDF library supports the following compression formats for scientific data sets.

- Skipping-Huffman
- GNU ZIP deflation (Lempel/Ziv-77 dictionary coder)
- N-bit run-length encoding

The compression format of a data set is specified in an extended tag description known as a *compressed element description record*. Figure 10i, "Compression header extended tag description," describes the common elements of this record. Subsequent figures describe the remainder of the record, which varies for each type of compression.

10.6.1 Compression Header: The Common Elements of Compressed Element Description Records

The *compression header* comprises the common elements of all compressed element description records and is contained in the first ten fields of the record. As illustrated in Figure 10i, the compression header is made up of the following fields.

The first four fields of the compression header are common among all special element headers:

- Extended tag*
- Reference #* These two fields contain the tag/ref pair that identifies any HDF object.
- Offset* This is the offset, in bytes, to the location of the fifth field, or the *sp_tag_desc* field, of the compression header. This field always contains the value `SPECIAL_COMP` in a compressed element description record.
- Length* This field specifies the space requirement, in bytes, of the fifth through last fields of the compressed element description record.

The fifth through tenth fields are particular to the compression header:

- sp_tag_desc* `SPECIAL_COMP` (a 16-bit constant) identifies this as a compressed element description record.
- Version* Version information (16-bit field).
- Length of uncompressed data* Length, in bytes of the uncompressed data.
- Ref # of compressed data* As illustrated in Figure 10j, "Compressed element reference number," this field contains a pointer to a `DFTAG_COMPRESSED` structure which, in turn, provides the offset location and size, both in bytes, of the actual compressed data.
- Model type* Currently only streaming I/O.
- Compression type* A string identifying the type of compression in use.

The remainder of the compressed element description record is different for each type of compression. The following sections discuss each of those types of records in turn.

FIGURE 10i

Compression header extended tag description

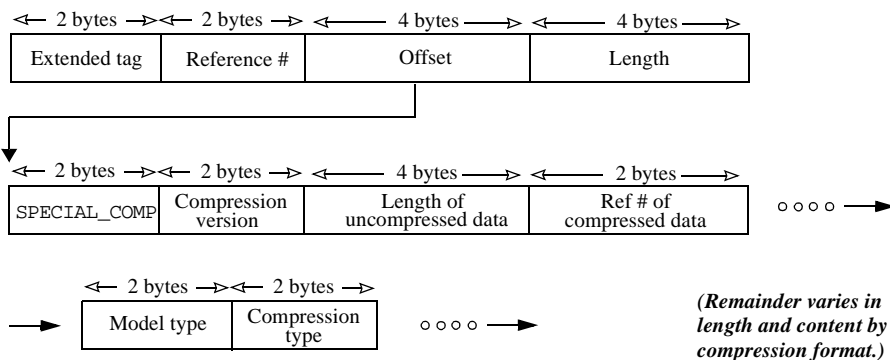
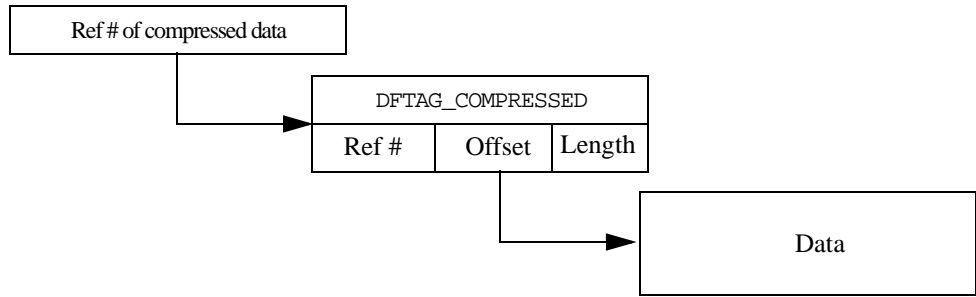

FIGURE 10j

Compressed element reference number



10.6.2 Compressed Element Description Record: NBIT Run-length Encoding

FIGURE 10k

Extended tag description for NBIT run-length encoding compression

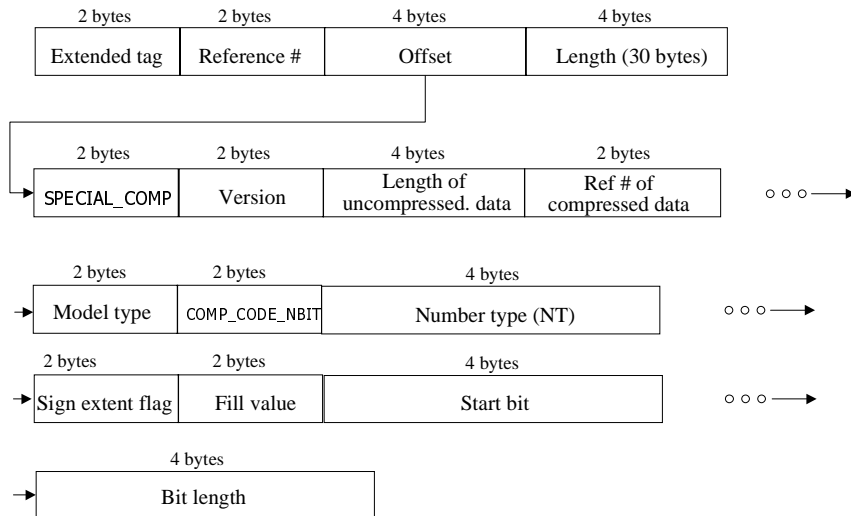

10.6.3 Compressed Element Description Record: Skipping-Huffman

FIGURE 10l

Extended tag description for Skipping-Huffman compression

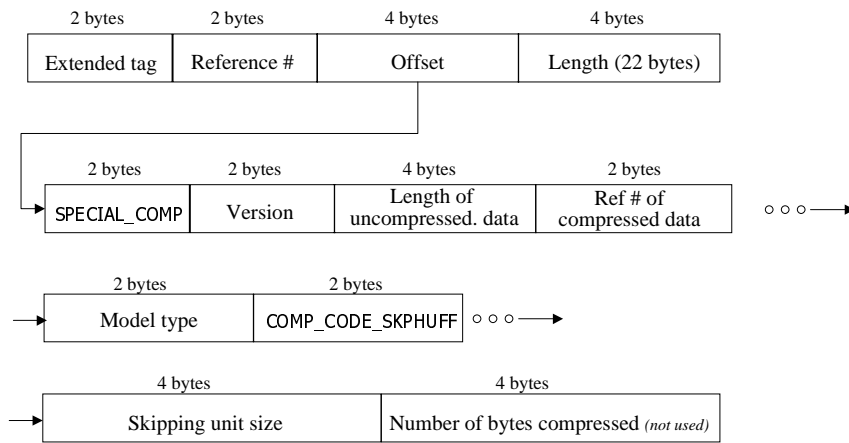

10.6.4 Compressed Element Description Record: GNU ZIP (Deflate)

FIGURE 10m

Extended tag description for GNU ZIP (deflate) compression

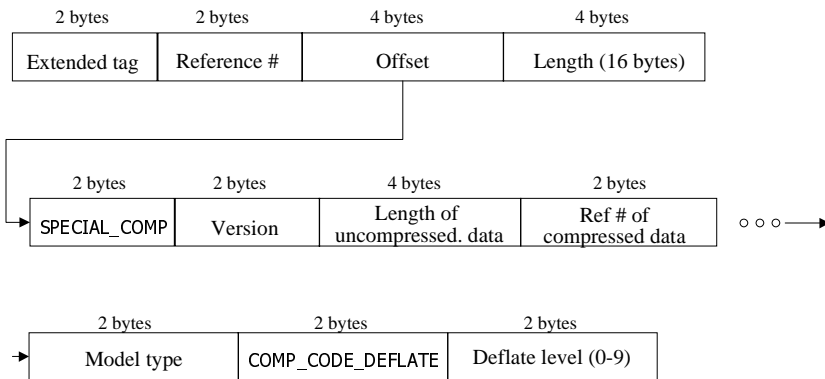

Portability Issues

11.1 Chapter Overview

The NCSA implementation of HDF is accessible to both C and FORTRAN programs and is implemented on many different machines and several operating systems. There are important differences between C and FORTRAN, and among implementations of each language, especially FORTRAN. There are also important differences among the machines and operating systems that HDF supports.

If HDF is to be a portable tool, these differences must be constructively addressed. This chapter describes many of these differences, discusses the problems and issues associated with them, and presents the methods employed in the HDF implementation to reduce their impact.

11.2 The HDF Environment

The list of machines and operating systems on which HDF is implemented is steadily growing. For reasons that this chapter will make clear, the number of NCSA-supported HDF platforms is growing slowly. Every time a platform is added, additional code must be written to address concerns of memory management, operating system and file system differences, number representations, and differences in FORTRAN and C implementations on that system.

11.2.1 Supported Platforms

As of this writing, NCSA supports the platforms listed in Table 11a.

TABLE 11a

NCSA-supported HDF Platforms

Hardware Platform	Operating System
Convex	Concentrix
Cray X-MP, Y-MP, Cray 2	UNICOS
DEC Alpha	Ultrix
DECStation	Ultrix
HP 9000	HPUX
IBM PC	MS DOS, Windows 3.1
IBM RS/6000	AIX
IBM RT	UNIX
Macintosh	MPW Shell
NeXT	NeXTStep
Silicon Graphics	UNIX

Hardware Platform	Operating System
Sun Sparc	UNIX
Vax	VMS

HDF has also been ported to several platforms that NCSA does not currently support. These include Alliant, Apollo (Domain), HP 3000, Stellar, Amiga, Symbolics, Fujitsu, and IBM 3090 (MVS).

11.2.2 Language Standards

Unfortunately, not all compilers are the same. FORTRAN compilers often differ in the ways they pass parameters, in the identifier naming conventions they employ, and in the number types that they support. Similarly, though generally not as drastically, C compilers differ in the number types that they support and in their adherence to the ANSI C standard.

To minimize the difficulties caused by these differences, the HDF source code is written primarily in the following dialects:

- FORTRAN 77
- ANSI C
- The original C defined by Kernighan and Ritchie¹, hereafter referred to as old C

Almost all platforms have C and FORTRAN compilers that adhere to at least one of these standards.

When time and resources permit, NCSA attempts to support features or variations in other dialects of C and FORTRAN, particularly on platforms that are important to NCSA users. Much of the remainder of this chapter addresses these efforts.

11.2.3 Guidelines

One cannot over stress the importance of following the guidelines outlined in this chapter. It may take longer to write code and it may be difficult to adapt your coding style, but the long-term benefits, in terms of portability and maintenance costs, will be well worth the effort.

11.3 Organization of Source Files

Three types of files appear in the HDF source code directory:

- Header files
- Source code files
- A makefile

Header files and source code files are organized by application area. All of the functions that apply to a particular application area are stored in three source files, and all the definitions and declarations that apply to that application are stored in a corresponding header file. The makefile describes the dependencies among the source and header files and provides the commands required to compile the corresponding libraries and utilities.

1. The version of C described in the first edition of *The C Programming Language*, by Brian Kernighan and Dennis Ritchie, published by Prentice-Hall.

11.3.1 Header Files

Certain application modules require header files. The header file `dfan.h`, for example, contains definitions and declarations that are unique to the annotation interface.

There are also several general header files that are used in compiling the libraries for all application areas:

`hdf.h` and `hdfi.h`¹

`hdf.h` contains declarations and definitions for the common data structures used throughout HDF, definitions of the HDF tags, definitions of error numbers, and definitions and declarations specific to the low level interface. Since `hdf.h` depends on `hdfi.h`, it includes `hdfi.h` via `#include`.

`hdfi.h` contains information specific to the various NCSA-supported HDF computing environments, environmental parameters that need to be set to particular values when compiling the HDF libraries, and machine dependent definitions of such things as number types and macros for reading and writing numbers.

When porting HDF to a new system, only `hdfi.h` and the makefile should need to be modified, though there may be exceptions.

It is normally a good idea to include `hdf.h` (and therefore indirectly `hdfi.h`) in user programs, though users usually need not be aware of its contents.

`hproto.h` This file contains ANSI C prototypes for all HDF C routines. It must be included in ANSI C programs that call HDF routines.

`constants.i` This file is for use in FORTRAN programs. It contains important constants, such as tag values, that are defined in `hdf.h`. Systems with FORTRAN preprocessors might be able to include this file via `#include` statements or their equivalent.

`dffunc.i` This file is for use in FORTRAN programs. It contains declarations of all HDF FORTRAN-callable functions. Systems with FORTRAN preprocessors might be able to include this file via `#include` statements or their equivalent.

11.3.2 Source Code Files

All HDF operations are performed by routines written in C. Hence, even FORTRAN calls to HDF result in calls to the corresponding C routines. Because of the problems described below the relationships between the C routines and the corresponding FORTRAN routines can be confusing. This section discusses the C and FORTRAN source file organization. It is followed by discussions of problems users will face in the FORTRAN-C interface.

HDF interfaces typically have three or four associated files. For example, the scientific data set (SDS) interface is associated with the following files: `dfsd.h`, `dfsd.c`, `dfsd.f.c`, and `dfsdff.f`.

These files fill the following roles:

1. Prior to Version 3.2 of HDF, these files were called `df.h` and `dfi.h`. At the time of HDF Version 3.2, the low level interfaces, the general purpose layer of HDF, was completely rewritten and all routine names were changed from `df*` to `hdf*`.

Header files

The *.h files are header files.

Normal C routines

These routines do the actual HDF work. The others are used to transfer control and data from a FORTRAN environment to a C environment.

These routines are in the *.c files, as in `dfsdf.c`. Every call to HDF, whether from C or FORTRAN, ultimately results in a call to one of these routines.

C routines that are directly callable from FORTRAN

These routines provide recognizable function names to the linker. They may also perform operations on data they receive from the FORTRAN routines that call them, such as transferring a FORTRAN string to a local C data area. Examples are provided below.

These routines are in the *.f.c files, such as `dfsdf.f.c`. The `f` means that the routines can be called from FORTRAN; the `.c` means that they are C source code.

FORTRAN routines that perform some operation on the parameters that C would be unable to perform, before and/or after calling the corresponding C routine

These routines are required, for example, when one of the parameters is a string. The corresponding C routine has no way of knowing the length of the string unless it is explicitly given the length by the FORTRAN routine.

These routines are in the *.ff.f files, such as `dfsdf.ff.f`. The `ff` means that the routines perform some FORTRAN operation that C cannot perform and that they are to be called from FORTRAN; the `.f` means that they are FORTRAN source code.

The roles of these different types of source file types will become clearer as we look at some of the problems that arise in interfacing C and many different implementations of FORTRAN.

11.3.3 File Naming Conventions

The naming conventions for HDF library source code files are complicated by several factors. Because HDF must accommodate a wide variety of platforms, all files that will compile to object modules must have names that are unique in the first 8 characters, ignoring case. The difficulties involved in maintaining a FORTRAN-callable interface to a library that is primarily written in C further complicate the naming of source code files.

11.4 Passing Strings between FORTRAN and C

One of the most important differences between FORTRAN and C compilers is in the way strings are represented. Different compilers use different data structures for strings, and supply string length information in different ways.

11.4.1 Passing Strings from FORTRAN to C

When strings are passed between FORTRAN and C routines, they may need to be converted from one representation to the other. C compilers store strings in an array of type `char`, terminated by a null byte (`\0`). The name of a string variable is equivalent to a pointer to the first character in the string. FORTRAN compilers are not consistent in the ways that they store strings.

Two pieces of information must be acquired before FORTRAN can pass a string to C:

- The string's length
- The string's address

The string's length is determined by invoking the standard FORTRAN function `len()`, which returns the length of a string. Since C expects a null byte at the end of a string, care must be taken that this null byte does not overwrite useful information in the FORTRAN string.

Determining the string's address is more difficult because of the different ways that different FORTRAN implementations store strings. The macro `_fcdtoCP` (FORTRAN character descriptor to C pointer) is used to acquire this information. `_fcdtoCP` is one of the elements that must be customized for each platform. The following paragraphs discuss several existing customized implementations:

- UNICOS FORTRAN stores strings in a structure called `_fcd` (FORTRAN character descriptor). `_fcdtoCP` is a built-in UNICOS function that returns the string's address. (Since UNICOS provides this function, HDF omits the corresponding macro definition on UNICOS systems.)
- VMS FORTRAN uses a string descriptor structure that provides the string's address and length. When compiled under VMS, `_fcdtoCP` extracts the string's address from that structure.
- Most other FORTRAN compilers supported by HDF store strings just as C does, in character arrays with the array name identifying the array's address. In such situations, nothing special needs to be done to pass a string from FORTRAN to C, except to add a NULL byte.

An HDF FORTRAN call that involves passing a string results in the following sequence of actions:

- 1 A FORTRAN filter routine determines the length and address in memory of the string. Since this filter is a FORTRAN routine, it can be found in the appropriate `*ff.f` file.
- 2 The FORTRAN filter then calls a C routine, to which it passes all parameters from the initial call the string's length.
- 3 The C routine converts the FORTRAN string to a C string by copying it to a C array of type `char` and appending a null byte. Since this C routine serves as a link between a FORTRAN filter and the corresponding C interface call, it can be found in the appropriate `*f.c` file.
- 4 This C routine then calls the HDF C routine that performs the actual work.

This process is illustrated in Figure 11a, "Sequence of Events when a FORTRAN Call Includes a String as a Parameter."

FIGURE 11a

Sequence of Events when a FORTRAN Call Includes a String as a Parameter

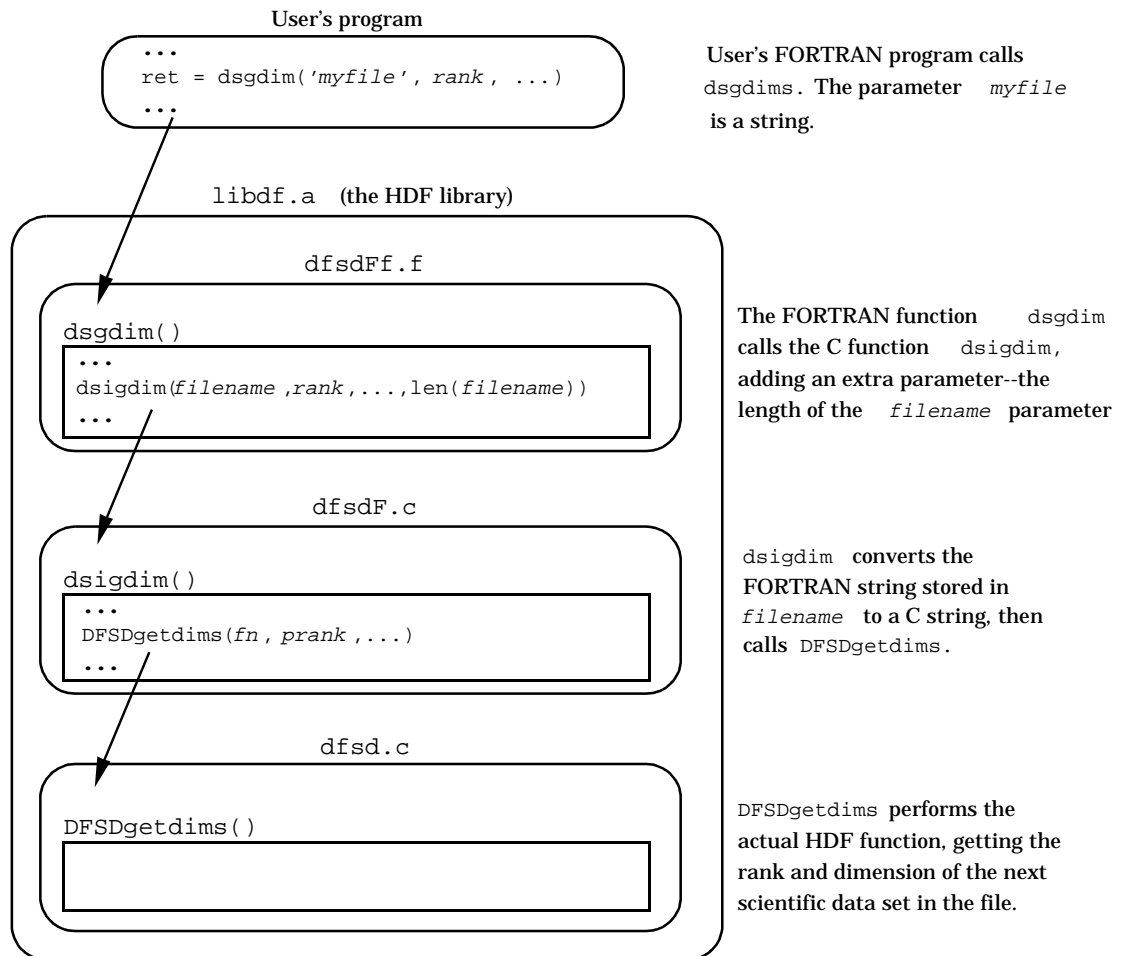

11.4.2 Passing Strings from C to FORTRAN

When strings are passed from C to FORTRAN, the reverse procedure is followed. First, a string pointer is allocated within the FORTRAN routine's data area. (It is assumed that the space pointed to has already been allocated, and is sufficiently large to hold the string.) The string is then copied from the C data area to the FORTRAN data area. Finally, the FORTRAN string's data area is padded with blanks, if necessary.

11.5 Function Return Values between FORTRAN and C

When a FORTRAN routine calls a C function, it always expects a return value from that function. Unfortunately, C functions do not always return arguments in a FORTRAN-compatible format.

To solve this problem, some FORTRAN compilers offer the option of controlling the form of the return value from a function. For example, Language Systems FORTRAN for the Macintosh

requires that all C function declarations be prepended by the word `pascal` so that the return value can be recognized by a FORTRAN routine that calls it, as in:

```
pascal int dsgrang(void *pmax, void *pmin)
```

Since C always expects return values to be passed by value rather than, say, by reference, it is important to coerce FORTRAN functions to do the same. This is accomplished by defining a macro `FRETVAL` that is prepended to the declaration of every FORTRAN-callable C function. For example:

```
FRETVAL(int)
dsgrang(void *pmax, void *pmin)
```

If Language Systems FORTRAN is to be used, `FRETVAL` is defined in `hdfi.h` as follows:

```
#if defined(MAC)          /* with LS FORTRAN */
#  define FRETVAL(x)    pascal x
#endif
```

11.6 Differences in Routine Names

HDF generally employs standard C conventions in naming routines. But many FORTRAN compilers impose varying restrictions on the length, character set, and form of identifiers, some of which are considerable more restrictive than the C conventions. Therefore, an extra effort must be made to accommodate those FORTRAN compilers.

To address this issue, HDF defines a set of preprocessor flags in `hdfi.h`. Then conditional compilation, with `#ifdef` statements in the source code, produces routine names that the target system's FORTRAN will understand.

11.6.1 Case Sensitivity

C compilers are *case sensitive*; uppercase and lowercase letters are recognized as different characters. Many FORTRAN compilers are not case sensitive; they allow users to use uppercase and lowercase letters while naming routines in the source code, but the names are converted to all uppercase or all lowercase in the object module symbol tables. Routine name recognition problems are common when routines compiled by a case sensitive compiler are to be linked with routines compiled by a non-case sensitive compiler.

For example, the UNICOS FORTRAN compiler allows you to name routines without regard to case, but produces object module symbol tables with the routine names in all uppercase. UNICOS C, on the other hand, performs no such conversion.

Consider the HDF routine `Hopen`. `Hopen` is written in C, so the HDF library symbol table contains the name `Hopen`. Suppose you make the following call in your UNICOS FORTRAN program:

```
file_id = Hopen('myfile', ...)
```

The FORTRAN compiler will create an object module symbol table with the routine name `HOPEN`. When you link it to the HDF library, it will find `Hopen` but not `HOPEN`, and will generate an unsatisfied external reference error.

HDF supports the following non-case sensitive compilers:

- VMS FORTRAN
- UNICOS FORTRAN
- Language Systems FORTRAN.

All of these compilers convert identifiers to all uppercase when building an object module symbol table. In the following discussion, they are referred to as *all-uppercase compilers*.

The HDF Solution

HDF addresses the all-uppercase compiler problem in the platform-specific section of `hdfi.h` where the `DF_CAPFNAMES` flag is defined. With conditional compilation, HDF generates all-uppercase routine names and symbol table entries.

Once again, consider UNICOS. The UNICOS section of `hdfi.h` contains the following line:

```
#define DF_CAPFNAMES
```

The `*f.c` files contain corresponding conditional sections that produce all-uppercase routine names. For example, the function name `Fun` can be redefined as `FUN`:

```
#ifdef DF_CAPFNAMES
    define Fun FUN
#endif /* DF_CAPFNAMES */
```

11.6.2 Appended Underscores

Differing compiler conventions create a similar problem in their use of the underscore (`_`) character. Many compilers, including most C compilers, prepend an underscore to all external symbols in the object module symbol table. The linker then looks for external symbols in other symbol tables with the prefixed underscore.

Many FORTRAN compilers also *append* an underscore to identify external symbols. Since C compilers do not generally do this, external references in FORTRAN-generated object modules will not recognize externals with the same names in C-generated modules.

For example, the FORTRAN compiler on the CONVEX system places an underscore both at the beginning and at the end of routine names, while the C compiler places an underscore only at the beginning.

Since `FUN` is a C function, it appears under the name `_FUN` in the object module containing it. Now suppose you make the following call in a FORTRAN program:

```
x = FUN(y)
```

The FORTRAN compiler will create an object module symbol table with the routine name `_FUN_`. When you link it to the C module, the linker will be unable to link `_FUN` and `_FUN_` and will generate an unsatisfied external reference error.

The HDF Solution

Like the all-uppercase compiler problem, this issue is resolved in the platform-specific sections of `hdfi.h` and with conditional sections of code that append an underscore to C routine names on platforms where the FORTRAN compiler expects it.

This is implemented as follows: The `FNAME_POST_UNDERSCORE` flag is defined in the platform-specific section of `hdfi.h` for every platform whose FORTRAN compiler requires appended underscores. Similarly, the `FNAME_PRE_UNDERSCORE` flag is defined on platforms where the FORTRAN compiler expects prepended underscores. The macro `FNAME` is then defined to append and/or prepend underscores as required.

The `FNAME` macro is then applied to each routine in the module in which it is actually defined (including in `hproto.h`), adding the appropriate underscores.

Consider the above example in which `Fun` was renamed `FUN`. The actual definition appears as follows:

```
#ifdef DF_CAPFNAMES
    define Fun FNAME(FUN)
#endif /* DF_CAPFNAMES */
```

11.6.3 Short Names vs. Long Names

In the C implementations supported by HDF, identifiers may be any length with at least the first 31 characters being significant. FORTRAN compilers differ in the maximum lengths of identifiers that they allow, but all of those supported by HDF allow identifiers to be at least seven characters long.

To deal with the discrepancies between identifier lengths allowed by C and those allowed by the various FORTRAN compilers, a set of equivalent short names has been created for use when programming in FORTRAN. For every HDF routine with a name more than seven characters long, there is an identical routine whose name is seven or fewer characters long.

For example, the routines `DFSDgetdims` (in `dfsd.c`) and `dsqdims` (in `dfsdff.f`) are functionally identical.

11.7 Differences Between ANSI C and Old C

The current HDF release supports both ANSI C and old C compilers. ANSI C is preferred because it has many features that help ensure portability; unfortunately, many important platforms do not support full ANSI C. The HDF code determines whether ANSI C is available from the flag `__STDC__`. If ANSI C is available on a platform, then `__STDC__` is defined by the compiler.¹

The most noticeable difference between ANSI C and old C is in the way functions are declared. For example, in ANSI C the function `DFSDsetdims()` is declared with a single line:

```
int DFSDsetdims(intn rank, int32 dimsizes[])
```

In old C the same function is declared as follows:

```
int DFSDsetdims(rank, dimsizes)
intn rank;
int32 dimsizes[];
```

HDF accommodates these differences by defining the flag `PROTOTYPE` in `hdfi.h`. `PROTOTYPE` is used for every function declaration in a manner similar to the following example:

```
#ifdef PROTOTYPE
int DFSDsetdims(intn rank, int32 dimsizes[])
#else
int DFSDsetdims(rank, dimsizes)
intn rank;
int32 dimsizes[];
#endif /* PROTOTYPE */
```

Note that prototypes are supported by some C compilers that are not otherwise ANSI-conformant. In such situations, `PROTOTYPE` is defined even though `__STDC__` is not.

1. `__STD__` is generally defined by ANSI-conforming C compilers. Some C compilers are not entirely ANSI-conforming, yet they conform well enough that the HDF implementation can treat them as if they were. In such cases, it is permissible to define `__STDC__` by adding the option `-D__STDC__` to the `cc` line in the makefile.

Another difference between old C and ANSI C is that ANSI C supports function prototypes with arguments. (Old C also supports function prototypes, but without the argument list.) This feature helps in detecting errors in the number and types of arguments. This difference is handled by means of a macro `PROTO`, which is defined as follows:

```
#ifndef PROTOTYPE
#define PROTO(x) x
#else
#define PROTO(x) ()
#endif
```

This macro is applied as in the following example:

```
extern int32 Hopen
PROTO((char *path, intn access, int16 ndds));
```

When `PROTOTYPE` is defined, `PROTO` causes the argument list to stay as it is. When `PROTOTYPE` is not defined, `PROTO` causes the argument list to disappear.

11.8 Type Differences

Platforms and compilers also differ in the sizes of numbers that they assign to different data types, in their representations of different number types, and in the way they organize aggregates of numbers (especially structures).

11.8.1 Size differences

The same number type can be different sizes on different platforms. The type `int`, for example, is 16 bits to many IBM PC compilers, 48 bits to some supercomputer compilers, and 32 bits on most others. This can cause problems that are difficult to diagnose in code like the HDF code, which depends in many places on numbers being the right size.

HDF handles this problem by fully defining all variable types and function data types via `typedef`, including the number of bits occupied. All parameters, members of structures, and static, automatic, and external variables are so defined .

The HDF data types include the following (types with the prefix `u` are unsigned).

```
int8
uint8
int16
uint16
int32
uint32
float32
float64
intn
uintn
```

For each machine, typedefs are declared that map all of the data types used into the best available types. For example, `int32` is defined as follows for Sun's C compiler:

```
typedef long int int32;
```

Unfortunately, the HDF data types do not always map exactly to one of the native data types. For example, the Cray UNICOS C compiler does not support a 16-bit data type. In such instances, HDF uses the best available match and care is taken to minimize potential problems.

The data types `intn` and `uintn` are for situations where it can be determined that number type size is unimportant and that a 16-bit integer is large enough to hold any value the number can have. In such cases, the native integer type (or unsigned integer type) of the host machine is used. Experience indicates that substantial performance gains can be achieved by using `intn` or `uintn` in certain circumstances.

11.8.2 Number Representation

One of the keys to producing a portable file format is to ensure that numbers that are represented differently on different machines are converted correctly when moved from machine to machine. HDF provides conversion routines to convert between native representations and a standard representation that is actually used in the HDF file. This ensures that HDF data will always be interpreted correctly, regardless of the platform on which it is read or written. Details of this process will be included in a later edition of this manual.

11.8.3 Byte-order and Structure Representations

Even when the basic bit-representation of constants or aggregates like structures is the same across platforms, the ways that the bits are packed into a word and the order in which the bits are laid out can differ. For example, DEC and Intel-based machines generally order bytes differently from most others. And the C compiler on a Cray, with a 64-bit word, packs structures differently from those on 32-bit word machines.

Differences in byte order among machines are handled in either of two ways. When the data to be written (or read) includes non-integer data and/or a large array of any type of data, conversion routines mentioned in the previous section, "Number Representation," are invoked. When an individual integer is to be written (or read), an `ENCODE` or `DECODE` macro is used.

The following `ENCODE` and `DECODE` macros are available for 16-bit and 32-bit integers:

```
INT16ENCODE
UINT16ENCODE
INT32ENCODE
UINT32ENCODE
INT16DECODE
UINT16DECODE
INT32DECODE
UINT32DECODE
```

The `ENCODE` macros write integers to an HDF file in a standard format regardless of the word-size and byte order of the host machine.

Likewise, the `DECODE` macros read integers from a standard format in an HDF file and provide the integers in the required byte order and word size to the host machine.

Since the `ENCODE` and `DECODE` macros deal with both byte order and word size, they are also used in reading and writing record-like structures. For example, an HDF data descriptor consists of two 16-bit fields followed by two 32-bit fields, as implied by the following C declaration:

```
struct {
    uint16 tag;
    uint16 ref;
    uint32 offset;
```

```
    uint32 length;  
}
```

Even though this structure might occupy 12 bytes on one platform or 32 bytes on another (e.g., a Cray), it must occupy exactly 12 bytes in an HDF file. Furthermore, some machines represent the numbers internally in different byte orders than others, but the byte order must always be big-endian in an HDF file. The `ENCODE` and `DECODE` macros ensure that these values are always represented correctly in HDF files and as presented to any host machine.

11.9 Access to Library Functions

Despite standardization efforts, function libraries often differ in significant ways. At least three types of functions require special treatment in the HDF implementation:

File I/O

Some platforms use 16-bit values for the element size and the number of elements to write or read, while others use 32-bit values. This must be considered when working with either stream or system level I/O functions (i.e., the functions associated with the `fopen()` and `open()` calls).

Memory allocation and release

First, 16-bit machines use a 16-bit value to indicate the number of bytes to allocate or release at one time. Second, certain operating systems (notably MS Windows and MAC/OS) don't have `malloc()` and `free()` calls. These operating systems use handles for allocating memory and require different function calls.

Memory and string manipulation

These functions (e.g., `memcpy()`, `memcmp()`, `strcpy()`, and `strlen()`) require slightly different function names under different memory models in MS DOS and under MS Windows than on most other systems.

HDF accommodates these special situations by defining appropriate macros in the machine-specific sections of `hdfi.h`.

Tags and Extended Tag Labels

A.10 Overview

The tables in this appendix lists all of the NCSA-supported HDF tags and the labels used to identify extended tags.z

A.11 Tags

Table Aa lists all the NCSA-supported HDF tags with the following information:

Tag	The tag itself
Tag number	The regular tag number in decimal (top) and hexadecimal (bottom)
Extended tag number	The extended tag number used with linked blocks and external data elements in decimal and (hexadecimal)
Full name	The tag name, a descriptive English phrase
Section	The section of Chapter 9, “ <i>Tag Specifications</i> ,” in which the tag is discussed

The tags are listed in alphabetical order. Not all tags have extended tag numbers.

TABLE Aa

NCSA-supported HDF Tags

Tag	Number	Extended Number	Full Name	Section
DFTAG_AR	312 0x0138		Aspect ratio	Raster Image Tags
DFTAG_CAL	731 0x02DB		Calibration information	Scientific Data Set Tags
DFTAG_CCN	310 0x0136		Color correction	Raster Image Tags
DFTAG_CFM	311 0x0137		Color format	Raster Image Tags
DFTAG_CI8	203 0x00CB		Compressed image-8	Obsolete Tags
DFTAG_DIA	105 0x0069		Data identifier annotation	Annotation Tags

Tag	Number	Extended Number	Full Name	Section
DFTAG_DIL	104 0x0068		Data identifier label	Annotation Tags
DFTAG_DRAW	400 0x0190		Draw	Composite Image Tags
DFTAG_FD	101 0x0065		File description	Annotation Tags
DFTAG_FID	100 0x0064		File identifier	Annotation Tags
DFTAG_FV	732 0x02DC		Fill value	Scientific Data Set Tags
DFTAG_GREYJPEG	14 0x000E		8-bit JPEG compression information	Compression Tags
DFTAG_ID	300 0x012C		Image dimension	Raster Image Tags
DFTAG_ID8	200 0x00C8		Image dimension-8	Obsolete Tags
DFTAG_II8	204 0x00CC		IMCOMP image-8	Obsolete Tags
DFTAG_IMC	12 0x000C		IMCOMP compressed data	Compression Tags
DFTAG_IP8	201 0x00C9		Image palette-8	Obsolete Tags
DFTAG_JPEG	13 0x000D		24-bit JPEG compression information	Compression Tags
DFTAG_LD	307 0x0133		LUT dimension	Raster Image Tags
DFTAG_LUT	301 0x012D		Lookup table	Raster Image Tags
DFTAG_MA	309 0x0135		Matte channel	Raster Image Tags
DFTAG_MD	308 0x0134		Matte channel dimension	Raster Image Tags
DFTAG_MT	107 0x006B		Machine type	Utility Tags
DFTAG_NDG	720 0x02D0		Numeric data group	Scientific Data Set Tags
DFTAG_NT	106 0x006A		Number type	Utility Tags
DFTAG_NULL	1 0x0001		No data	Utility Tags
DFTAG_RI	302 0x012E	16686 0x412E	Raster image	Raster Image Tags
DFTAG_RI8	202 0x00CA		Raster image-8	Obsolete Tags

Tag	Number	Extended Number	Full Name	Section
DFTAG_RIG	306 0x0132		Raster image group	Raster Image Tags
DFTAG_RLE	11 0x000B		Run length encoded data	Compression Tags
DFTAG_SD	702 0x02BE	17086 0x42BE	Scientific data	Scientific Data Set Tags
DFTAG_SDC	708 0x02C4		Scientific data coordinates	Scientific Data Set Tags
DFTAG_SDD	701 0x02BD		Scientific data dimension record	Scientific Data Set Tags
DFTAG_SDF	706 0x02C2		Scientific data format	Scientific Data Set Tags
DFTAG_SDG	700 0x02BC		Scientific data group	Obsolete Tags
DFTAG_SDL	704 0x02C0		Scientific data labels	Scientific Data Set Tags
DFTAG_SDLNK	710 0x02C6		Scientific data set link	Scientific Data Set Tags
DFTAG_SDM	707 0x02C3		Scientific data max/min	Scientific Data Set Tags
DFTAG_SDS	703 0x02BF		Scientific data scales	Scientific Data Set Tags
DFTAG_SDT	709 0x02C5		Scientific data transpose	Obsolete Tags
DFTAG_SDU	705 0x02C1		Scientific data units	Scientific Data Set Tags
DFTAG_T105	603 0x25B		Tektronix 4105	Vector Image Tags
DFTAG_T14	602 0x25A		Tektronix 4014	Vector Image Tags
DFTAG_TD	103 0x0067		Tag description	Annotation Tags
DFTAG_TID	102 0x0066		Tag identifier	Annotation Tags
DFTAG_VERSION	30 0x001E		Library version number	Utility Tags
DFTAG_VG	1965 0x07AD		Vgroup	Vset Tags
DFTAG_VH	1962 0x07AA		Vdata description	Vset Tags
DFTAG_VS	1963 0x07AB	18347 0x47AB	Vdata	Vset Tags
DFTAG_XYP	500 0x01F4		X-Y position	Composite Image Tags

A.12 Extended Tag Labels

Table Ab lists labels used to identify HDF extended tags. The table includes the following information:

Extended tag label The label, which appears as the first element of the extended tag description record

Physical storage method The alternative storage method indicated by the label

TABLE Ab

Extended Tag Labels

Extended Tag Label	Physical Storage Method
EXT_EXTERN	External file element
EXT_LINKED	Linked block element
SPECIAL_COMP	Compressed element
SPECIAL_CHUNKED	Chunked element

Library Calling Trees

B.13 Overview

This appendix illustrates the calling trees employed in the HDF library.

B.14 Library Calling Trees: SD API

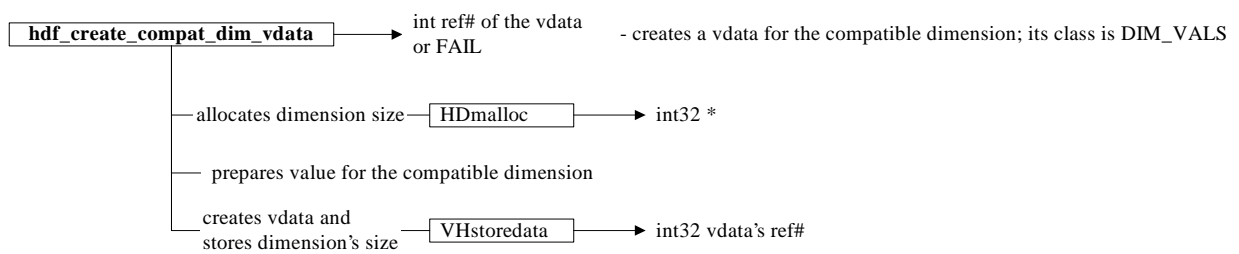

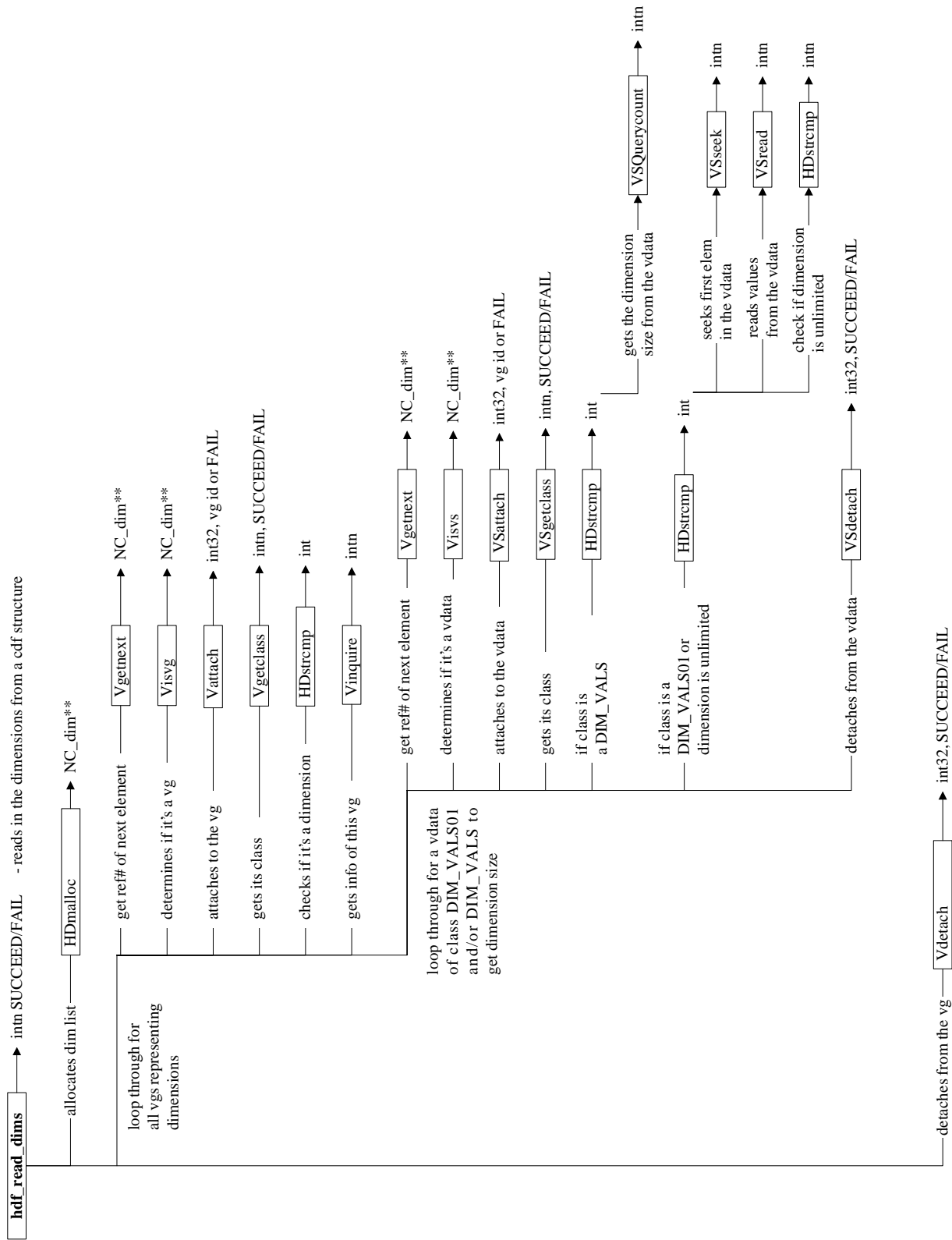

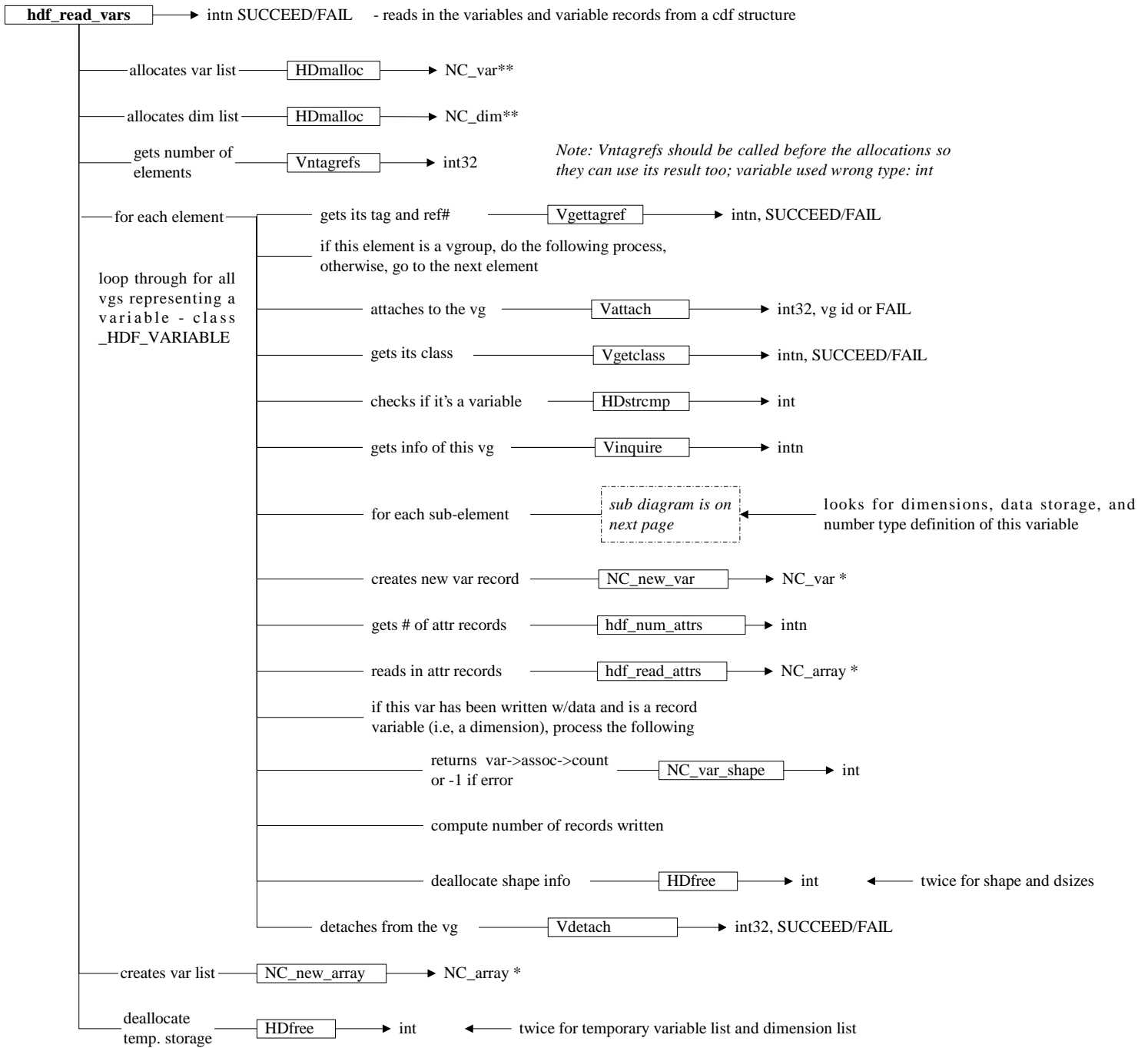

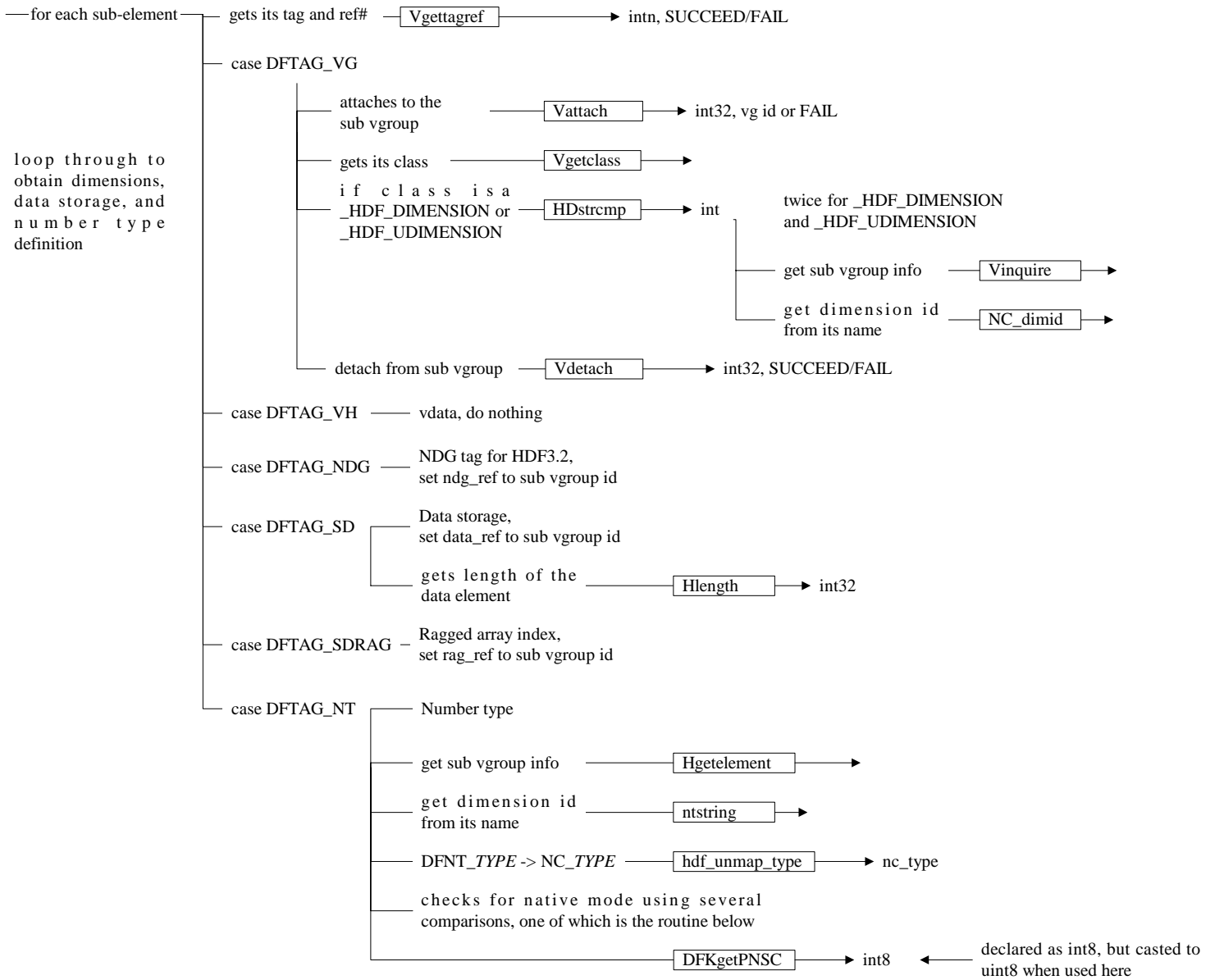

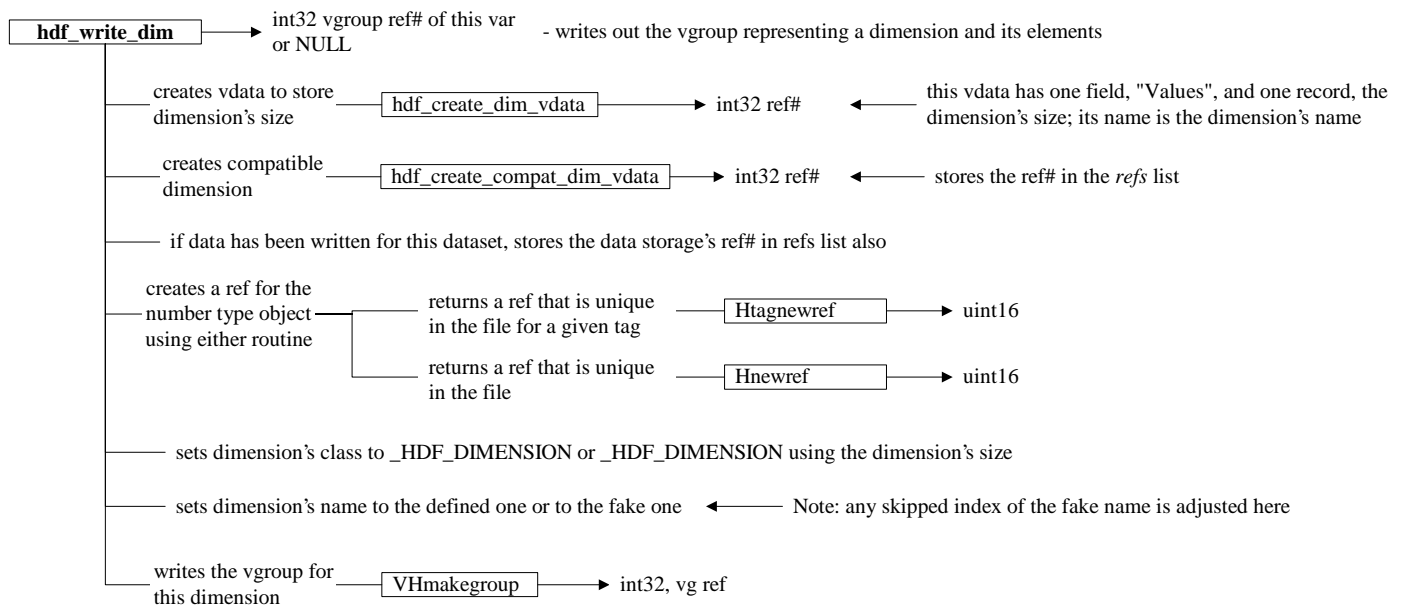
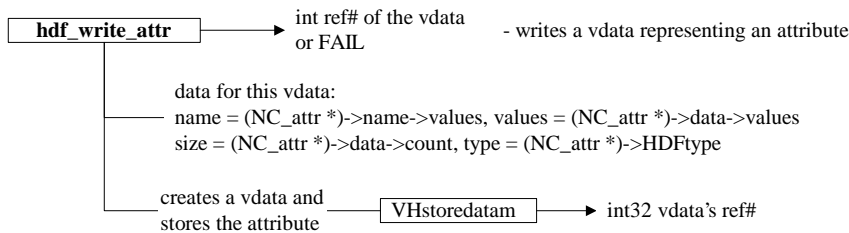
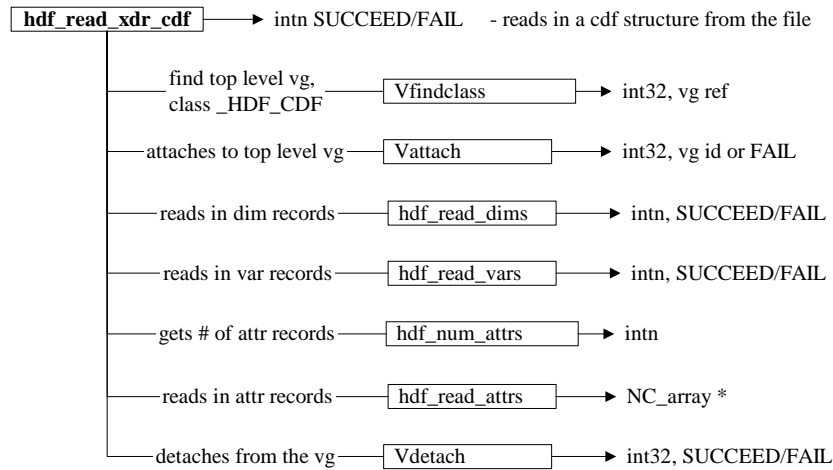

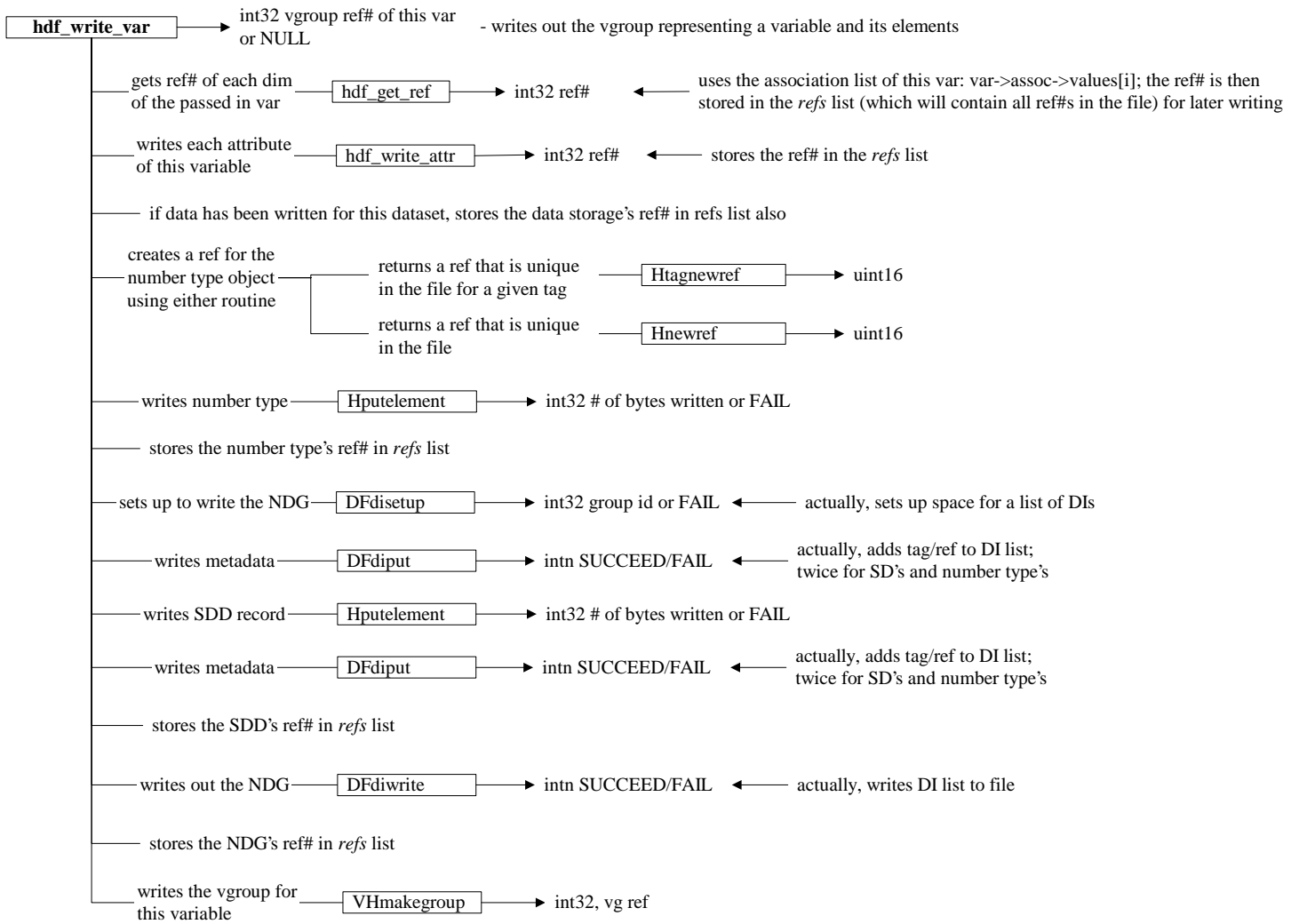

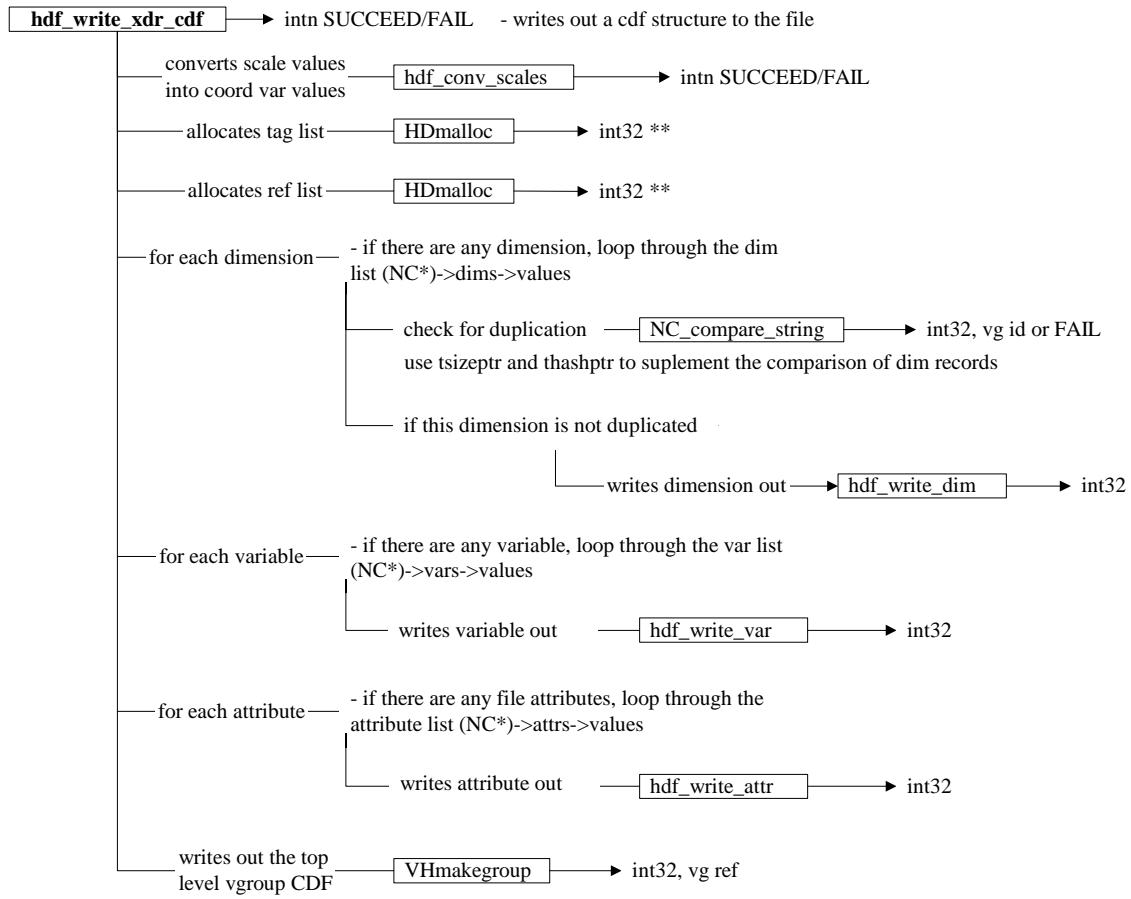

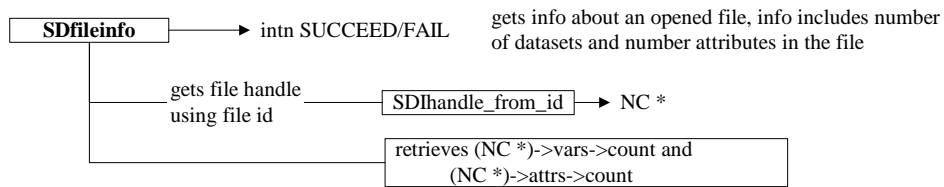
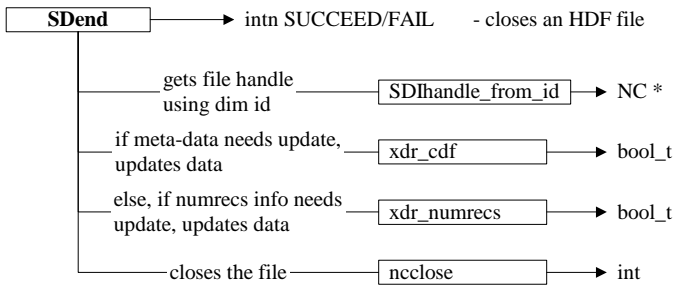
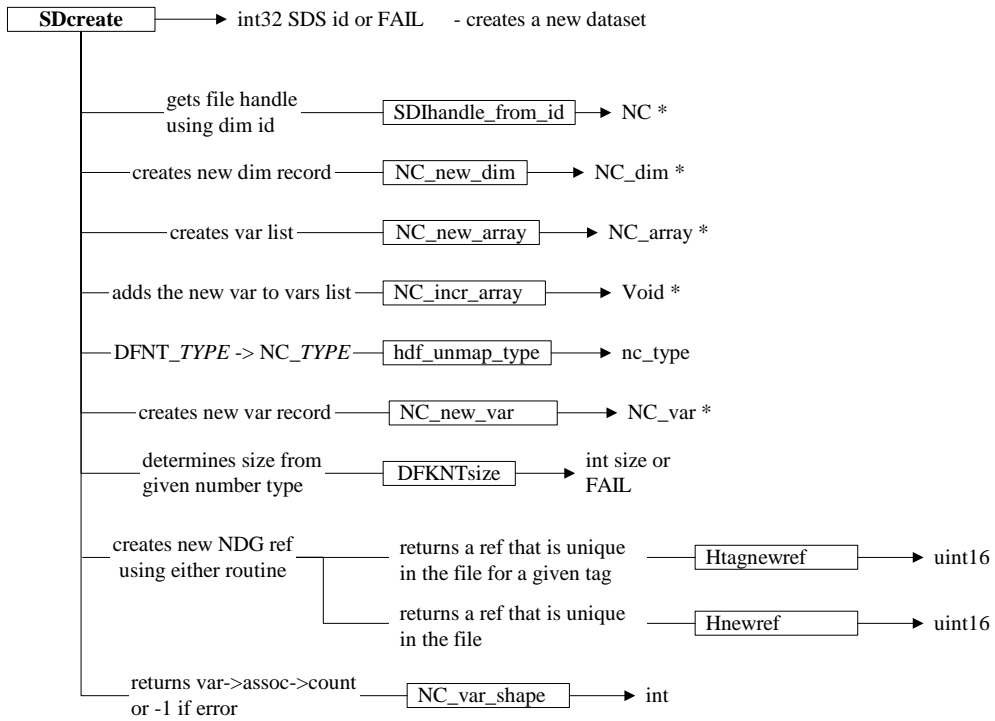

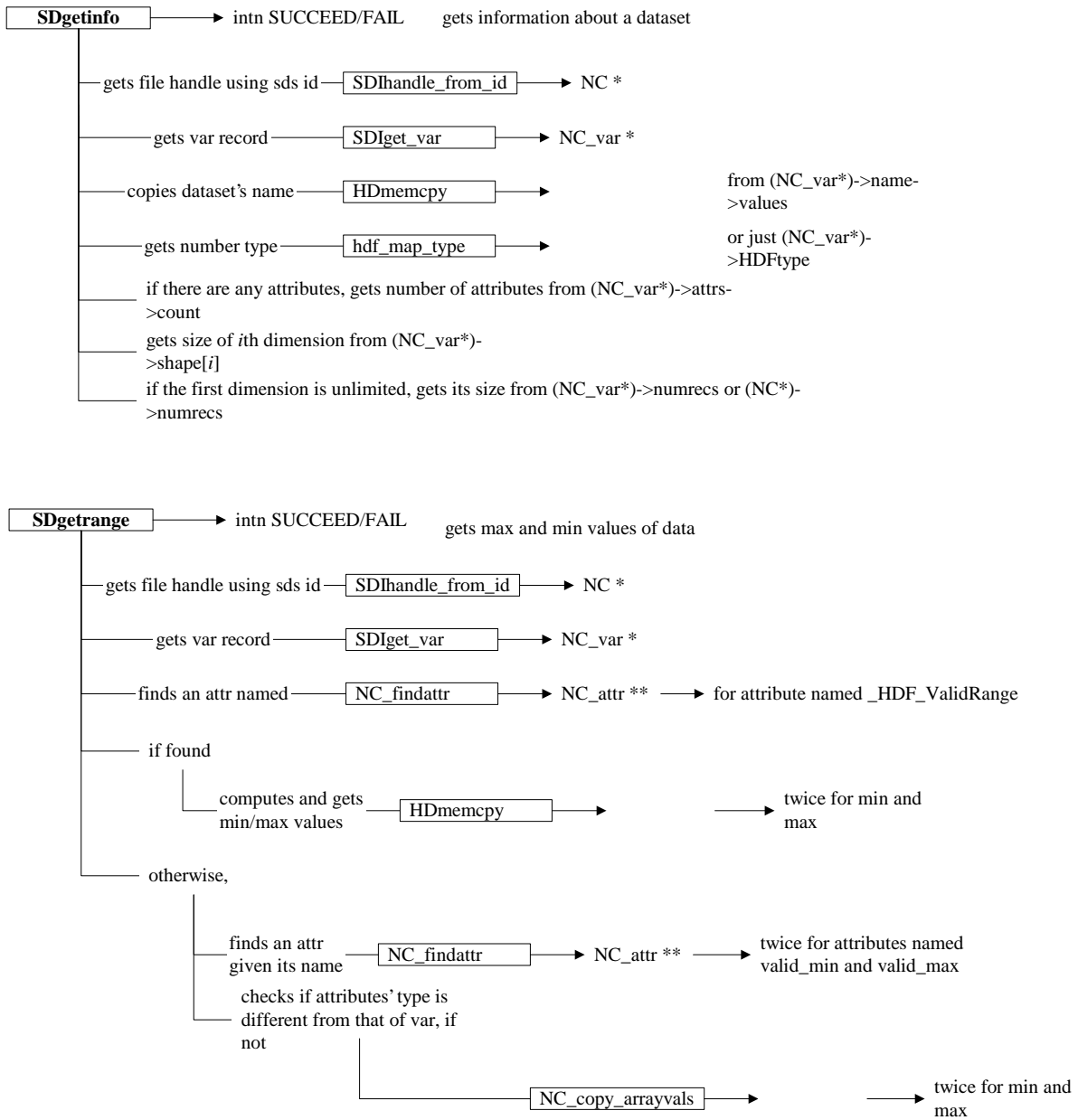

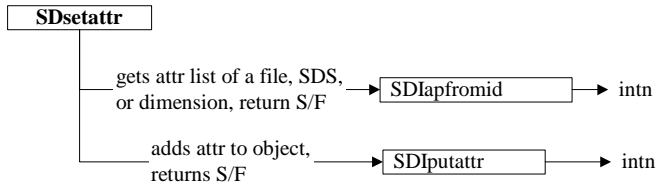
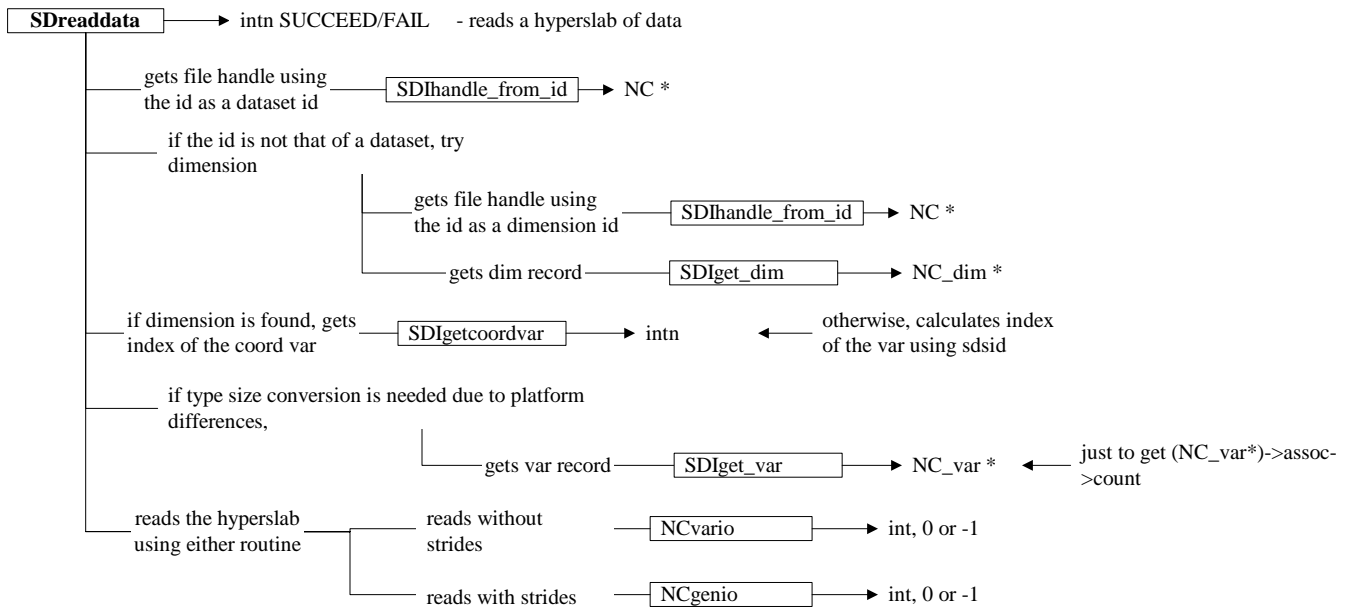
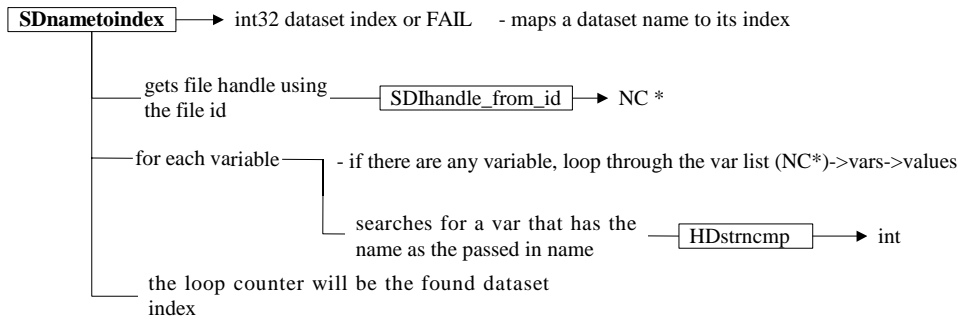

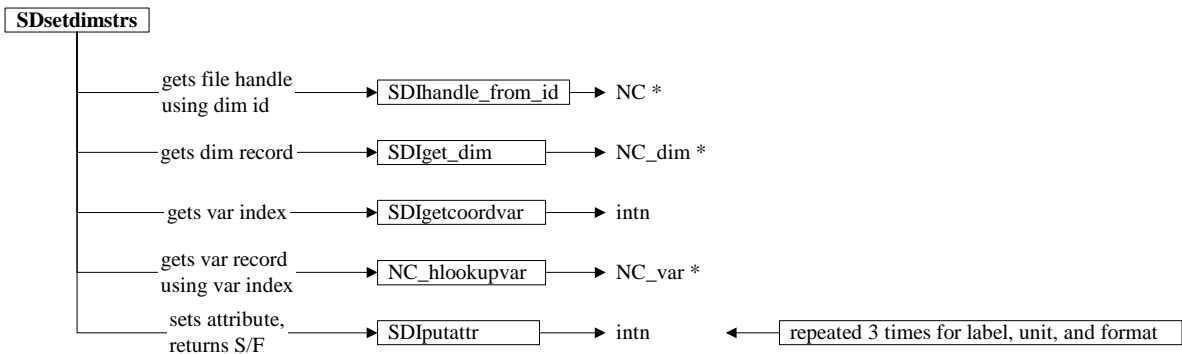
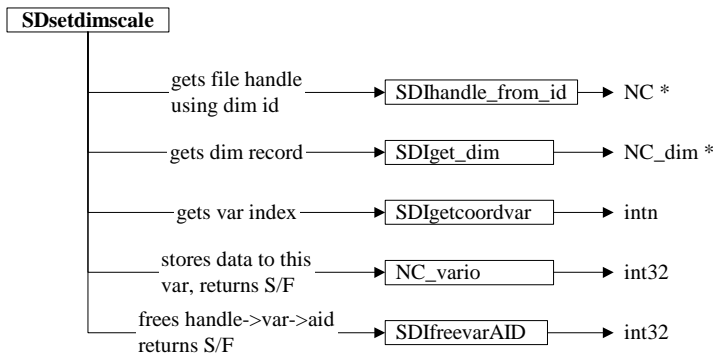
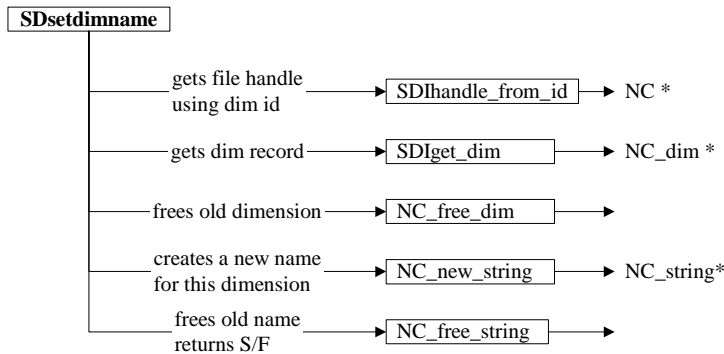
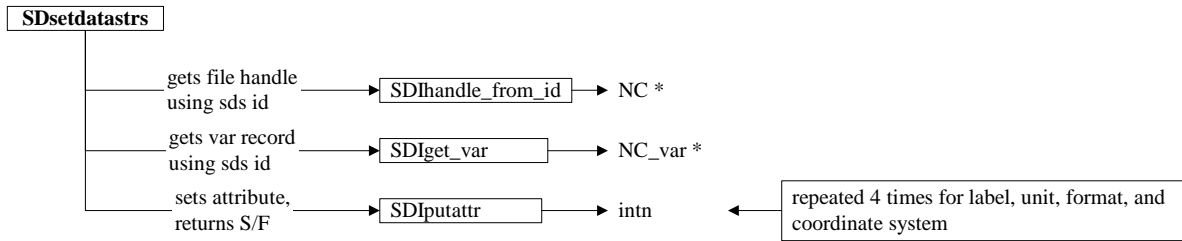

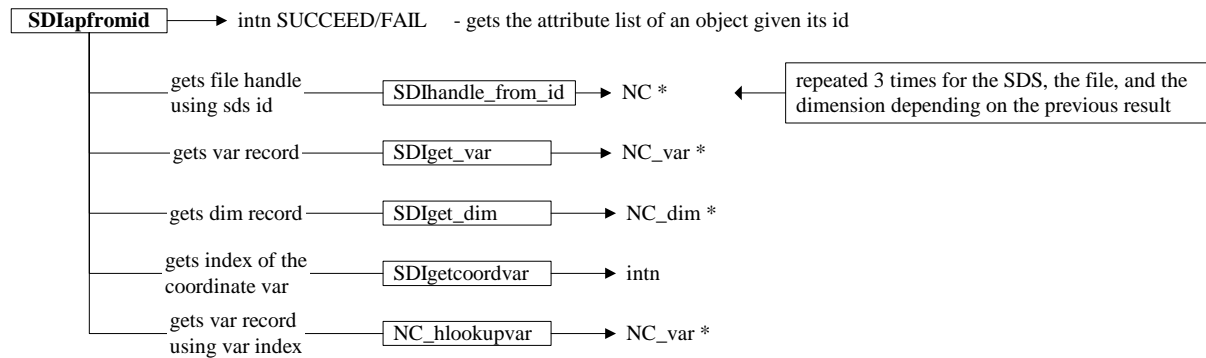
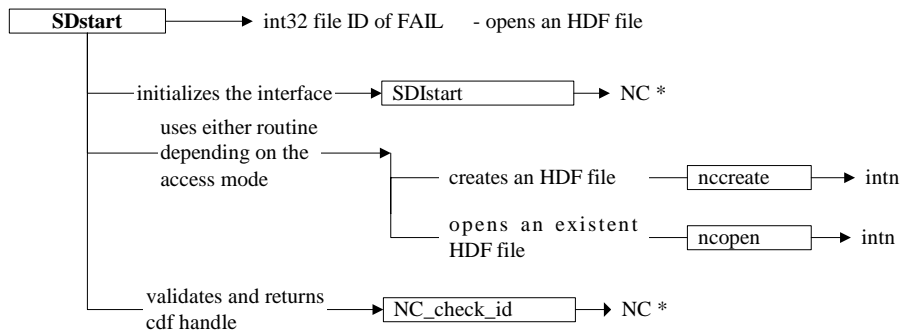
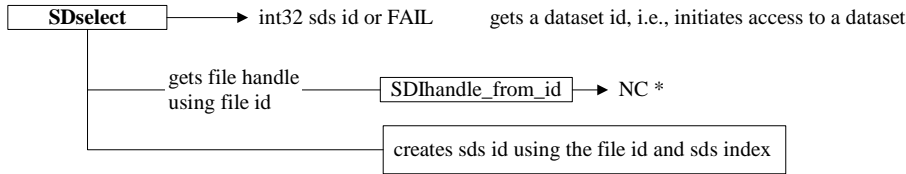
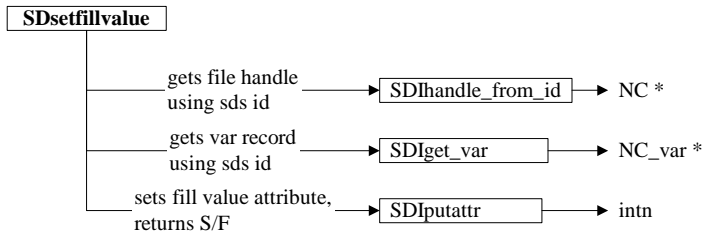

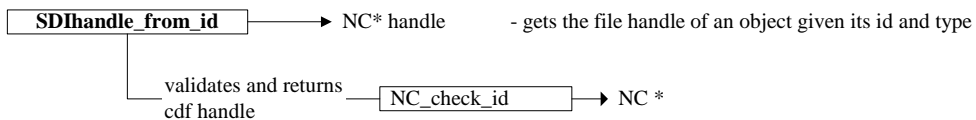
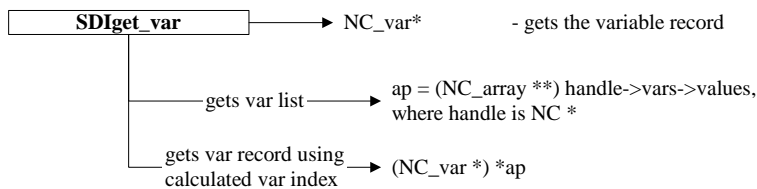
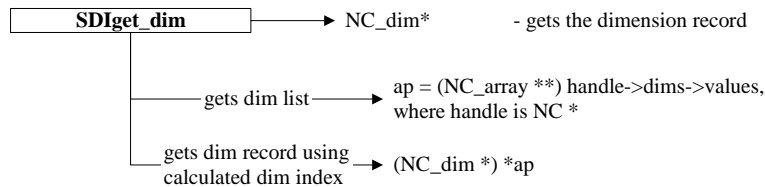
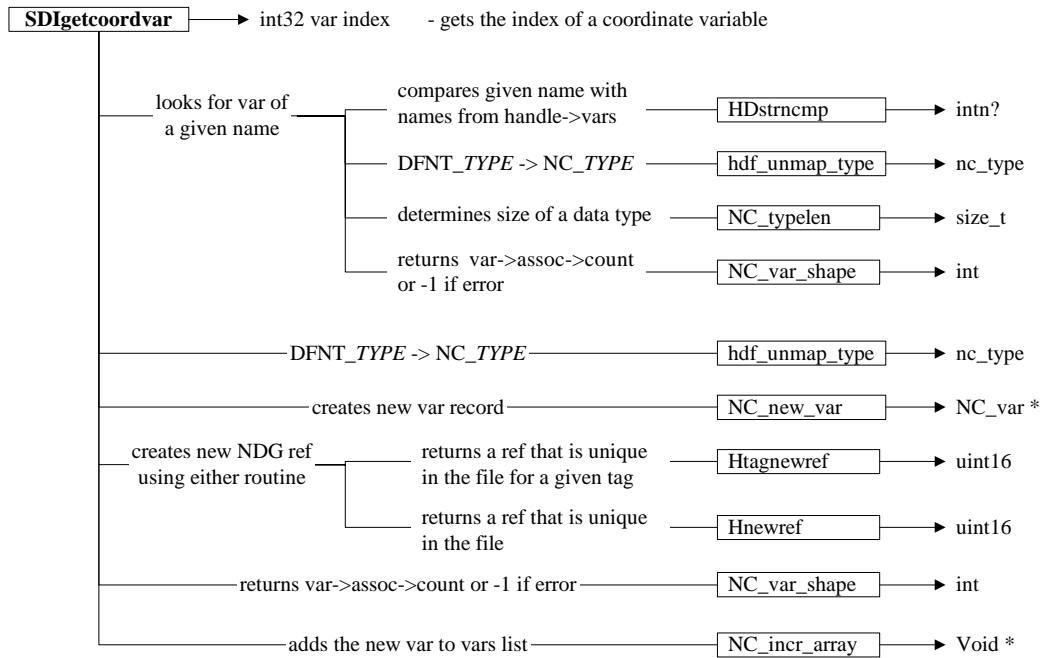

Function Specifications

C.15 Overview

This appendix presents the detailed specifications of selected individual routines of the HDF low level interface. Several low level routines are documented in the *HDF Reference Manual* and all are documented in the distributed source code.

The terms IN: and OUT: indicate whether parameters are input or output parameters; in some cases, a parameter may be both. In the following specifications, these terms should be interpreted as follows:

IN: Value as input parameter
 OUT: Value as output parameter

C.16 Opening and Closing Files

Hopen

```
int32 Hopen(char *path, int access, int16 ndds)
```

path IN: Complete path and name of the file to be opened
access IN: DFACC_READ, DFACC_CREATE, or DFACC_WRITE
ndds IN: Number of DDs in a block if this file needs to be created

Purpose Provides an access path to an HDF file and reads all of the DD blocks in the file into primary memory.

Return value Returns file ID if successful and FAIL (-1) otherwise.

Description Opens an HDF file.

The following events occur on successful exit:

- *File_rec* members are filled in. (*File_rec* is an internal HDF structure containing information about the opened file.)
- The requested file is opened with the relevant permission.
- Information about DDs is set up in memory.
- The file headers and initial information are set up for new files.

Access privilege codes

HDF provides several constants for use as access privilege codes as listed below. Note that these constants are not bit-flags and should not be ORed together to combine access modes. Doing so may cause odd behavior and, in some cases, loss of data:

Recommended tags:

DFACC_READ Open for read only. If file does not exist, error.
DFACC_WRITE Open for read/write. If file does not exist, create it.
DFACC_CREATE Force creation. If file exists, delete it, then open a new file for read/write (in the spirit of the UNIX system command `clobber`).

Obsolete tags:

DFACC_ALL Same as **DFACC_WRITE** (obsolete but still supported).
DFACC_RDWR Same as **DFACC_WRITE** (obsolete but still supported).

Hclose

```
intn Hclose(int32 id)
```

id IN: The identifier of the file to be closed

Purpose Closes the access path to the file.

Return value Returns SUCCEED (0) if successful and FAIL (-1) otherwise.

Description *id* is first validated. If valid, the function closes the access path to the file. If there are still access elements attached to the file, the error `DFE_OPENAID` is pushed onto the error stack and the file is not closed. This is a fairly common error when developing new interfaces. See the discussion of `Hendaccess` below for debugging hints.

C.17 Locating Elements for Access and Getting Information

Hstartread

```
int32 Hstartread(int32 file_id, uint16 tag, uint16 ref)
```

file_id IN: ID of file to attach access element to

tag IN: Tag to search for

ref IN: Reference number to search for

Purpose Locates an existing data element with matching tag/ref and returns an access ID for reading it.

Return value Returns access element ID if successful and FAIL (-1) otherwise.

Description Searches the DDs for a particular tag/ref combination. If the search is successful, an access element is created, attached to the file, and positioned at the start of that data element; otherwise an error is returned. Searching on wildcards begins from the beginning of the DD list. Wildcards can be used for the tag or reference number (DFTAG_WILDCARD and DFREF_WILDCARD) and they match any values.

Hnextread

```
intn Hnextread(int32 access_id, uint16 tag, uint16 ref, int origin)
```

access_id IN: ID of a READ access element

tag IN: Tag to search for

ref IN: Reference number to search for

origin IN: Position at which to start searching

Purpose Locates and positions a read access ID on next occurrence of tag/ref.

Return value Returns SUCCEED (0) if successful and FAIL (-1) otherwise.

Description Searches for the next DD that fits the tag/ref. Wildcards apply. If *origin* is DF_START, searches from start of DD list; if *origin* is DF_CURRENT, searches from current position. Searching from the end of the file via DF_END is not yet implemented.

If the search is successful, then the access element is positioned at the start of that tag/ref; otherwise, the access ID is not modified.

Hstartwrite

```
int32 Hstartwrite(int32 file_id, uint16 tag, uint16 ref, int32 length)
```

file_id IN: ID of file to write to
tag IN: Tag to write to
ref IN: Reference number to write to
length IN: Length of the data element

Purpose Creates or replaces data element with matching tag/ref.

Return value Returns access element ID if successful and FAIL (-1) otherwise.

Description Sets up an access element to write a data element. The DD list of the file is searched first; if the tag/ref is found, the data element can be modified. If an object with the corresponding tag/ref is not found, a new one is created.

Hstartaccess

```
int32 Hstartaccess(int32 file_id, int16 tag, int16 ref, int32 flags)
```

file_id IN: ID of file to read/write to
tag IN: Tag to read/write to
ref IN: Reference number to read/write to
flags IN: Access flags for the data element

Purpose Sets up an access element for either reading or writing.

Return value Returns an access element identifier if successful and FAIL (-1) otherwise.

Description Starts up an access element for either read or write access. The data descriptor list for the file is searched first. If the tag/ref is found, it is not replaced; the seek position is presumed to be at zero (0). If the tag/ref is not found, it is created.

Only a finite number of access elements can be active at a given time, so it is important to call `Hendaccess` whenever you are done using an element.

Hendaccess

```
int32 Hendaccess(int access_id)
```

access_id IN: ID of access element to dispose of

Purpose Disposes of access element for tag/ref.

Return value Returns SUCCEED (0) if successful and FAIL (-1) otherwise.

Description Disposes of an access element. Only a finite number of access elements can be active at a given time, so it is important to call `Hendaccess` whenever you are done using an element.

When developing new interfaces, a common mistake is to fail to call `Hendaccess` for all of the elements accessed. When this happens, `Hclose` will return FAIL and the dump of the error stack (see `HEprint` below) will tell how many access elements are still active.

This can be difficult problem to debug, as the low levels of the HDF library have no idea who or what opened an access element and forgot to release it. A tedious but effective means of debugging this problem is to annotate with comments the locations where the attached count of a file record is changed. This occurs in the files `hfile.c`, `hblocks.c`, and `hextelt.c`.

Hinquire

```
intn Hinquire(int32 access_id, int32 *pfile_id, uint16 *ptag, uint16 *pref,
int32 *plength, int32 *poffset, int32 *pposn, int *paccess,
int16 *pspecial)
```

access_id IN: Access element ID

pfile_id OUT: File ID

ptag OUT: Tag of the element pointed to

pref OUT: Reference number of the element pointed to

plength OUT: Length of the element pointed to

poffset OUT: Offset of element in the file

pposn OUT: Position pointed to within the data element

paccess OUT: Access type of this access element

pspecial OUT: Special code

Purpose Returns access information for a data element.

Return value Returns SUCCEED (0) if the access element points to some data element and FAIL (-1) otherwise.

Description Inquires for the statistics of the data element pointed to by the access element. If a piece of information is not needed, a NULL can be sent in for that value. Convenience macros for calls to `Hinquire` (`HQueryposition`, `HQuerylength`, etc.) are defined in `hdf.h`.

Hishdf

```
int32 Hishdf(char *path)
```

path IN: Complete path and name of file

Purpose Determines whether a file is an HDF file.

Return value Returns TRUE (non-zero) if file is an HDF file and FALSE (0) otherwise.

Description The decision as to whether a file is an HDF file is based solely on the magic number stored in the first four bytes of an HDF file. `Hishdf` may sometimes identify a file as an HDF file that `HOpen` is unable to open (e.g., an HDF file with a corrupted DD list).

Note: `Hishdf` only determines whether a file is an HDF file. It does not verify that the file is readable.

Hnumber

```
int Hnumber(int32 file_id, uint16 tag)
```

file_id IN: File ID

tag IN: Tag to be counted

Purpose Counts the number of occurrences of a tag in a file.

Return value The number of occurrences of a tag in a file.

Hgetlibversion

```
Hgetlibversion(uint32 *majorv, uint32 *minorv, uint32 *release, char string[])
```

<i>majorv</i>	OUT:Major version number
<i>minorv</i>	OUT:Minor version number
<i>release</i>	OUT:Release number
<i>string</i>	OUT:Informational text string

Purpose Gets version information for current HDF library.

Return value Returns SUCCEED (0).

Description Returns the version of the HDF library. The version information is compiled into the HDF library, so it is not necessary to have any open files for this function to execute.

Hgetfileversion

```
Hgetfileversion(uint32 file_id, uint32 *majorv, uint32 *minorv,  
uint32 *release, char *string)
```

<i>file_id</i>	IN: File ID
<i>majorv</i>	OUT:Major version number
<i>minorv</i>	OUT:Minor version number
<i>release</i>	OUT:Release number
<i>string</i>	OUT:Informational text string

Purpose Gets version information for an HDF file.

Return value Returns SUCCEED (0) if successful and FAIL (-1) otherwise.

Description Returns the HDF version information stored in the given file.

C.18 Reading and Writing Entire Data Elements

Hputelement

```
int Hputelement(int32 file_id, uint16 tag, uint16 ref, uint8 *data,
               int32 length)
```

file_id IN: File ID
tag IN: Tag of data element to put
ref IN: Reference number of data element to put
data IN: Pointer to buffer
length IN: Length of data

Purpose Adds or replaces an element in a file.

Return value Returns SUCCEED (0) if successful and FAIL (-1) otherwise.

Description Writes a new data element or replaces an existing data element in a HDF file. Uses `Hwrite` and its associated routines.

Hgetelement

```
int Hgetelement(int32 file_id, uint16 tag, uint16 ref, uint8 *data)
```

file_id IN: ID of the file to read from
tag IN: Tag of data element to read
ref IN: Reference number of data element to read
data OUT: Buffer to read into

Purpose Obtains the data referred to by the passed tag/ref.

Return value Returns SUCCEED (0) if successful and FAIL (-1) otherwise.

Description Reads a data element from an HDF file and puts it into the buffer pointed to by *data*. The space allocated for the buffer is assumed to be large enough.

<p>Note: <code>Hgetelement</code> assumes that the buffer is large enough to hold the data being read. It is the user's responsibility to prevent data loss by ensuring that this is the case.</p>

C.19 Reading and Writing Part of a Data Element

Hread

```
int32 Hread(int32 access_id, int32 length, uint8 *data)
```

access_id IN: Read access element ID
length IN: Length of segment to read in
data OUT: Pointer to data array to read to

Purpose Reads a portion of a data element.

Return value Returns length of segment actually read if successful and FAIL (-1) otherwise.

Description Reads in the next segment in the data element pointed to by the access element. `Hread` starts at the last position left by an `Hread` or `Hseek` call and reads any data that remains in the element up to *length* bytes. If the data element is too short (less than *length* bytes long), `Hread` reads to the end of the data element.

Hwrite

```
int32 Hwrite(int32 access_id, int32 length, uint8 *data)
```

access_id IN: Write access element ID
length IN: Length of segment to write
data IN: Pointer to data to write

Purpose Writes next data segment to data element.

Return value Returns length of segment successfully written and FAIL (-1) otherwise.

Description Writes the data to the data element where the last `Hwrite` or `Hseek` stopped.

`Hwrite` starts at the last position left by an `Hwrite` or `Hseek` call, writes up to a specified number of bytes, and leaves the write pointer at the end of the data written. If the space reserved is less than the length to write, then only as much as can fit is written.

It is the user's responsibility to ensure that no two access elements are writing to the same data element. Note that a user can interlace writes to multiple data elements in the same file.

Hseek

intn Hseek(int32 *access_id*, int32 *offset*, int *origin*)

access_id IN: Access element ID

offset IN: Offset to seek to

origin IN: Position to seek from:

DF_START (0) *offset* from beginning of data element

DF_CURRENT (1) *offset* from current position

DF_END (2) *offset* from end of data element

Purpose Sets the access pointer to an offset within a data element. The next time `Hread` or `Hwrite` is called, the read or write occurs from the new position.

Return value Returns SUCCEED (0) if successful and FAIL (-1) otherwise.

Description Sets the position of an access element in a data element so that the next `Hread` or `Hwrite` will start from that position. *origin* determines the position from which *offset* should be counted.

This routine fails if the access element is not associated with a data element or if the position sought is outside of the data element.

Seeking from the end of a data element is not currently supported.

C.20 Manipulating Data Descriptors

Hdupdd

```
int Hdupdd(int32 file_id, uint16 tag, uint16 ref, uint16 old_tag,  
           uint16 old_ref)
```

file_id IN: File ID

tag IN: Tag of new data descriptor

ref IN: Reference number of new data descriptor

old_tag IN: Tag of data descriptor to duplicate

old_ref IN: Reference number of data descriptor to duplicate

Purpose Generates new references to data that is already referenced from somewhere else.

Return value Returns SUCCEED (0) if successful and FAIL (-1) otherwise.

Description Duplicates a data descriptor so that the new tag/ref points to the same data element pointed to by the old tag/ref.

Hdeldd

```
int Hdeldd(int32 file_id, uint16 tag, uint16 ref)
```

file_id IN: File ID

tag IN: Tag of data descriptor to delete

ref IN: Reference number of data descriptor to delete

Purpose Deletes a tag/ref from the list of DDs.

Return value Returns SUCCEED (0) if successful and FAIL (-1) otherwise.

Description Deletes the data descriptor of tag/ref from the DD list of the file. This routine is unsafe and may leave a file in a condition that is not usable by some routines. Use with care.

Hnewref

uint16 Hnewref(int32 *file_id*)

file_id IN: File ID

Purpose Returns the next available reference number.

Return value Returns the reference number if successful and 0 otherwise.

Description Returns a reference number that can be used with any tag to produce a unique tag/ref. Successive calls to `Hnewref` will generate a strictly increasing sequence until the highest possible reference number has been returned; then `Hnewref` will return unused reference numbers starting from 1.

C.21 Managing Special Data Elements

HLcreate

```
int32 HLcreate(int32 file_id, uint16 tag, uint16 ref, int32 block_length,
              int32 number_blocks)
```

file_id IN: File ID

tag IN: Tag of new data element (or object)

ref IN: Reference number of new data element (or object)

block_length
IN: Length of blocks to be used

number_blocks
IN: Number of blocks to use per linked block record

Purpose: Creates a new linked block special data element.

Return value Returns access ID for special data element if successful and FAIL (-1) otherwise.

Description Appending to existing HDF elements was a problem prior to HDF Version 3.2 because HDF objects had to be stored contiguously. When appending, the HDF library forced the user to delete the existing element and rewrite it at the end of the file. HDF Version 3.2 introduced the concept of linked blocks, which allow unlimited appending to existing elements without copying over existing data.

This routine can be used to create an object with the given tag/ref as a linked block element or to promote an existing element to be stored in linked blocks.

Initially, a table is set up to accommodate *number_blocks* linked blocks for the specified data object. Each block has *block_length* bytes. If an existing object is being promoted, *block_length* does not have to be the same size as the original element.

HLcreate returns an active access ID with write permission to the linked block element.

HLsetblockinfo

```
intn HLsetblockinfo(int32 access_id, uint32 block_size, uint32 num_blocks)
```

access_id IN: Access record identifier
block_size IN: Block size in bytes
num_blocks IN: Number of linked blocks

Purpose Sets block size and number of blocks for a linked block element.

Return value Returns SUCCEED (0) if successful and FAIL (-1) otherwise.

Description Sets the block size and the number of linked blocks for a linked block data element. Unless reset by this function, *block_size* and *num_blocks* will have the default values defined in HDF_APPENDABLE_BLOCK_LEN and HDF_APPENDABLE_BLOCK_NUM, respectively.

Passing in the value -1 for either parameter indicates that the respective field is not to be changed.

An error will occur if the value of either parameter is set to 0 or any negative value other than -1.

This routine is used by **VSsetblocksize** and **VSsetnumblocks**.

HLgetblockinfo

```
intn HLgetblockinfo(int32 access_id, uint32 *block_size, uint32 *num_blocks)
```

access_id IN: Access record identifier
block_size OUT: Block size in bytes
num_blocks OUT: Number of linked blocks

Purpose Retrieves block size and number of blocks for a linked block element.

Return value Returns SUCCEED (0) if successful and FAIL (-1) otherwise.

Description Retrieves the block size and the number of linked blocks for a linked block data element.

If no response is desired for either value, *block_size* or *num_blocks* may be set to NULL.

This routine is used by **VSgetblockinfo**.

HXcreate

```
int32 HXcreate(int32 file_id, uint16 tag, uint16 ref, char *extern_file_name)
```

file_id IN: file record ID

tag IN: Tag of the special data element to create or promote

ref IN: Reference number of the special data element to create/promote

extern_file_name
IN: name of the external file to use for the data element

Purpose Creates a new external file special data element.

Return value Returns access ID for special data element if successful and FAIL (-1) otherwise.

Description Creates a new element in an external file or promotes an existing element to be stored in an external file. If an existing element is to be promoted, it is deleted (using Hdeldd) from the original file and copied into the new external file.

Distributing a single object over multiple external files is not currently supported. In addition, one cannot place multiple objects in the same external file.

This routine returns an active access ID with write permission to the external element.

C.22 Data Set Chunking

HMCcreate

```
int32 HMCcreate(int32 file_id, uint16 tag, uint16 ref,
               uint8 nlevels, int32 fill_val_len, void *fill_val,
               HCHUNK_DEF *chk_array)
```

Purpose

Creates a chunked element.

Description

HMCcreate promotes an HDF element to a chunked element.

The HDF element specified by **HMCcreate** becomes a chunked element allowing data to be easily appended to the element. Chunk records are stored in a Vdata.

All of the pieces of the chunked element are the same size from the stand point of the element. If compression is used then each chunk is compressed and the compression layer takes care of it as the chunk layer sees each chunks as a seperate HDF object (DFTAG_CHUNK). The proper compression special header needs to be passed to the compression layer.

The Vdata (chunk table) is made appendable with a linked-block table size of 128.

This routine also creates the chunk cache for the chunked element. The cache is initialized with the physical size of each chunk, the number of chunks in the object, i.e. the object size divided by the chunk size, and the maximum number of chunks to cache in memory. Chunks in the cache are dealt with by their number, i.e. by translating the `origin` of the chunk to a unique number. The default maximum number of chunks in the cache is set to the number of chunks along the last dimension.

NOTE: The cache itself could be used to cache any object into a number of fixed size chunks so long as the read/write(page-in/page-out) routines know how to deal with getting the correct chunk based on a number. These routines can be found in `mcache.c`.

Parameters

<i>file_id</i>	IN: File to put chunked element in
<i>tag</i>	IN: Tag of element
<i>ref</i>	IN: Reference number of element
<i>nlevels</i>	IN: Number of levels of chunks
<i>fill_val_len</i>	IN: Fill value length in bytes
<i>fill_val</i>	IN: Fill value
<i>chk_array</i>	IN: Structure describing chunk distribution

Return Values

If the chunked element already exists, **HMCcreate** returns `FAIL`. Otherwise a new element is created and **HMCcreate** returns the AID of the newly-created chunked element.

HMCwriteChunk

```
int32 HMCwriteChunk(int32 access_id, int32 *origin, const void *datap)
```

Purpose

Writes out exactly one chunk.

Description

HMCwriteChunk writes out exactly one chunk of data to a chunked element.

This function is used to complete whole chunks to the file based on the chunk origin, the position of the chunk in the overall chunk array.

Parameters

access_id IN: Access AID of the specified chunk.

origin IN: Origin of the chunk to be written.

datap IN: Buffer for the data to be written.

Return Values

Returns the number of bytes written if successful; otherwise returns FAIL.

HMCreadChunk

```
int32 HMCreadChunk(int32 access_id, int32 *origin, void *datap)
```

Purpose

Reads exactly one chunk.

Description

HMCreadChunk reads exactly one chunk from a chunked element.

This function is used to read complete chunks from the file based on the chunk origin, the position of the chunk in the overall chunk array.

Parameters

access_id IN: Access AID for the specified chunk.

origin IN: Origin of chunk to be read.

datap IN: Buffer for the data to be read.

Return Values

Returns the number of bytes read if successful; otherwise FAIL.

HMCsetMaxcache

```
int32 HMCsetMaxcache(int32 access_id, int32 maxcache, int32 flags)
```

Purpose

Sets the maximum number of chunks to cache.

Description

HMCsetMaxcache sets the maximum number of chunks to cache.

The values set here affects the current object's caching behaviour.

If the chunk cache is full and *maxcache* is greater than the current *maxcache* value, then the chunk cache is reset to the new *maxcache* value, else the chunk cache remains at the current *maxcache* value.

If the chunk cache is not full, then the chunk cache is set to the new *maxcache* value only if the new *maxcache* value is greater than the current number of chunks in the cache.

Use flags argument of *HMC_PAGEALL* if the whole object is to be cached in memory; otherwise pass in zero.

NOTES: This function calls the routine **mcache_set_maxcache()**. The value of *maxcache* must be greater than 1.

Parameters

access_id IN: Access AID for the specified chunked element.
maxcache IN: Maximum number of chunks to cache.
flags IN: Valid flags are 0 (zero) and *HMC_PAGEALL*.

Returns

Returns the new value of *maxcache* if successful; otherwise returns *FAIL*.

HMCPstwrite

```
int32 HMCPstwrite(accrec_t *access_rec)
```

Purpose

Opens an access record of a chunked element for writing.

Description

HMCPstwrite calls **HMCistaccess()** to fill in the access record for writing.

Parameter

access_rec IN: Access record to fill in.

Return Values

Returns the AID of the access record if successful; otherwise returns *FAIL*.

HMCPseek

```
int32 HMCPseek(accrec_t *access_rec, int32 offset, int origin)
```

Purpose

Sets the seek position in the chunked element.

Description

HMCPseek sets the seek position in the specified chunked element.

Parameters

access_rec IN: Access record for the specified chunk.
offset IN: Seek offset.
origin IN: Location from which the offset should be calculated.

Return Values

Returns a positive value if successful; otherwise returns `FAIL`.

HMCPchunkread

```
int32 HMCPchunkread(void *cookie, int32 chunk_num, void *datap)
```

Purpose

Reads a chunk.

Description

Given the chunk number, **HMCPchunkread** reads in a complete chunk from a chunked element.

This is used as the *page-in-chunk* routine for the cache.

Only the cache should call this routine.

Parameters

cookie IN: Access record for the desired chunk.
chunk_num IN: Chunk to be read.
datap OUT: Buffer for data to be read.

Return Values

Returns the number of bytes read if successful; otherwise returns `FAIL`.

HMCPread

```
int32 HMCPread(accrec_t *access_rec, int32 length, void *datap)
```

Purpose

Reads data from a chunked element.

Description

HMCPread reads in data from a chunked element.

Data is obtained from the cache, which takes care of reading in the proper chunks to satisfy the request.

Parameters

access_rec IN: Access record for the desired chunk.

length IN: Number of bytes to read.

datap OUT: Buffer for data to be read.

Return Values

Returns the number of bytes read if successful; otherwise returns `FAIL`.

HMCPchunkwrite

```
int32 HMCPchunkwrite(void *cookie, int32 chunk_num, const void *datap)
```

Purpose

Writes out exactly one chunk.

Description

Given the chunk number, **HMCPchunkwrite** writes a complete chunk to a chunked element.

This is used as the *page-out-chunk* routine for the cache.

Only the cache should call this routine.

Parameters

cookie IN: Access record for the chunk to be written.

chunk_num IN: Chunk number.

datap IN: Buffer for the data to be written.

Return Values

Returns the number of bytes written if successful; otherwise returns `FAIL`.

HMCPwrite

```
int32 HMCPwrite(accrec_t *access_rec, int32 length, const void *datap)
```

Purpose

Writes data to a chunked element.

Description

HMCPwrite writes data to a chunked element.

Data is obtained from the cache, which takes care of obtaining the proper chunks to write to satisfy the request.

The chunks are marked as dirty before being returned to the cache.

Parameters

access_rec IN: Access record for the chunked element.
length IN: Number of bytes to be written.
datap IN: Buffer for the data to be written.

Return Values

Returns the number of bytes written if successful; otherwise returns FAIL.

HMCPcloseAID

```
int32 HMCPcloseAID(accrec_t *access_rec)
```

Purpose

Closes file but keeps AID active.

Description

HMCPcloseAID closes the file currently pointed to by this AID but does not free the AID.

This will flush the chunk cache and free up the special information struct.

This function is called by **Hnextread()**, which reuses an AID to point to the *next object*, as requested. If the current object was a chunked object, the chunked information needs to be closed before all reference to it is lost.

NOTE: Direct use of **Hnextread()** is not recommended since it relies on previous state information.

Parameter

access_rec IN: Access record of file to close.

Return Values

Returns a positive value if successful; otherwise returns FAIL.

HMCPendaccess

`intn HMCPendaccess(accrec_t *access_rec)`

Purpose

Closes a chunk element AID.

Description

HMCPendaccess closes the specied AID, freeing up all of the space used to store information about a chunked element and updating the proper records, `access_rec`, `file_rec`, etc. All relevant information is flushed.

Parameter

`access_rec` IN: Access record to close.

Return Values

Returns a positive value if successful; otherwise returns `FAIL`.

HMCPinfo

`int32 HMCPinfo(accrec_t *access_rec, sp_info_block_t *info_chunk)`

Purpose

Returns information about a chunked element.

Description

HMCPinfo returns information about the given chunked element.

`info_chunk` is assumed to be non-NULL.

Parameters

`access_rec` IN: access record of access element

`info_chunk` OUT: Information about the special element.

Return Values

Returns a positive value if successful; otherwise returns `FAIL`.

HMCPinquire

```
int32 HMCPinquire(accrec_t *access_rec, int32 *pfile_id, uint16 *ptag,  
                 uint16 *pref, int32 *plength, int32 *poffset,  
                 int32 *pposn, int16 *paccess, int16 *pspecial)
```

Purpose

Inquires for chunked elements.

Description

HMCPinquire returns interesting information about a chunked element.

NULL can be passed for any OUT parameter if the value is not needed.

Parameters

<i>access_rec</i>	IN: Access record of the chunked element for which information is sought.
<i>pfile_id</i>	OUT: File identifier.
<i>ptag</i>	OUT: Tag of information record.
<i>pref</i>	OUT: Reference number of information record.
<i>plength</i>	OUT: Length of element.
<i>poffset</i>	OUT: Offset of element -- meaningless.
<i>pposn</i>	OUT: Current position in element.
<i>paccess</i>	OUT: Access mode.
<i>pspecial</i>	OUT: Special code.

Return Values

Returns a positive value if successful; otherwise returns FAIL.

C.23 Development Routines

HDgettagname

char *HDgettagname(uint16 *tag*)

tag IN: Tag to look up

Purpose Gets a meaningful description of a tag.

Return value Returns a pointer to a string describing this tag or NULL if the tag is unknown.

Description To reduce the amount of duplicated code, this routine can be used to map a tag to a character string containing the name of the tag.

The string returned by this routine is guaranteed to be 30 characters or less.

HDgetspace

void *HDgetspace(uint32 *qty*)

qty IN: Number of bytes to allocate

Purpose Allocates space.

Return value If successful, returns a pointer to space that was allocated; otherwise returns NULL .

Description Uses an appropriate allocation routine on the local machine to get space.

HDfreespace

void *HDfreespace(void **ptr*)

ptr IN: Pointer to previously-allocated space that is to be freed

Purpose Frees space.

Return value Returns NULL.

Description Uses an appropriate routine on the local machine to free space. This routine is platform dependent.

HDstrncpy

```
char *HDstrncpy(register char *dest, register char *source, int32 length)
```

dest OUT: Pointer to area to copy string to

source IN: Pointer to area to copy string from

length IN: Maximum number of bytes to copy

Purpose Copies a string with maximum length *length*.

Return value Returns address of *dest*.

Description Creates a string in *dest* that is at most *length* characters long. The number of characters must *include* the NULL terminator for historical reasons. Hence, if you are working with the string `Foo`, you must call this copy function with the value `4` (three characters plus the NULL terminator) in *length*.

C.24 Error Reporting

HEprint

```
void HEprint(FILE *stream, int32 level)
```

stream IN: Stream to print error messages on

level IN: Level of the error stack to print

Purpose Prints information on the error stack.

Return value Has no return value.

Description Prints information on reported errors. If *level* is zero, all of the errors currently on the error stack are printed. Output from this function is sent to the file pointed to by *stream*.

The following information is printed:

- An ASCII description of the error
- The reporting routine
- The reporting routine's source file name
- The line at which the error was reported

If the programmer has supplied extra information by means of `HEreport`, this information is printed as well.

HEclear

```
void HEclear(void)
```

Purpose Clears all information on reported errors off of the error stack.

Return value Has no return value.

Description Clears all of the information off of the error stack.

HERROR

```
void HERROR(int16 number)
```

number IN: Error number

Purpose Reports an error.

Return value Has no return value.

Description Reports an error. Any function calling `HERROR` must have a variable `FUNC` which points to a string containing the name of the function.

`HERROR` is implemented as a macro.

HEreport

```
void HEreport(char *format, ...)
```

format IN: `printf`-style format and arguments

Purpose Provides extra information to the error reporting routines.

Return value Has no return value.

Description Provides further annotation to an error report. Only one such annotation is remembered for each error report. The arguments to this routine follow the style of `printf`.

Consider the following example from `hfile.c`:

```
char *FUNC = "Hclose";
....
if (file_rec->attach > 0) {
    file_rec->refcount++;
    HERROR(DFE_OPENAID);
    HEreport("There are still %d active aids attached", file_rec->attach);
    return FAIL;
}
```

C.25 Other

Hsync

int Hsync(int32 *file_id*)

file_id IN: ID of the file to synchronize

Purpose Synchronizes on-disk HDF file with image in memory.

Return value Returns SUCCEED.

Description `Hsync` is not included in the current HDF library release because the on-disk representation of an HDF file is always the same as its in-memory representation. `Hsync` will be provided when future releases implement buffering schemes.